

AQ3130 Series 0.3pF 10 kV Bidirectional Discrete TVS

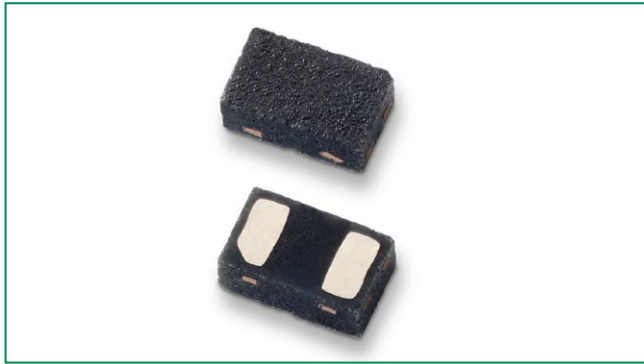

Description

The AQ3130 includes back-to-back TVS diodes fabricated in a proprietary silicon avalanche technology to provide protection for electronic equipment that may experience destructive electrostatic discharges (ESD). These robust diodes can safely absorb repetitive ESD strikes up to the maximum level specified in IEC 61000-4-2 international standard without performance degradation. These back-to-back components provide symmetric protection with or without AC being present.

Pinout

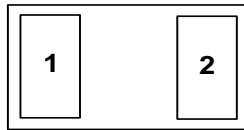

Features

- ESD protection of $\pm 10\text{kV}$ contact discharge, $\pm 15\text{kV}$ air discharge, (IEC 61000-4-2)
- EFT protection, IEC 61000-4-4, 40A ($t_p=5/50\text{ns}$)
- Lightning, 2A (8/20 as defined in IEC 61000-4-5 2nd edition)
- PPAP capable
- Low capacitance of 0.3pF @ $V_R=0\text{V}$
- Low leakage current of 50nA (max) at 28V
- Space efficient SOD882 footprint
- AEC-Q101 qualified
- Halogen free, lead free and RoHS compliant
- Moisture Sensitivity Level(MSL -1)

Functional Block Diagram

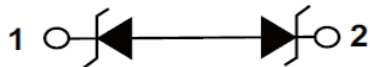

Applications

- Tablets
- Ultrabook
- eReader
- Smart Phones
- Digital Cameras
- MP3/ PMP
- Set Top Boxes
- Portable Medical
- NFC and FeliCa
- Automotive applications

Absolute Maximum Ratings

Symbol	Parameter	Value	Units
I_{PP}	Peak Current ($t_p=8/20\mu s$)	2.0	A
T_{OP}	Operating Temperature	-40 to 150	°C
T_{STOR}	Storage Temperature	-55 to 150	°C

CAUTION: Stresses above those listed in "Absolute Maximum Ratings" may cause permanent damage to the component. This is a stress only rating and operation of the component at these or any other conditions above those indicated in the operational sections of this specification is not implied.

Electrical Characteristics ($T_{OP}=25^\circ C$)

Parameter	Symbol	Test Conditions	Min	Typ	Max	Units
Reverse Standoff Voltage	V_{RWM}	$I_R=1\mu A$	-	-	28	V
Reverse Leakage Current	I_{LEAK}	$V_R=28V$ with 1 pin at GND	-	1	50	nA
Clamp Voltage ¹	V_C	$I_{PP}=1A, t_p=8/20\mu s$, Fwd	-	39	44	V
		$I_{PP}=2A, t_p=8/20\mu s$, Fwd	-	42	48	V
ESD Withstand Voltage ¹	V_{ESD}	IEC 61000-4-2 (Contact)	±10	-	-	kV
		IEC 61000-4-2 (Air)	±15	-	-	kV
Dynamic Resistance ²	R_{DYN}	TLP, $t_p=100ns$, I/O to GND	-	1.0	-	Ω
Diode Capacitance ¹	$C_{I/O-I/O}$	Reverse Bias=0V, f=1 MHz	-	0.3	0.45	pF

Note: 1. Parameter is guaranteed by design and/or component characterization.

2. Transmission Line Pulse (TLP) with 100ns width, 2ns rise time, and average window $t_1=70ns$ to $t_2=90ns$

8/20μs Pulse Waveform

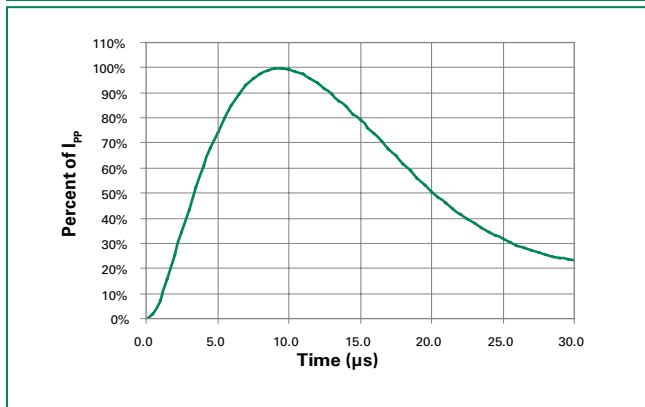

Capacitance vs. Reverse Bias

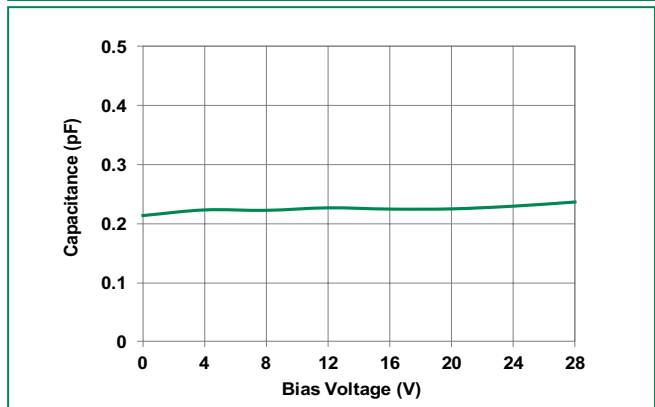

Transmission Line Pulsing (TLP) Plot

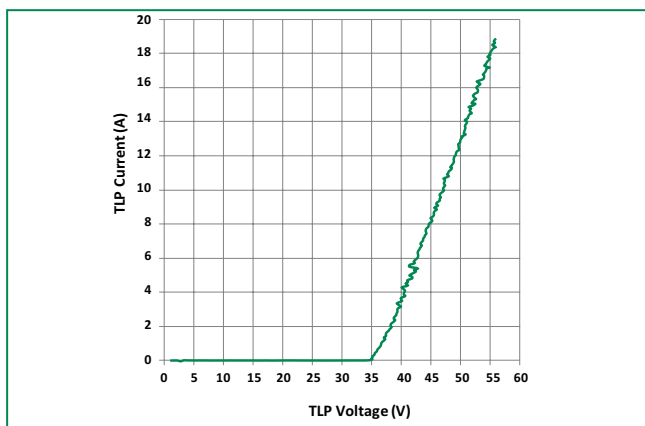

Insertion Loss (S21)

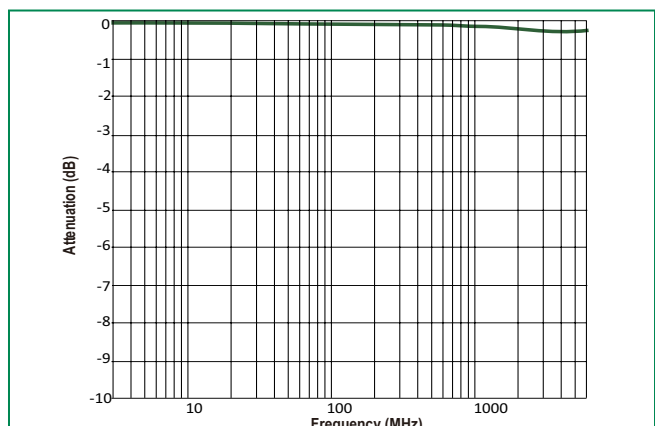

Soldering Parameters

Reflow Condition	Pb – Free assembly	
Pre Heat	- Temperature Min ($T_{s(min)}$)	150°C
	- Temperature Max ($T_{s(max)}$)	200°C
	- Time (min to max) (t_s)	60 – 180 secs
Average ramp up rate (Liquidus) Temp (T_L) to peak	3°C/second max	
$T_{s(max)}$ to T_L - Ramp-up Rate	3°C/second max	
Reflow	- Temperature (T_L) (Liquidus)	217°C
	- Temperature (t_L)	60 – 150 seconds
Peak Temperature (T_p)	260 ^{+0/-5} °C	
Time within 5°C of actual peak Temperature (t_p)	20 – 40 seconds	
Ramp-down Rate	6°C/second max	
Time 25°C to peak Temperature (T_p)	8 minutes Max.	
Do not exceed	260°C	

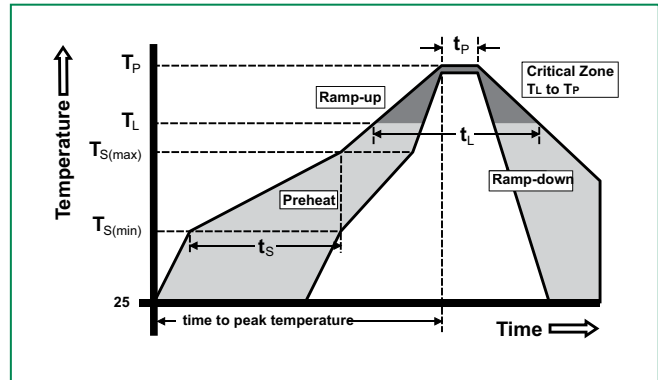

Product Characteristics

Lead Plating	Pre-Plated Frame
Lead Material	Copper Alloy
Substrate material	Silicon
Body Material	Molded Compound
Flammability	UL Recognized compound meeting flammability rating V-0

Part Numbering System

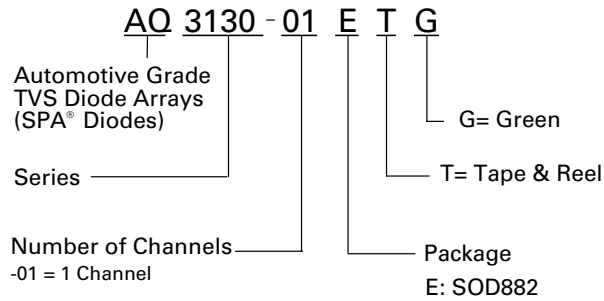

Part Marking System

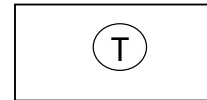

Ordering Information

Part Number	Package	Min. Order Qty.
AQ3130-01ETG	SOD882	10000

Package Dimensions — SOD882

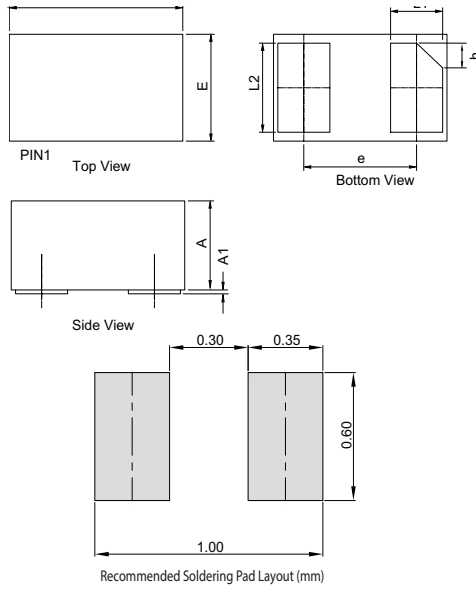

Symbol	Dimensions		
	Min	Nor.	Max
A	0.45	0.50	0.55
A1	0.00	0.02	0.05
L1	0.20	0.25	0.30
L2	0.45	0.50	0.55
D	0.95	1.00	1.05
E	0.55	0.60	0.65
e	0.65BSC		
h	0.07	0.12	0.17

Embossed Carrier Tape & Reel Specification — SOD882

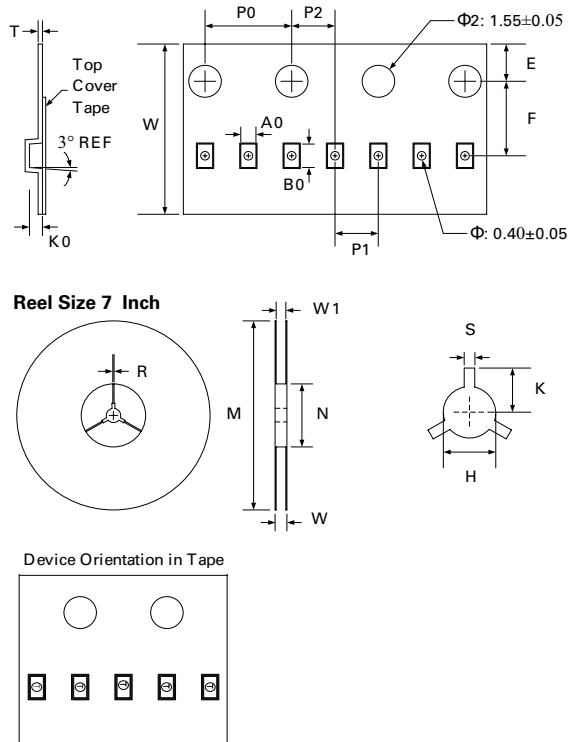

Symbol	Tape Dimensions	
	Millimetres	
	Min	Max
A0	0.65	0.75
B0	1.10	1.20
K0	0.50	0.60
E	1.65	1.85
F	3.45	3.55
P0	3.90	4.10
P1	1.90	2.10
P2	1.95	2.05
T	1.95	2.05
W	7.90	8.10

Symbol	Reel Dimensions (Size $\Phi 178$)	
	Millimetres	
	Min	Max
M	177.0	179.0
N	59.0	61.0
W	11.0	12.0
W1	8.5	9.5
H	12.5	13.5
S	1.9	2.1
K	10.8	11.2
R	0.95	1.05

Disclaimer Notice - Information furnished is believed to be accurate and reliable. However, users should independently evaluate the suitability of and test each product selected for their own applications. Littelfuse products are not designed for, and may not be used in, all applications. Read complete Disclaimer Notice at <http://www.littelfuse.com/disclaimer-electronics>.