

THIS DOCUMENT IS SUBJECT TO CHANGE WITHOUT NOTICE. IT IS CONFIDENTIAL AND A PROPERTY OF Amphenol LTW. DISCLOSURE TO THIRD PARTY HAS TO BE AUTHORIZED BY Amphenol LTW.

REV.	ECN NO.	DATE	SIGN	DESCRIPTION
B	C210561	2021/04/15	Vicky	$\triangle B$ X4

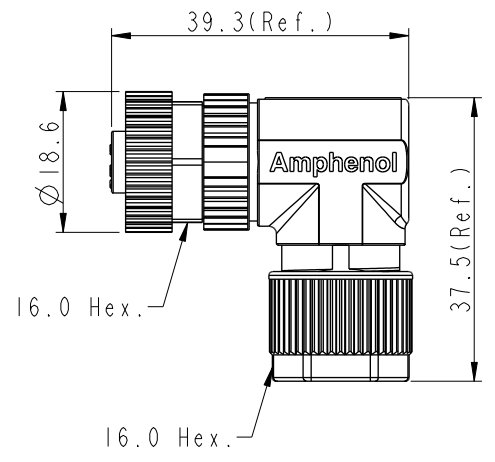
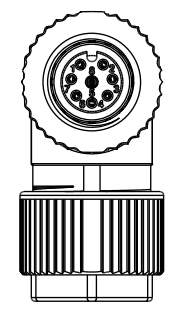
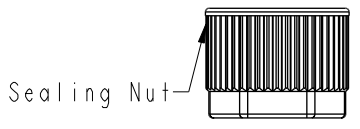
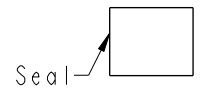
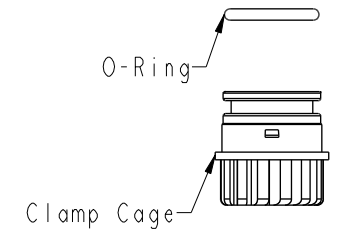
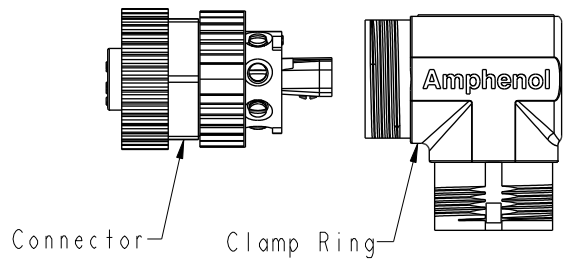

$\triangle B$
MSAS-XXBFFB-SR7001
XX: No. Of Pin

- $\triangle B$
Note:
- * RoHS Compliant
 - * $\text{\textcircled{C}}$ Important Dimension
 - * Waterproof rate: IPX7, mated
 - * Connector
 - Housing: Thermoplastic, Black
 - Pin: Copper alloy, Gold plated
 - Extension Nut: Metal
 - Nut: Metal
 - O-Ring: Rubber, Gray
 - * Clamp Ring: Metal
 - * O-Ring: Rubber, Gray
 - * Clamp Cage: Thermoplastic, Black
 - * Sealing Nut: Metal
 - * Seal: Rubber, Gray, OD: $\phi 4.0\text{mm} \sim \phi 7.0\text{mm}$
 - * One set unassembled in one pe bag

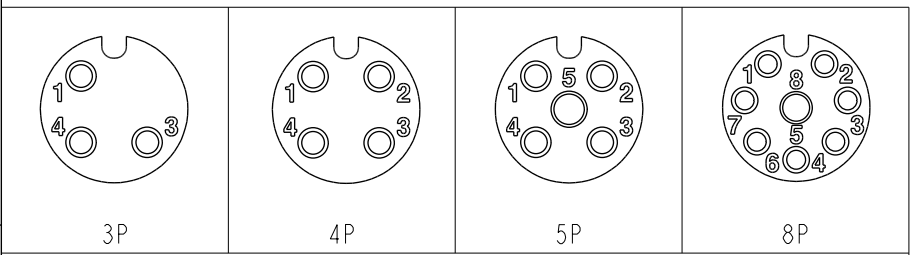

Pin Assignments Front View

UNIT: mm	$\text{\textcircled{C}}$	$\text{\textcircled{C}}$	TITLE N SEN, M12 A -SHLD, SCREW CABLE W/O SR, F, F, FI SCREW IN	$\triangle B$
TOLERANCE .X ± 0.25 .XX ± 0.1 .XXX ± 0.05 ANGLES $\pm 1^\circ$	$\triangle B$	SCALE 1:1	SIZE A4	SHEET 1 OF 1
REV. B	WC-REV. A.3	$\text{\textcircled{C}}$: Inspection item		

Amphenol LTW
安費諾亮泰企業股份有限公司

ITEM NO.	DRAWN BY Mila	DATE 2015-09-29
DWG NO. MSAS-XXBFFB-SR7001	CHECKED BY Cary	DATE 2015-09-29
CUSTOMER ALTW	APPROVED BY Jerry	DATE 2015-09-29