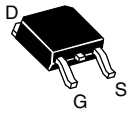
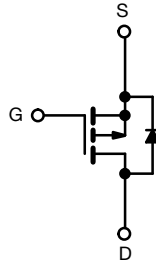
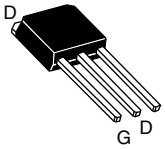

Power MOSFET

DKPAK (TO-252)

IPAK (TO-251)

P-Channel MOSFET

FEATURES

- Surface mountable (order as IRFR9020, SiHFR9020)
- Straight lead option (order as IRFU9020, SiHFU9020)
- Repetitive avalanche ratings
- Dynamic dV/dt rating
- Simple drive requirements
- Ease of paralleling
- Material categorization: for definitions of compliance please see www.vishay.com/doc?99912



RoHS
COMPLIANT
HALOGEN
FREE
Available

PRODUCT SUMMARY

V_{DS} (V)	-50	
$R_{DS(on)}$ (Ω)	$V_{GS} = -10$ V	0.28
Q_g max. (nC)	14	
Q_{gs} (nC)	6.5	
Q_{gd} (nC)	6.5	
Configuration	Single	

DESCRIPTION

The power MOSFET technology is the key to Vishay's advanced line of power MOSFET transistors. The efficient geometry and unique processing of this latest "State of the Art" design achieves: very low on-state resistance combined with high transconductance; superior reverse energy and diode recovery dV/dt.

The power MOSFET transistors also feature all of the well established advantages of MOSFET'S such as voltage control, very fast switching, ease of paralleling and temperature stability of the electrical parameters.

Surface-mount packages enhance circuit performance by reducing stray inductances and capacitance. The TO-252 surface mount package brings the advantages of power MOSFET's to high volume applications where PC board surface mounting is desirable. The surface-mount option IRFR9020, SiHFR9020 is provided on 16mm tape. The straight lead option IRFU9020, SiHFU9020 of the device is called the IPAK (TO-251).

They are well suited for applications where limited heat dissipation is required such as, computers and peripherals, telecommunication equipment, DC/DC converters, and a wide range of consumer products.

ORDERING INFORMATION

PACKAGE	DKPAK (TO-252)	DKPAK (TO-252)	DKPAK (TO-252)	IPAK (TO-251)
Lead (Pb)-free and halogen-free	SiHFR9020-GE3	SiHFR9020TR-GE3 ^a	SiHFR9020TRL-GE3 ^a	SiHFU9020-GE3
	IRFR9020TRLPBF-BE3 ^{ab}	-	-	-
Lead (Pb)-free	IRFR9020PbF	IRFR9020TRPbF ^a	IRFR9020TRLPbF ^a	IRFU9020PbF

Notes

- See device orientation
- "-BE3" denotes alternate manufacturing location



ABSOLUTE MAXIMUM RATINGS (T _C = 25 °C, unless otherwise noted)					
PARAMETER	SYMBOL		LIMIT	UNIT	
Drain-source voltage	V _{DS}		-50	V	
Gate-source voltage	V _{GS}		± 20		
Continuous drain current	V _{GS} at -10 V	T _C = 25 °C	-9.9	A	
		T _C = 100 °C	-6.3		
Pulsed drain current ^a	I _{DM}		-40		
Linear derating factor			0.33	W/°C	
Single pulse avalanche energy ^b	E _{AS}		250	mJ	
Repetitive avalanche current ^a	I _{AR}		-9.9	A	
Repetitive avalanche energy ^a	E _{AR}		4.2	mJ	
Maximum power dissipation	T _C = 25 °C		P _D	42	W
Peak diode recovery dV/dt ^c	dV/dt		5.8	V/ns	
Operating junction and storage temperature range	T _J , T _{stg}		-55 to +150	°C	
Soldering recommendations (peak temperature) ^d	for 10 s		300		

Notes

- a. Repetitive rating; pulse width limited by maximum junction temperature (see fig. 16)
- b. V_{DD} = -25 V, starting T_J = 25 °C, L = 5.1 mH, R_g = 25 Ω, peak I_L = -9.9 A
- c. I_{SD} ≤ -9.9 A, dI/dt ≤ -120 A/μs, V_{DD} ≤ 40 V, T_J ≤ 150 °C
- d. 0.063" (1.6 mm) from case
- e. When mounted on 1" square PCB (FR-4 or G-10 material)

THERMAL RESISTANCE RATINGS					
PARAMETER	SYMBOL	MIN.	TYP.	MAX.	UNIT
Maximum junction-to-ambient	R _{thJA}	-	-	110	°C/W
Case-to-sink	R _{thCS}	-	1.7	-	
Maximum junction-to-case (drain)	R _{thJC}	-	-	3.0	

SPECIFICATIONS (T _J = 25 °C, unless otherwise noted)								
PARAMETER	SYMBOL	TEST CONDITIONS			MIN.	TYP.	MAX.	UNIT
Static								
Drain-source breakdown voltage	V _{DS}	V _{GS} = 0 V, I _D = -250 μA			- 50	-	-	V
Gate-source threshold voltage	V _{GS(th)}	V _{DS} = V _{GS} , I _D = -50 μA			- 2.0	-	- 4.0	V
Gate-source leakage	I _{GSS}	V _{GS} = ±20 V			-	-	± 500	nA
Zero gate voltage drain current	I _{DSS}	V _{DS} = max. rating, V _{GS} = 0 V			-	-	250	μA
		V _{DS} = 0.8 x max. rating, V _{GS} = 0 V, T _J = 125 °C			-	-	1000	
Drain-source on-state resistance	R _{DS(on)}	V _{GS} = -10 V	I _D = 5.7 A ^b		-	0.20	0.28	Ω
Forward transconductance	g _{fs}	V _{DS} ≤ -50 V, I _{DS} = - 5.7 A			2.3	3.5	-	S
Dynamic								
Input capacitance	C _{iss}	V _{GS} = 0 V, V _{DS} = - 25 V, f = 1.0 MHz, see fig. 9			-	490	-	pF
Output capacitance	C _{oss}				-	320	-	
Reverse transfer capacitance	C _{rss}				-	70	-	
Total gate charge	Q _g	V _{GS} = -10 V	I _D = -9.7 A, V _{DS} = 0.8 x max. rating, see fig. 18 (Independent operating temperature)		-	9.4	14	nC
Gate-source charge	Q _{gs}				-	4.3	6.5	
Gate-drain charge	Q _{gd}				-	4.3	6.5	
Turn-on delay time	t _{d(on)}	V _{DD} = -25 V, I _D = -9.7 A, R _g = 18 Ω, R _D = 2.4 Ω, see fig. 17 (Independent operating temperature)			-	8.2	12	ns
Rise time	t _r				-	57	66	
Turn-off delay time	t _{d(off)}				-	12	18	
Fall time	t _f				-	25	38	
Internal drain inductance	L _D	Between lead, 6 mm (0.25") from package and center of die contact.			-	4.5	-	nH
Internal source inductance	L _S				-	7.5	-	





SPECIFICATIONS (T _J = 25 °C, unless otherwise noted)						
PARAMETER	SYMBOL	TEST CONDITIONS	MIN.	TYP.	MAX.	UNIT
Drain-source body diode characteristics						
Continuous source-drain diode current	I _S	MOSFET symbol showing the integral reverse p - n junction diode	-	-	-9.9	A
Pulsed diode forward current ^a	I _{SM}		-	-	-40	
Body diode voltage	V _{SD}	T _J = 25 °C, I _S = -9.9 A, V _{GS} = 0 V ^b	-	-	-6.3	V
Body diode reverse recovery time	t _{rr}	T _J = 25 °C, I _F = -9.7 A, dI/dt = 100 A/μs ^b	56	110	280	ns
Body diode reverse recovery charge	Q _{rr}		0.17	0.34	0.85	nC
Forward turn-on time	t _{on}	Intrinsic turn-on time is negligible (turn-on is dominated by L _S and L _D)				

Notes

- a. Repetitive rating; pulse width limited by maximum junction temperature (see fig. 16)
- b. Pulse width ≤ 300 μs; duty cycle ≤ 2 %

TYPICAL CHARACTERISTICS (25 °C, unless otherwise noted)

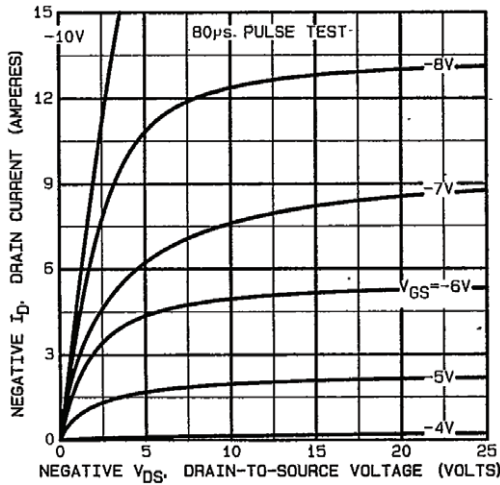

Fig. 1 - Typical Output Characteristics

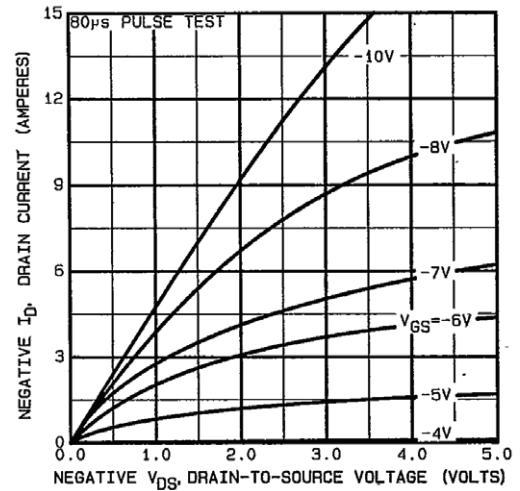

Fig. 3 - Typical Saturation Characteristics

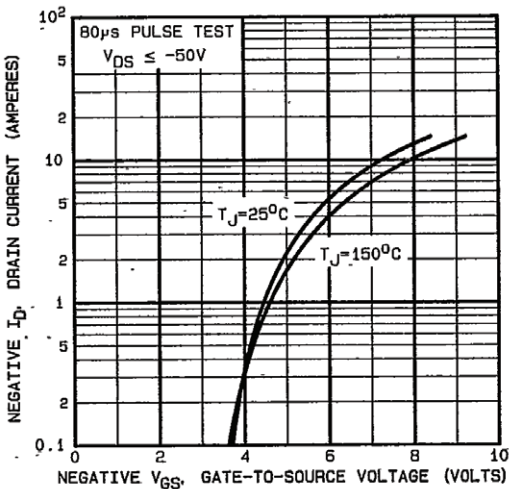

Fig. 2 - Typical Transfer Characteristics

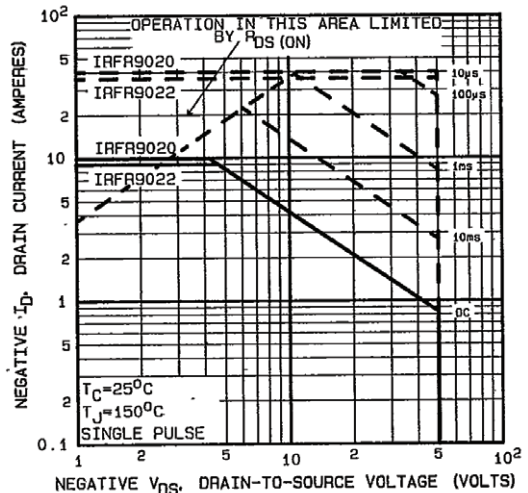

Fig. 4 - Maximum Safe Operating Area

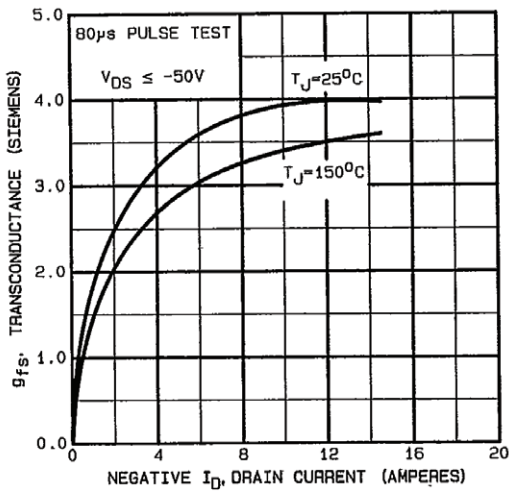

Fig. 5 - Typical Transconductance vs. Drain Current

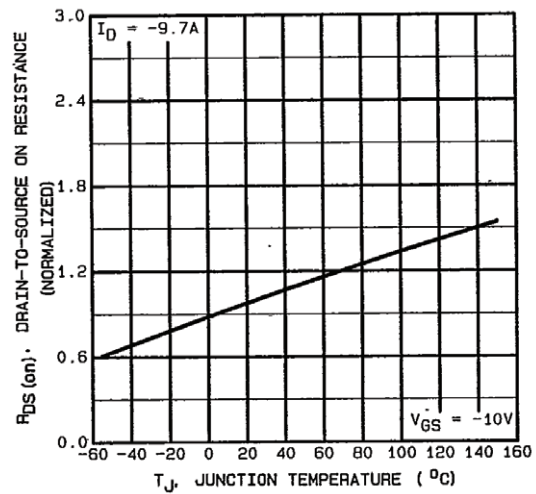

Fig. 8 - Breakdown Voltage vs. Temperature

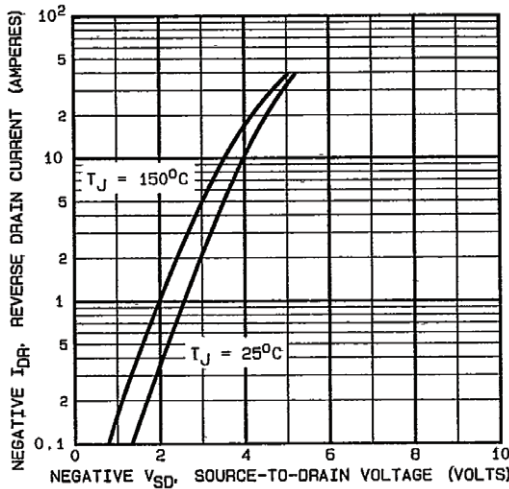

Fig. 6 - Typical Source-Drain Diode Forward Voltage

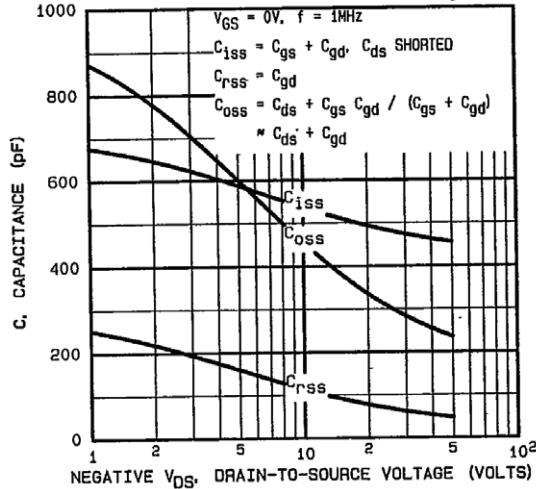

Fig. 9 - Typical Capacitance vs. Drain-to-Source Voltage

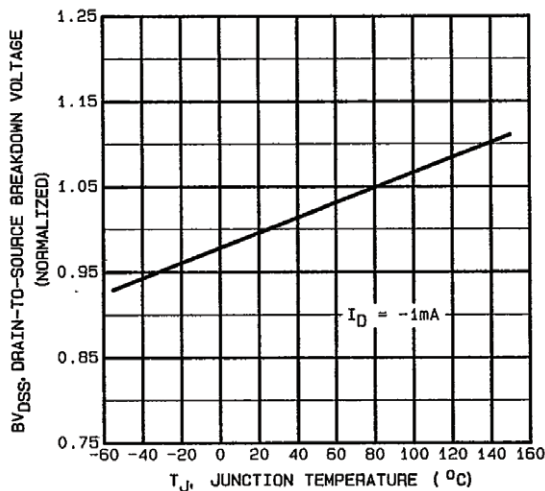

Fig. 7 - Breakdown Voltage vs. Temperature

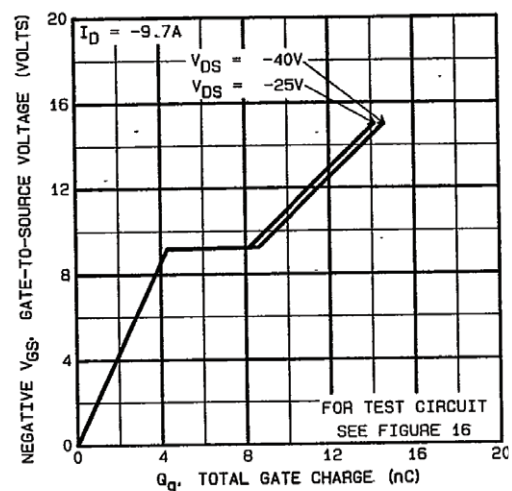

Fig. 10 - Typical Gate Charge vs. Gate-to-Source Voltage

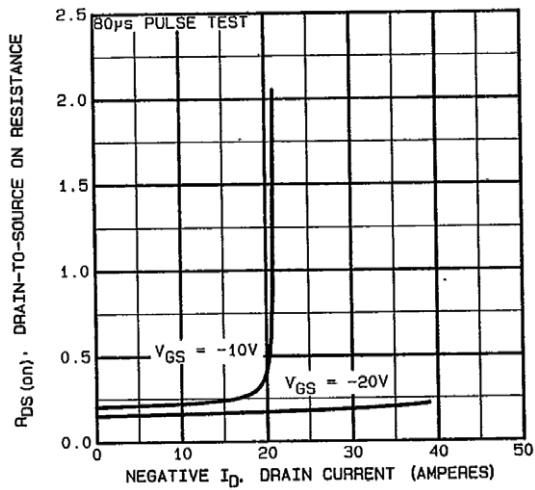

Fig. 11 - Typical On-Resistance vs. Drain Current

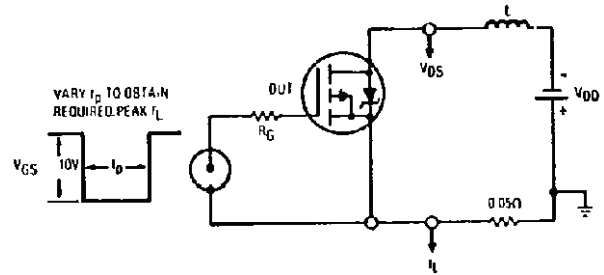

Fig. 14 - Unclamped Inductive Test Circuit

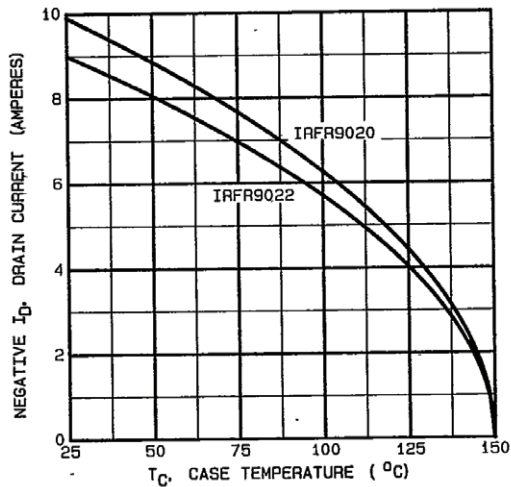

Fig. 12 - Maximum Drain Current vs. Case Temperature

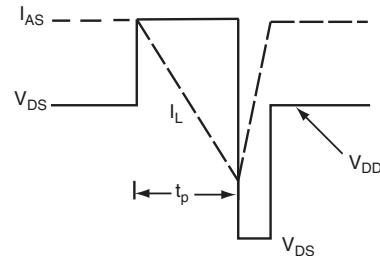

Fig. 15 - Unclamped Inductive Waveforms

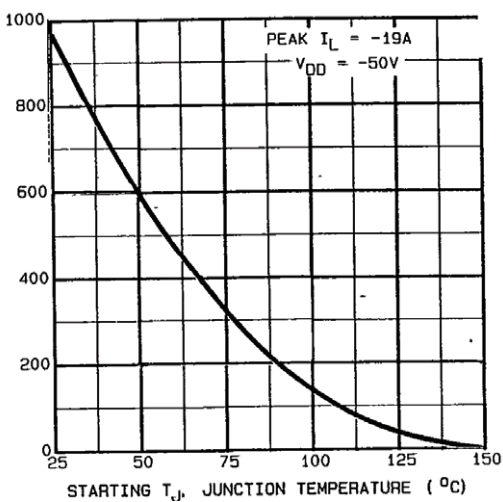

Fig. 13 - Maximum Avalanche vs. Starting Junction Temperature

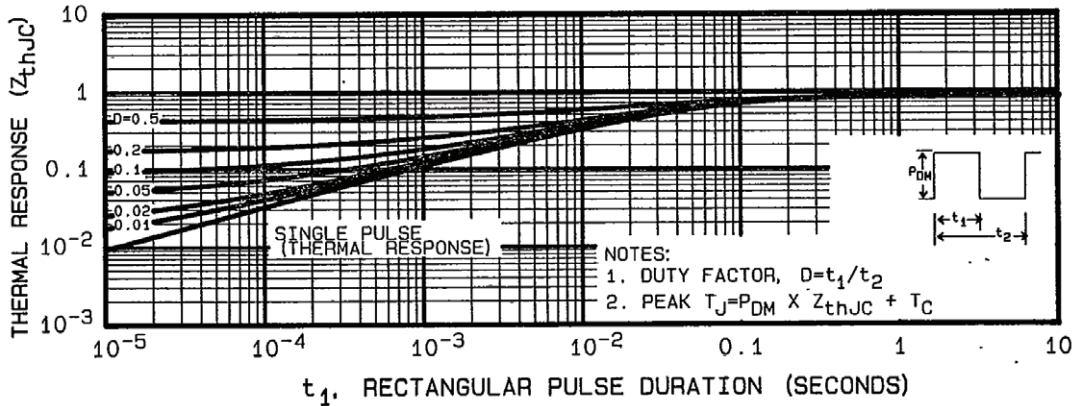

Fig. 16 - Maximum Effective Transient Thermal Impedance, Junction-to-Case vs. Pulse Duration

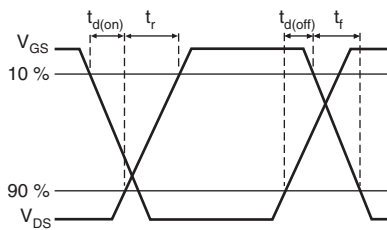

Fig. 17 - Switching Time Waveforms

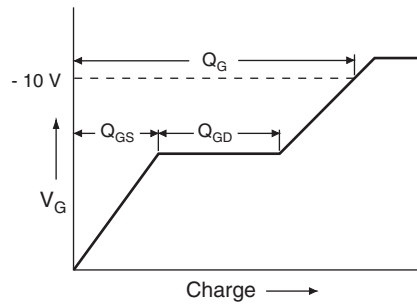

Fig. 19 - Basic Gate Charge Waveform

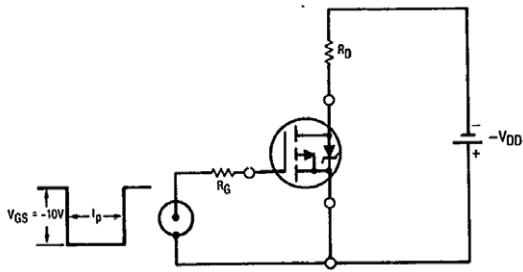

Fig. 18 - Switching Time Test Circuit

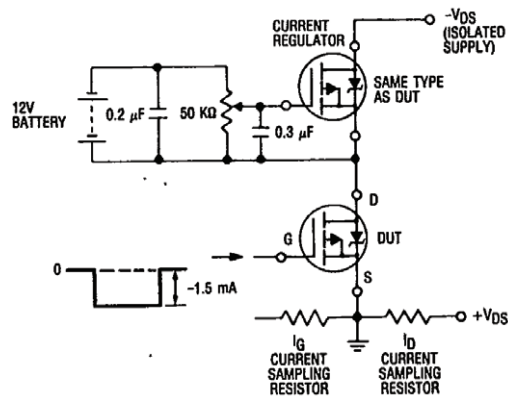
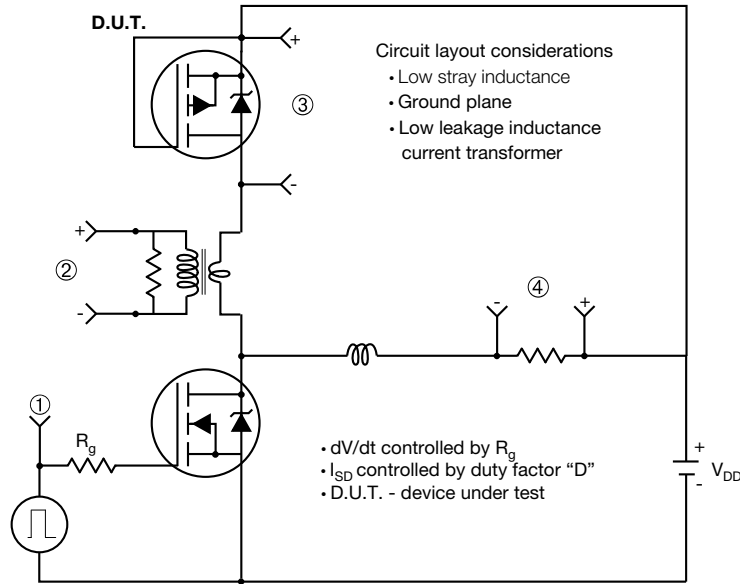
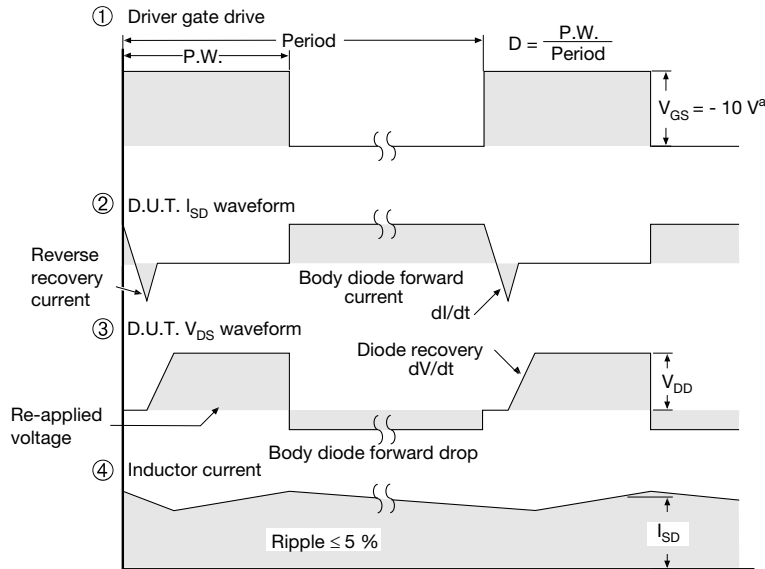

Fig. 20 - Gate Charge Test Circuit

Peak Diode Recovery dV/dt Test Circuit



Note
 • Compliment N-Channel of D.U.T. for driver



Note
 a. $V_{GS} = -5\text{ V}$ for logic level and -3 V drive devices

Fig. 21 - For P-Channel

Vishay Siliconix maintains worldwide manufacturing capability. Products may be manufactured at one of several qualified locations. Reliability data for Silicon Technology and Package Reliability represent a composite of all qualified locations. For related documents such as package/tape drawings, part marking, and reliability data, see www.vishay.com/ppg?90350.



TO-252AA Case Outline

VERSION 1: FACILITY CODE = Y

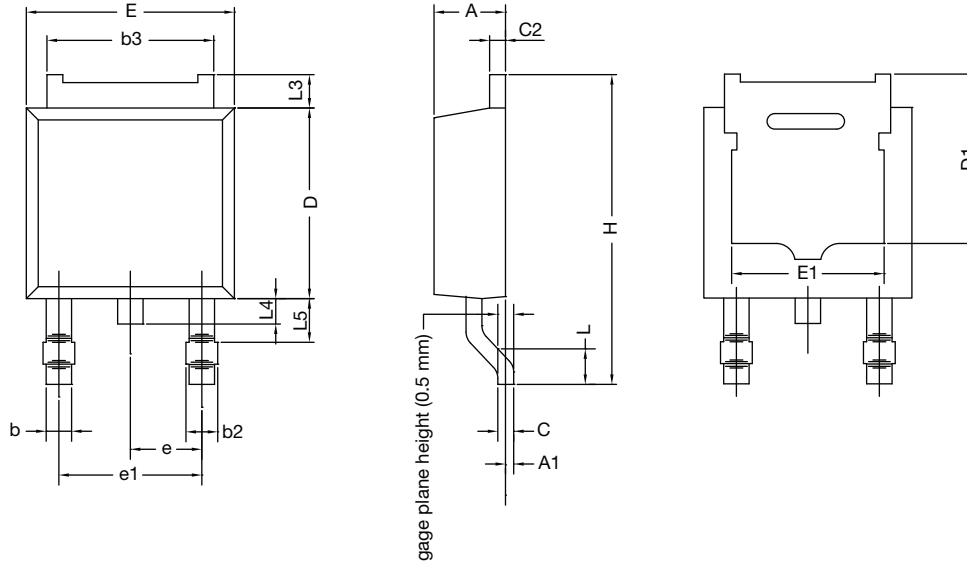

MILLIMETERS		
DIM.	MIN.	MAX.
A	2.18	2.38
A1	-	0.127
b	0.64	0.88
b2	0.76	1.14
b3	4.95	5.46
C	0.46	0.61
C2	0.46	0.89
D	5.97	6.22
D1	4.10	-
E	6.35	6.73
E1	4.32	-
H	9.40	10.41
e	2.28 BSC	
e1	4.56 BSC	
L	1.40	1.78
L3	0.89	1.27
L4	-	1.02
L5	1.01	1.52

Note

- Dimension L3 is for reference only



VERSION 2: FACILITY CODE = N



DIM.	MILLIMETERS	
	MIN.	MAX.
A	2.18	2.39
A1	-	0.13
b	0.65	0.89
b1	0.64	0.79
b2	0.76	1.13
b3	4.95	5.46
c	0.46	0.61
c1	0.41	0.56
c2	0.46	0.60
D	5.97	6.22
D1	5.21	-
E	6.35	6.73
E1	4.32	-
e	2.29 BSC	
H	9.94	10.34

DIM.	MILLIMETERS	
	MIN.	MAX.
L	1.50	1.78
L1	2.74 ref.	
L2	0.51 BSC	
L3	0.89	1.27
L4	-	1.02
L5	1.14	1.49
L6	0.65	0.85
θ	0°	10°
θ1	0°	15°
θ2	25°	35°

Notes

- Dimensioning and tolerance confirm to ASME Y14.5M-1994
- All dimensions are in millimeters. Angles are in degrees
- Heat sink side flash is max. 0.8 mm
- Radius on terminal is optional

ECN: E19-0649-Rev. Q, 16-Dec-2019
 DWG: 5347

Case Outline for TO-251AA (High Voltage)

OPTION 1:



DIM.	MILLIMETERS		INCHES	
	MIN.	MAX.	MIN.	MAX.
A	2.18	2.39	0.086	0.094
A1	0.89	1.14	0.035	0.045
b	0.64	0.89	0.025	0.035
b1	0.65	0.79	0.026	0.031
b2	0.76	1.14	0.030	0.045
b3	0.76	1.04	0.030	0.041
b4	4.95	5.46	0.195	0.215
c	0.46	0.61	0.018	0.024
c1	0.41	0.56	0.016	0.022
c2	0.46	0.86	0.018	0.034
D	5.97	6.22	0.235	0.245

DIM.	MILLIMETERS		INCHES	
	MIN.	MAX.	MIN.	MAX.
D1	5.21	-	0.205	-
E	6.35	6.73	0.250	0.265
E1	4.32	-	0.170	-
e	2.29 BSC		2.29 BSC	
L	8.89	9.65	0.350	0.380
L1	1.91	2.29	0.075	0.090
L2	0.89	1.27	0.035	0.050
L3	1.14	1.52	0.045	0.060
θ1	0°	15°	0°	15°
θ2	25°	35°	25°	35°

ECN: E21-0682-Rev. C, 27-Dec-2021
 DWG: 5968

Notes

- Dimensioning and tolerancing per ASME Y14.5M-1994
- Dimension are shown in inches and millimeters
- Dimension D and E do not include mold flash. Mold flash shall not exceed 0.13 mm (0.005") per side. These dimensions are measured at the outermost extremes of the plastic body
- Thermal pad contour optional with dimensions b4, L2, E1 and D1
- Lead dimension uncontrolled in L3
- Dimension b1, b3 and c1 apply to base metal only
- Outline conforms to JEDEC® outline TO-251AA



OPTION 2: FACILITY CODE = N



DIM.	MIN.	NOM.	MAX.
A	2.180	2.285	2.390
A1	0.890	1.015	1.140
b	0.640	0.765	0.890
b1	0.640	0.715	0.790
b2	0.760	0.950	1.140
b3	0.760	0.900	1.040
b4	4.950	5.205	5.460
c	0.460	-	0.610
c1	0.410	-	0.560
c2	0.460	-	0.610
D	5.970	6.095	6.220
D1	4.300	-	-

DIM.	MIN.	NOM.	MAX.
D2	5.380	-	-
E	6.350	6.540	6.730
E1	4.32	-	-
e	2.29 BSC		
L	8.890	9.270	9.650
L1	1.910	2.100	2.290
L2	0.890	1.080	1.270
L3	1.140	1.330	1.520
L4	1.300	1.400	1.500
θ_1	0°	7.5°	15°
θ_2	4°	-	-

ECN: E21-0682-Rev. C, 27-Dec-2021
DWG: 5968

Notes

- Dimensioning and tolerancing per ASME Y14.5M-1994
- All dimension are in millimeters, angles are in degrees
- Heat sink side flash is max. 0.8 mm

RECOMMENDED MINIMUM PADS FOR DPAK (TO-252)



Recommended Minimum Pads
Dimensions in Inches/(mm)

[Return to Index](#)



Disclaimer

ALL PRODUCT, PRODUCT SPECIFICATIONS AND DATA ARE SUBJECT TO CHANGE WITHOUT NOTICE TO IMPROVE RELIABILITY, FUNCTION OR DESIGN OR OTHERWISE.

Vishay Intertechnology, Inc., its affiliates, agents, and employees, and all persons acting on its or their behalf (collectively, "Vishay"), disclaim any and all liability for any errors, inaccuracies or incompleteness contained in any datasheet or in any other disclosure relating to any product.

Vishay makes no warranty, representation or guarantee regarding the suitability of the products for any particular purpose or the continuing production of any product. To the maximum extent permitted by applicable law, Vishay disclaims (i) any and all liability arising out of the application or use of any product, (ii) any and all liability, including without limitation special, consequential or incidental damages, and (iii) any and all implied warranties, including warranties of fitness for particular purpose, non-infringement and merchantability.

Statements regarding the suitability of products for certain types of applications are based on Vishay's knowledge of typical requirements that are often placed on Vishay products in generic applications. Such statements are not binding statements about the suitability of products for a particular application. It is the customer's responsibility to validate that a particular product with the properties described in the product specification is suitable for use in a particular application. Parameters provided in datasheets and / or specifications may vary in different applications and performance may vary over time. All operating parameters, including typical parameters, must be validated for each customer application by the customer's technical experts. Product specifications do not expand or otherwise modify Vishay's terms and conditions of purchase, including but not limited to the warranty expressed therein.

Hyperlinks included in this datasheet may direct users to third-party websites. These links are provided as a convenience and for informational purposes only. Inclusion of these hyperlinks does not constitute an endorsement or an approval by Vishay of any of the products, services or opinions of the corporation, organization or individual associated with the third-party website. Vishay disclaims any and all liability and bears no responsibility for the accuracy, legality or content of the third-party website or for that of subsequent links.

Except as expressly indicated in writing, Vishay products are not designed for use in medical, life-saving, or life-sustaining applications or for any other application in which the failure of the Vishay product could result in personal injury or death. Customers using or selling Vishay products not expressly indicated for use in such applications do so at their own risk. Please contact authorized Vishay personnel to obtain written terms and conditions regarding products designed for such applications.

No license, express or implied, by estoppel or otherwise, to any intellectual property rights is granted by this document or by any conduct of Vishay. Product names and markings noted herein may be trademarks of their respective owners.