





ABSOLUTE MAXIMUM RATINGS (T <sub>amb</sub> = 25 °C, unless otherwise specified)				
PARAMETER	TEST CONDITION	SYMBOL	VALUE	UNIT
<b>INPUT</b>				
Reverse voltage		V <sub>R</sub>	6	V
Forward current		I <sub>F</sub>	60	mA
Forward surge current	t <sub>p</sub> ≤ 10 μs	I <sub>FSM</sub>	2.5	A
Power dissipation	at 25 °C	P <sub>diss</sub>	70	mW
<b>OUTPUT</b>				
Collector emitter voltage		V <sub>CEO</sub>	80	V
Emitter collector voltage		V <sub>ECO</sub>	7	V
Collector current	t <sub>p</sub> ≤ 1 ms	I <sub>C</sub>	50	mA
			100	mA
Output power dissipation	at 25 °C	P <sub>diss</sub>	150	mW
<b>COUPLER</b>				
Isolation test voltage (RMS)	t = 1 min	V <sub>ISO</sub>	5300	V <sub>RMS</sub>
Total power dissipation		P <sub>tot</sub>	200	mW
Operation temperature		T <sub>amb</sub>	- 55 to + 110	°C
Storage temperature range		T <sub>stg</sub>	- 55 to + 150	°C
Junction temperature		T <sub>j</sub>	125	°C
Soldering temperature <sup>(1)</sup>	2 mm from case, ≤ 10 s	T <sub>slid</sub>	260	°C

**Notes**

- Stresses in excess of the absolute maximum ratings can cause permanent damage to the device. Functional operation of the device is not implied at these or any other conditions in excess of those given in the operational sections of this document. Exposure to absolute maximum ratings for extended periods of the time can adversely affect reliability.
- Refer to wave profile for soldering conditions for through hole devices (DIP).

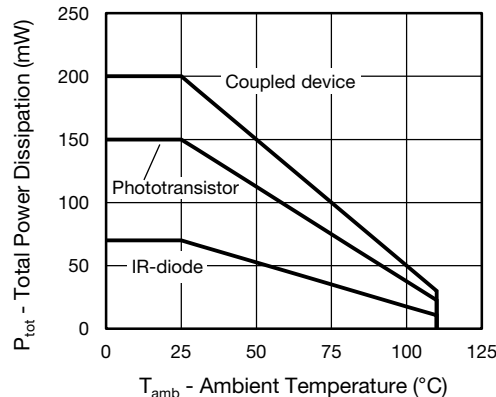

Fig. 1 - Total Power Dissipation vs. Ambient Temperature

ELECTRICAL CHARACTERISTICS (T <sub>amb</sub> = 25 °C, unless otherwise specified)						
PARAMETER	TEST CONDITION	SYMBOL	MIN.	TYP.	MAX.	UNIT
<b>INPUT</b>						
Forward voltage	I <sub>F</sub> = 60 mA	V <sub>F</sub>		1.1	1.6	V
Reverse current	V <sub>R</sub> = 6 V	I <sub>R</sub>		0.01	10	μA
Junction capacitance	V <sub>R</sub> = 0 V, f = 1 MHz	C <sub>j</sub>		9		pF
<b>OUTPUT</b>						
Collector emitter leakage current	V <sub>CE</sub> = 10 V	I <sub>CEO</sub>		0.3	100	nA
Collector emitter capacitance	V <sub>CE</sub> = 5 V, f = 1 MHz	C <sub>CCE</sub>		2.8		pF
Collector emitter breakdown voltage	I <sub>C</sub> = 100 μA	BV <sub>CEO</sub>	80			V
Emitter collector breakdown voltage	I <sub>E</sub> = 10 μA	BV <sub>ECO</sub>	7			V
<b>COUPLER</b>						
Collector emitter saturation voltage	I <sub>F</sub> = 10 mA, I <sub>C</sub> = 2.5 mA	V <sub>CEsat</sub>		0.25	0.4	V
Coupling capacitance	f = 1 MHz	C <sub>IO</sub>		0.3		pF
Cut-off frequency	I <sub>F</sub> = 10 mA, V <sub>CC</sub> = 5 V, R <sub>L</sub> = 100 Ω	f <sub>ctr</sub>		110		kHz

**Note**

- Minimum and maximum values are testing requirements. Typical values are characteristics of the device and are the result of engineering evaluation. Typical values are for information only and are not part of the testing requirements.

<b>CURRENT TRANSFER RATIO</b> ( $T_{amb} = 25\text{ }^{\circ}\text{C}$ , unless otherwise specified)							
PARAMETER	TEST CONDITION	PART	SYMBOL	MIN.	TYP.	MAX.	UNIT
$I_C/I_F$	$I_F = 5\text{ mA}$ , $V_{CE} = 5\text{ V}$	VO617C-1	CTR	40		80	%
		VO617C-2	CTR	63		125	%
		VO617C-3	CTR	100		200	%
		VO617C-4	CTR	160		320	%

<b>SWITCHING CHARACTERISTICS</b> ( $T_{amb} = 25\text{ }^{\circ}\text{C}$ , unless otherwise specified)							
PARAMETER	TEST CONDITION	SYMBOL	MIN.	TYP.	MAX.	UNIT	
<b>NON-SATURATED</b>							
Rise time	$I_C = 2\text{ mA}$ , $V_{CC} = 5\text{ V}$ , $R_L = 100\text{ }\Omega$	$t_r$		3		$\mu\text{s}$	
Fall time		$t_f$		3		$\mu\text{s}$	
Turn-on time		$t_{on}$		6		$\mu\text{s}$	
Turn-off time		$t_{off}$		4		$\mu\text{s}$	
<b>SATURATED</b>							
Rise time	$I_F = 1.6\text{ mA}$ , $V_{CC} = 5\text{ V}$ , $R_L = 1.9\text{ k}\Omega$	$t_r$		7		$\mu\text{s}$	
Fall time		$t_f$		12		$\mu\text{s}$	
Turn-on time		$t_{on}$		9		$\mu\text{s}$	
Turn-off time		$t_{off}$		15		$\mu\text{s}$	

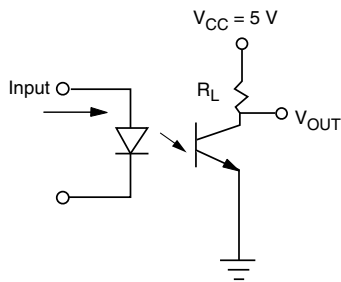

Fig. 2 - Test Circuit

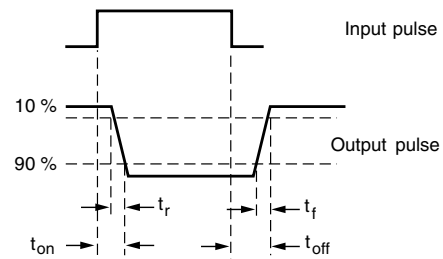

Fig. 3 - Test Circuit and Waveforms

<b>SAFETY AND INSULATION RATINGS</b>			
PARAMETER		SYMBOL	UNIT
<b>MAXIMUM SAFETY RATINGS</b>			
Output safety power		$P_{SO}$	mW
Input safety current		$I_{si}$	mW
Safety temperature		$T_S$	$^{\circ}\text{C}$
Comparative tracking index		CTI	175
<b>INSULATION RATED PARAMETERS</b>			
Maximum withstanding isolation voltage		$V_{ISO}$	$V_{RMS}$
Maximum transient isolation voltage		$V_{IOTM}$	$V_{peak}$
Maximum repetitive peak isolation voltage		$V_{IORM}$	$V_{peak}$
		$V_{IORM}^{(1)}$	$V_{peak}$
Insulation resistance	$T_{amb} = 25\text{ }^{\circ}\text{C}$ , $V_{DC} = 500\text{ V}$	$R_{IO}$	$\Omega$
Isolation resistance	$T_{amb} = 100\text{ }^{\circ}\text{C}$ , $V_{DC} = 500\text{ V}$	$R_{IO}$	$\Omega$
Climatic classification (according to IEC 68 part 1)			55/110/21
Environment (pollution degree in accordance to DIN VDE 0109)			2
Internal and external creepage	Standard DIP-4		$\geq 7$ mm
	400 mil DIP-4, SMD-4 option 9		$\geq 8$ mm
Clearance	Standard DIP-4		$\geq 7$ mm
	400 mil DIP-4, SMD-4 option 9		$\geq 8$ mm
Insulation thickness			0.4 mm

**Notes**

- As per DIN EN 60747-5-5, § 7.4.3.8.2), this optocoupler is suitable for “safe electrical insulation” only within the safety ratings. Compliance with the safety ratings shall be ensured by means of protective circuits.

(1) Only for option 6.

**TYPICAL CHARACTERISTICS** ( $T_{amb} = 25\text{ }^{\circ}\text{C}$ , unless otherwise specified)

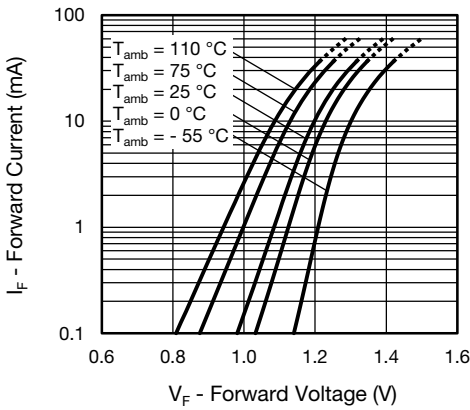

Fig. 4 - Forward Voltage vs. Forward Current

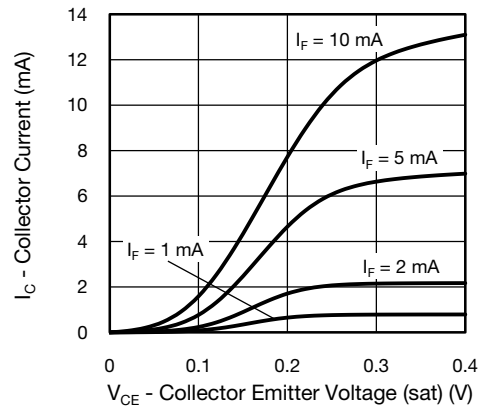

Fig. 7 - Collector Current vs. Collector Emitter Voltage (saturated)

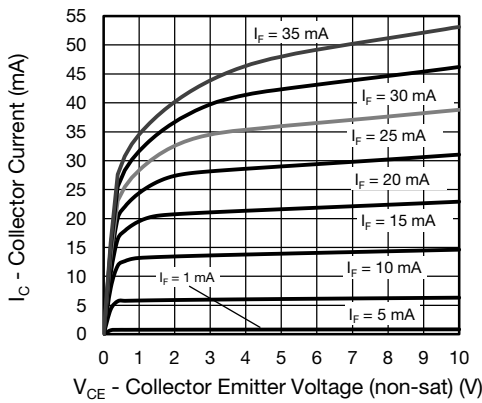

Fig. 5 - Collector Current vs. Collector Emitter Voltage (NS)

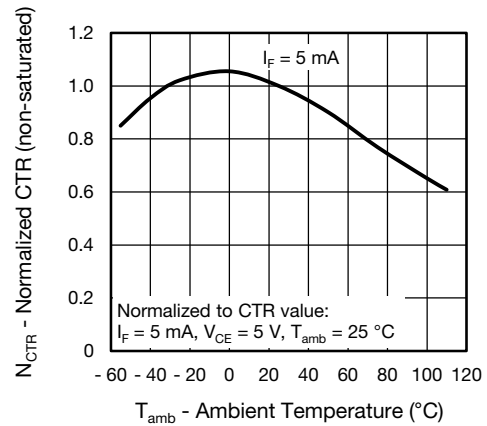

Fig. 8 - Normalized Current Transfer Ratio (non-saturated) vs. Ambient Temperature

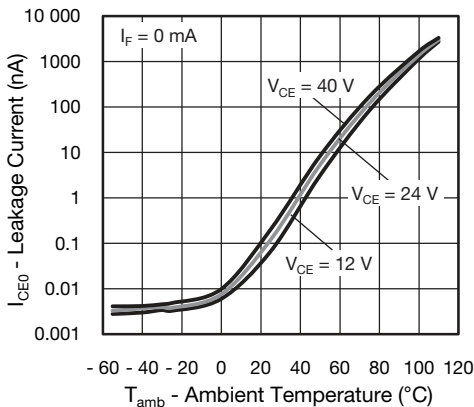

Fig. 6 - Leakage Current vs. Ambient Temperature

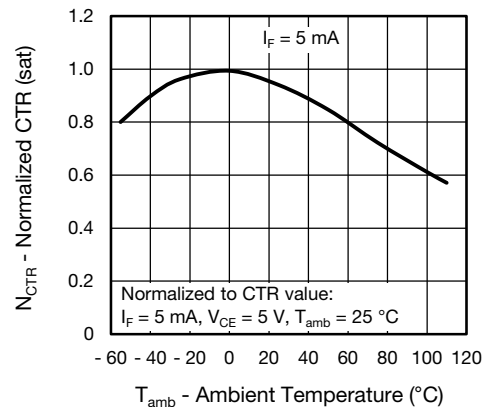

Fig. 9 - Normalized Current Transfer Ratio (saturated) vs. Ambient Temperature

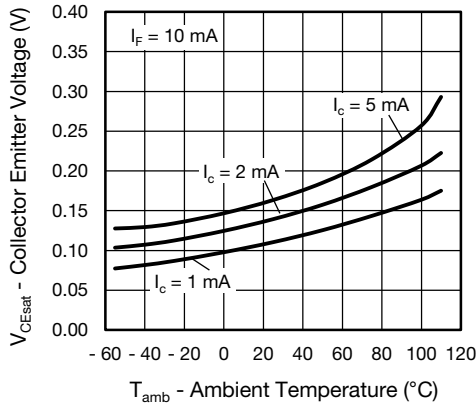

Fig. 10 - Collector Emitter Voltage vs. Ambient Temperature (saturated)

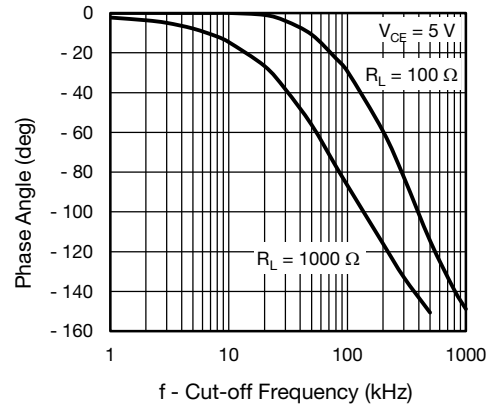

Fig. 13 -  $F_{CTR}$  vs. Phase Angle

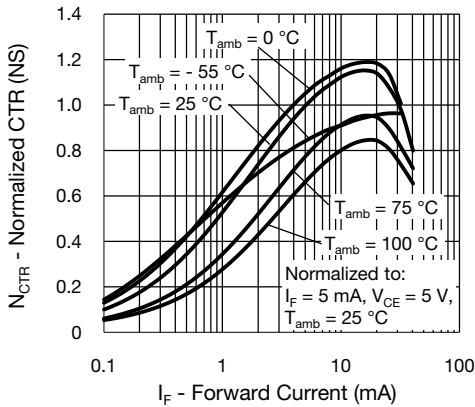

Fig. 11 - Normalized CTR (non-saturated) vs. Forward Current

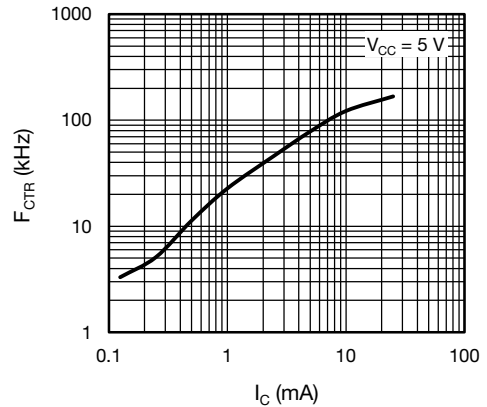

Fig. 14 -  $F_{CTR}$  vs. Collector Current

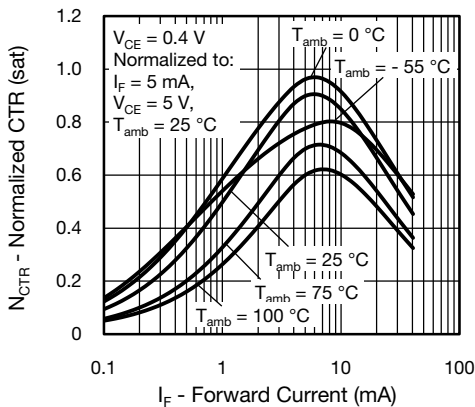

Fig. 12 - Normalized CTR (saturated) vs. Forward Current

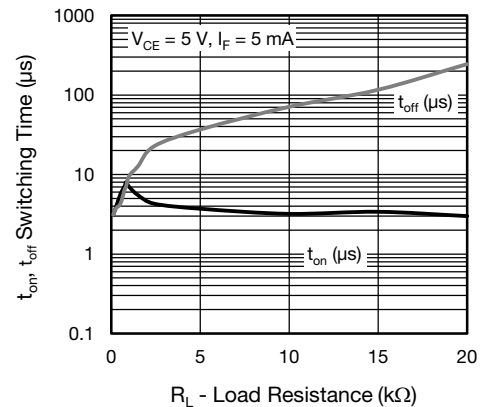
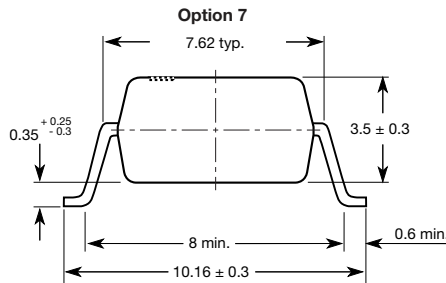
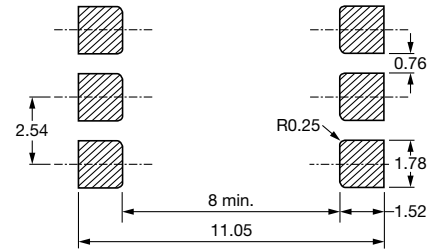
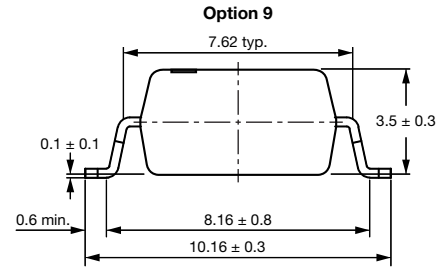
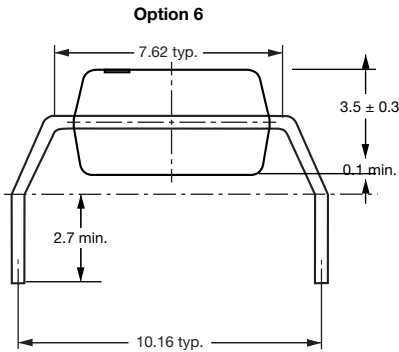
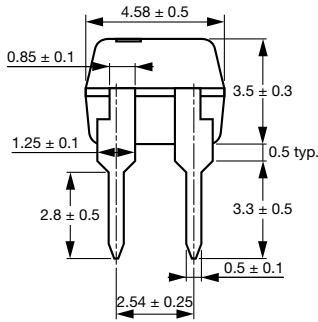
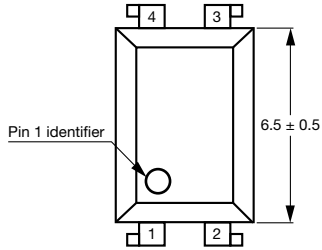

Fig. 15 - Switching Time vs. Load Resistance



PACKAGE DIMENSIONS in millimeters



i178027-25

PACKAGE MARKING (example of VO617C-3X016)

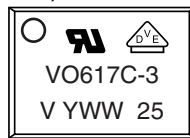

Note

- Option information is not marked.

**PACKING INFORMATION**

DEVICE PER TUBE			
TYPE	UNITS/TUBE	TUBES/BOX	UNITS/BOX
DIP-4	100	40	4000

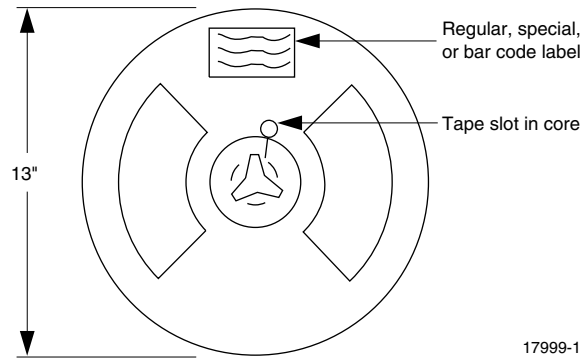

Fig. 16 - Tape and Reel Shipping Medium

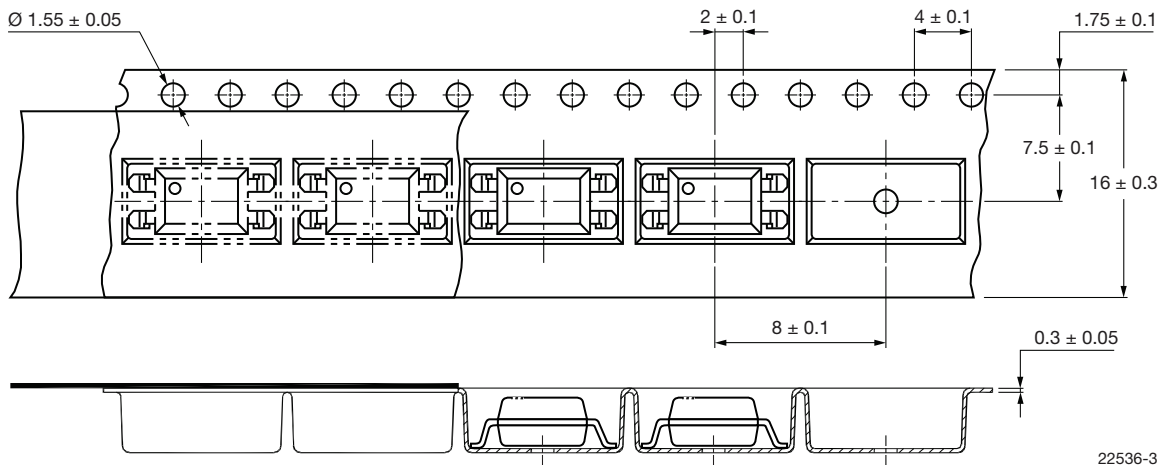

Fig. 17 - Tape Packing for Option 7 and 9 (1000 units per reel)

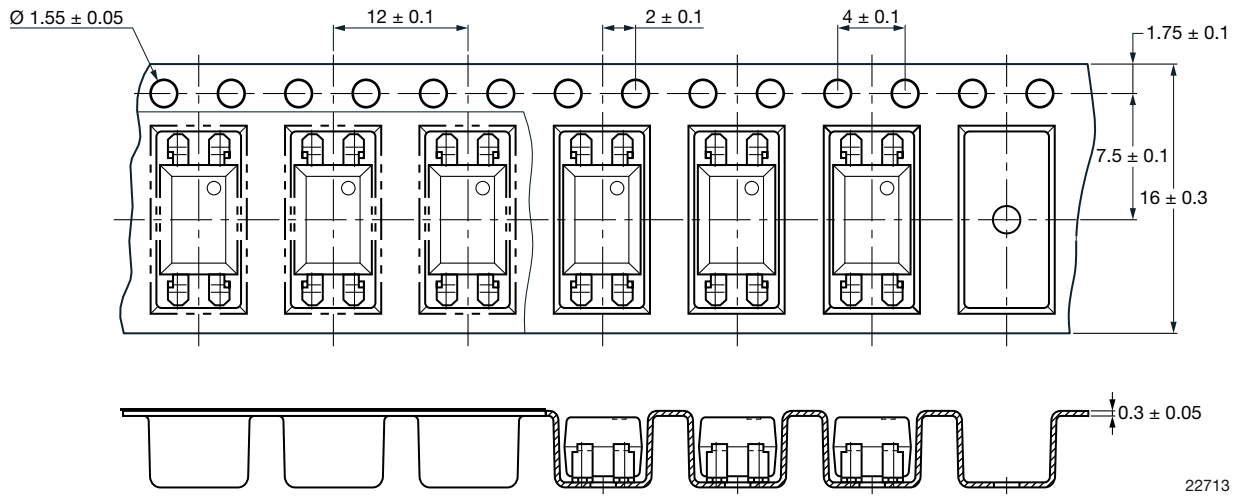

Fig. 18 - Tape Packing for Option 7 and 9, T1 rotation (2000 units per reel)





## Disclaimer

ALL PRODUCT, PRODUCT SPECIFICATIONS AND DATA ARE SUBJECT TO CHANGE WITHOUT NOTICE TO IMPROVE RELIABILITY, FUNCTION OR DESIGN OR OTHERWISE.

Vishay Intertechnology, Inc., its affiliates, agents, and employees, and all persons acting on its or their behalf (collectively, "Vishay"), disclaim any and all liability for any errors, inaccuracies or incompleteness contained in any datasheet or in any other disclosure relating to any product.

Vishay makes no warranty, representation or guarantee regarding the suitability of the products for any particular purpose or the continuing production of any product. To the maximum extent permitted by applicable law, Vishay disclaims (i) any and all liability arising out of the application or use of any product, (ii) any and all liability, including without limitation special, consequential or incidental damages, and (iii) any and all implied warranties, including warranties of fitness for particular purpose, non-infringement and merchantability.

Statements regarding the suitability of products for certain types of applications are based on Vishay's knowledge of typical requirements that are often placed on Vishay products in generic applications. Such statements are not binding statements about the suitability of products for a particular application. It is the customer's responsibility to validate that a particular product with the properties described in the product specification is suitable for use in a particular application. Parameters provided in datasheets and / or specifications may vary in different applications and performance may vary over time. All operating parameters, including typical parameters, must be validated for each customer application by the customer's technical experts. Product specifications do not expand or otherwise modify Vishay's terms and conditions of purchase, including but not limited to the warranty expressed therein.

Hyperlinks included in this datasheet may direct users to third-party websites. These links are provided as a convenience and for informational purposes only. Inclusion of these hyperlinks does not constitute an endorsement or an approval by Vishay of any of the products, services or opinions of the corporation, organization or individual associated with the third-party website. Vishay disclaims any and all liability and bears no responsibility for the accuracy, legality or content of the third-party website or for that of subsequent links.

Except as expressly indicated in writing, Vishay products are not designed for use in medical, life-saving, or life-sustaining applications or for any other application in which the failure of the Vishay product could result in personal injury or death. Customers using or selling Vishay products not expressly indicated for use in such applications do so at their own risk. Please contact authorized Vishay personnel to obtain written terms and conditions regarding products designed for such applications.

No license, express or implied, by estoppel or otherwise, to any intellectual property rights is granted by this document or by any conduct of Vishay. Product names and markings noted herein may be trademarks of their respective owners.