

**TLC225x, TLC225xA**  
**Advanced LinCMOS™ RAIL-TO-RAIL**  
**VERY LOW-POWER OPERATIONAL AMPLIFIERS**

SLOS176D – FEBRUARY 1997 – REVISED MARCH 2001

- **Output Swing Includes Both Supply Rails**
- **Low Noise . . . 19 nV/√Hz Typ at f = 1 kHz**
- **Low Input Bias Current . . . 1 pA Typ**
- **Fully Specified for Both Single-Supply and Split-Supply Operation**
- **Very Low Power . . . 35 μA Per Channel Typ**
- **Common-Mode Input Voltage Range Includes Negative Rail**
- **Low Input Offset Voltage**  
850 μV Max at T<sub>A</sub> = 25°C (TLC225xA)
- **Macromodel Included**
- **Performance Upgrades for the TS27L2/L4 and TLC27L2/L4**
- **Available in Q-Temp Automotive HighRel Automotive Applications Configuration Control / Print Support Qualification to Automotive Standards**

**description**

The TLC2252 and TLC2254 are dual and quadruple operational amplifiers from Texas Instruments. Both devices exhibit rail-to-rail output performance for increased dynamic range in single- or split-supply applications. The TLC225x family consumes only 35 μA of supply current per channel. This micropower operation makes them good choices for battery-powered applications. The noise performance has been dramatically improved over previous generations of CMOS amplifiers. Looking at Figure 1, the TLC225x has a noise level of 19 nV/√Hz at 1kHz; four times lower than competitive micropower solutions.

The TLC225x amplifiers, exhibiting high input impedance and low noise, are excellent for small-signal conditioning for high-impedance sources, such as piezoelectric transducers. Because of the micropower dissipation levels, these devices work well in hand-held monitoring and remote-sensing applications. In addition, the rail-to-rail output feature with single or split supplies makes this family a great choice when interfacing with analog-to-digital converters (ADCs). For precision applications, the TLC225xA family is available and has a maximum input offset voltage of 850 μV. This family is fully characterized at 5 V and ±5 V.

The TLC2252/4 also makes great upgrades to the TLC27L2/L4 or TS27L2/L4 in standard designs. They offer increased output dynamic range, lower noise voltage, and lower input offset voltage. This enhanced feature set allows them to be used in a wider range of applications. For applications that require higher output drive and wider input voltage ranges, see the TLV2432 and TLV2442 devices. If the design requires single amplifiers, please see the TLV2211/21/31 family. These devices are single rail-to-rail operational amplifiers in the SOT-23 package. Their small size and low power consumption, make them ideal for high density, battery-powered equipment.

**EQUIVALENT INPUT NOISE VOLTAGE  
VS  
FREQUENCY**

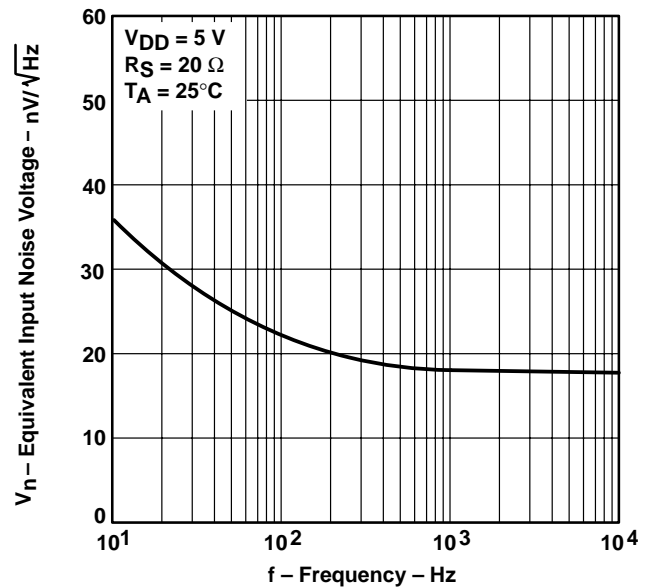

**Figure 1**



Please be aware that an important notice concerning availability, standard warranty, and use in critical applications of Texas Instruments semiconductor products and disclaimers thereto appears at the end of this data sheet.

Advanced LinCMOS is a trademark of Texas Instruments.

PRODUCTION DATA information is current as of publication date. Products conform to specifications per the terms of Texas Instruments standard warranty. Production processing does not necessarily include testing of all parameters.



POST OFFICE BOX 655303 • DALLAS, TEXAS 75265

Copyright © 2001, Texas Instruments Incorporated  
 On products compliant to MIL-PRF-38535, all parameters are tested unless otherwise noted. On all other products, production processing does not necessarily include testing of all parameters.

**TLC225x, TLC225xA**  
**Advanced LinCMOS™ RAIL-TO-RAIL**  
**VERY LOW-POWER OPERATIONAL AMPLIFIERS**

SLOS176D – FEBRUARY 1997 – REVISED MARCH 2001

**TLC2252 AVAILABLE OPTIONS**

T <sub>A</sub>	V <sub>IO</sub> max AT 25°C	PACKAGED DEVICES					
		SMALL OUTLINE† (D)	CHIP CARRIER (FK)	CERAMIC DIP (JG)	PLASTIC DIP (P)	TSSOP‡ (PW)	CERAMIC FLATPACK (U)
0°C to 70°C	1500 μV	TLC2252CD	—	—	TLC2252CP	TLC2252CPW	—
–40°C to 125°C	850 μV 1500 μV	TLC2252AID TLC2252ID	— —	— —	TLC2252AIP TLC2252IP	TLC2252AIPW —	— —
–40°C to 125°C	850 μV 1500 μV	TLC2252AQD TLC2252QD	— —	— —	— —	— —	— —
–55°C to 125°C	850 μV 1500 μV	— —	TLC2252AMFK TLC2252MFK	TLC2252AMJG TLC2252MJG	— —	— —	TLC2252AMU TLC2252MU

† The D packages are available taped and reeled. Add R suffix to device type (e.g., TLC2262CDR).

‡ The PW package is available only left-ended taped and reeled.

§ Chip forms are tested at 25°C only.

**TLC2254 AVAILABLE OPTIONS**

T <sub>A</sub>	V <sub>IO</sub> max AT 25°C	PACKAGED DEVICES					
		SMALL OUTLINE† (D)	CHIP CARRIER (FK)	CERAMIC DIP (J)	PLASTIC DIP (N)	TSSOP‡ (PW)	CERAMIC FLATPACK (W)
0°C to 70°C	1500 μV	TLC2254CD	—	—	TLC2254CN	TLC2254CPW	—
–40°C to 125°C	850 μV 1500 μV	TLC2254AID TLC2254ID	— —	— —	TLC2254AIN TLC2254IN	TLC2254AIPW —	— —
–40°C to 125°C	850 μV 1500 μV	TLC2254AQD TLC2254QD	— —	— —	— —	— —	— —
–55°C to 125°C	850 μV 1500 μV	— —	TLC2254AMFK TLC2254MFK	TLC2254AMJ TLC2254MJ	— —	— —	TLC2254AMW TLC2254MW

† The D packages are available taped and reeled. Add R suffix to the device type (e.g., TLC2254CDR).

‡ The PW package is available only left-end taped and reeled. Chips are tested at 25°C.

§ Chip forms are tested at 25°C only.



**TLC225x, TLC225xA**  
**Advanced LinCMOS™ RAIL-TO-RAIL**  
**VERY LOW-POWER OPERATIONAL AMPLIFIERS**

SLOS176D – FEBRUARY 1997 – REVISED MARCH 2001

**TLC2252C, TLC2252AC**  
**TLC2252I, TLC2252AI**  
**TLC2252Q, TLC2252AQ**  
**D, P, OR PW PACKAGE**  
**(TOP VIEW)**

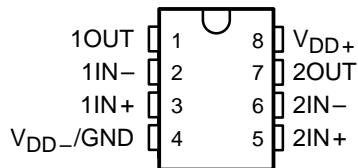

**TLC2252M, TLC2252AM ... FK PACKAGE**  
**(TOP VIEW)**

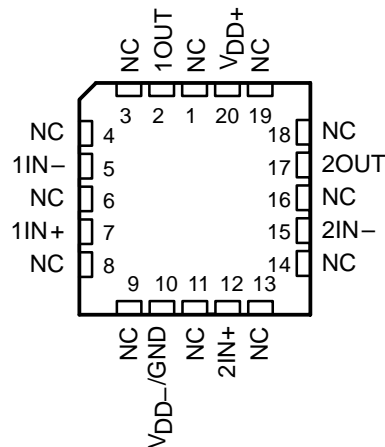

**TLC2252M, TLC2252AM ... JG PACKAGE**  
**(TOP VIEW)**

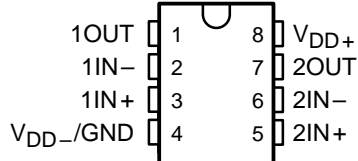

**TLC2262M, TLC2252AM ... U PACKAGE**  
**(TOP VIEW)**

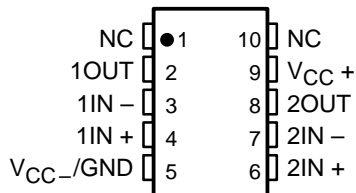

**TLC2254C, TLC2254AC**  
**TLC2254I, TLC2254AI**  
**TLC2254Q, TLC2254AQ**  
**D, N, OR PW PACKAGE**  
**(TOP VIEW)**



**TLC2254M, TLC2254AM**  
**J OR W PACKAGE**  
**(TOP VIEW)**



**TLC2254M, TLC2254AM**  
**FK PACKAGE**  
**(TOP VIEW)**

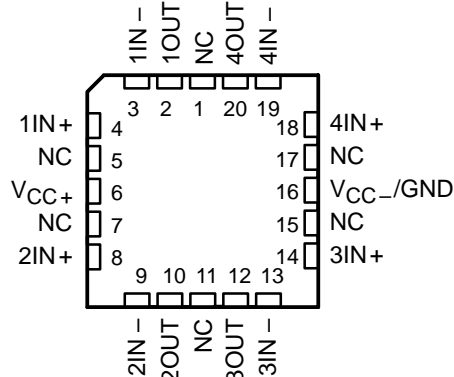

NC – No internal connection

**TLC225x, TLC225xA**  
**Advanced LinCMOS™ RAIL-TO-RAIL**  
**VERY LOW-POWER OPERATIONAL AMPLIFIERS**

SLOS176D – FEBRUARY 1997 – REVISED MARCH 2001

equivalent schematic (each amplifier)

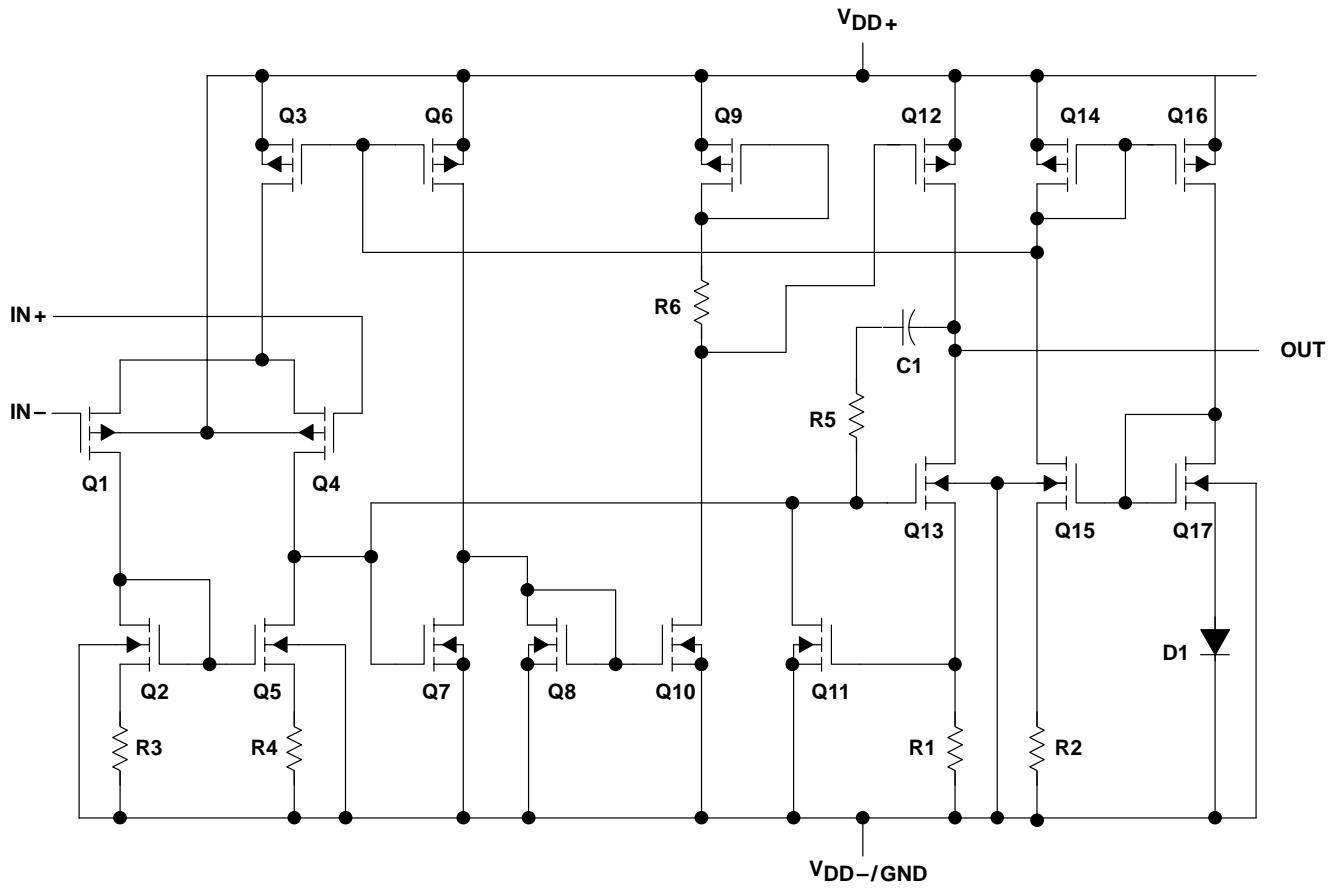

ACTUAL DEVICE COMPONENT COUNT†		
COMPONENT	TLC2252	TLC2254
Transistors	38	76
Resistors	30	56
Diodes	9	18
Capacitors	3	6

† Includes both amplifiers and all ESD, bias, and trim circuitry

**TLC225x, TLC225xA**  
**Advanced LinCMOS™ RAIL-TO-RAIL**  
**VERY LOW-POWER OPERATIONAL AMPLIFIERS**

SLOS176D – FEBRUARY 1997 – REVISED MARCH 2001

**absolute maximum ratings over operating free-air temperature range (unless otherwise noted)†**

Supply voltage, $V_{DD+}$ (see Note 1)	8 V
Supply voltage, $V_{DD-}$ (see Note 1)	–8 V
Differential input voltage, $V_{ID}$ (see Note 2)	±16 V
Input voltage, $V_I$ (any input, see Note 1)	±8 V
Input current, $I_I$ (each input)	±5 mA
Output current, $I_O$	±50 mA
Total current into $V_{DD+}$	±50 mA
Total current out of $V_{DD-}$	±50 mA
Duration of short-circuit current at (or below) 25°C (see Note 3)	unlimited
Continuous total dissipation	See Dissipation Rating Table
Operating free-air temperature range, $T_A$ : C suffix	0°C to 70°C
I suffix	–40°C to 125°C
Q suffix	–40°C to 125°C
M suffix	–55°C to 125°C
Storage temperature range, $T_{stg}$	–65°C to 150°C
Lead temperature 1,6 mm (1/16 inch) from case for 10 seconds	260°C

† Stresses beyond those listed under “absolute maximum ratings” may cause permanent damage to the device. These are stress ratings only, and functional operation of the device at these or any other conditions beyond those indicated under “recommended operating conditions” is not implied. Exposure to absolute-maximum-rated conditions for extended periods may affect device reliability.

- NOTES: 1. All voltage values, except differential voltages, are with respect to the midpoint between  $V_{DD+}$  and  $V_{DD-}$ .  
2. Differential voltages are at  $IN+$  with respect to  $IN-$ . Excessive current flows when input is brought below  $V_{DD-} - 0.3$  V.  
3. The output may be shorted to either supply. Temperature and/or supply voltages must be limited to ensure that the maximum dissipation rating is not exceeded.

**DISSIPATION RATING TABLE**

PACKAGE	$T_A \leq 25^\circ\text{C}$ POWER RATING	DERATING FACTOR ABOVE $T_A = 25^\circ\text{C}$	$T_A = 70^\circ\text{C}$ POWER RATING	$T_A = 85^\circ\text{C}$ POWER RATING	$T_A = 125^\circ\text{C}$ POWER RATING
D–8	724 mW	5.8 mW/°C	464 mW	377 mW	144 mW
D–14	950 mW	7.6 mW/°C	608 mW	450 mW	190 mW
FK	1375 mW	11.0 mW/°C	880 mW	715 mW	275 mW
J	1375 mW	11.0 mW/°C	880 mW	715 mW	275 mW
JG	1050 mW	8.4 mW/°C	672 mW	546 mW	275 mW
N	1150 mW	9.2 mW/°C	736 mW	736 mW	—
P	1000 mW	8.0 mW/°C	640 mW	520 mW	—
PW–8	525 mW	4.2 mW/°C	336 mW	273 mW	—
PW–14	700 mW	5.6 mW/°C	448 mW	448 mW	—
U	700 mW	5.5 mW/°C	246 mW	330 mW	150 mW
W	700 mW	5.5 mW/°C	246 mW	330 mW	150 mW

**recommended operating conditions**

	C SUFFIX		I SUFFIX		Q SUFFIX		M SUFFIX		UNIT
	MIN	MAX	MIN	MAX	MIN	MAX	MIN	MAX	
Supply voltage, $V_{DD\pm}$	±2.2	±8	±2.2	±8	±2.2	±8	±2.2	±8	V
Input voltage range, $V_I$	$V_{DD-}$	$V_{DD+} - 1.5$	$V_{DD-}$	$V_{DD+} - 1.5$	$V_{DD-}$	$V_{DD+} - 1.5$	$V_{DD-}$	$V_{DD+} - 1.5$	V
Common-mode input voltage, $V_{IC}$	$V_{DD-}$	$V_{DD+} - 1.5$	$V_{DD-}$	$V_{DD+} - 1.5$	$V_{DD-}$	$V_{DD+} - 1.5$	$V_{DD-}$	$V_{DD+} - 1.5$	V
Operating free-air temperature, $T_A$	0	70	–40	125	–40	125	–55	125	°C



**TLC225x, TLC225xA**  
**Advanced LinCMOS™ RAIL-TO-RAIL**  
**VERY LOW-POWER OPERATIONAL AMPLIFIERS**

SLOS176D – FEBRUARY 1997 – REVISED MARCH 2001

**electrical characteristics at specified free-air temperature,  $V_{DD} = 5\text{ V}$  (unless otherwise noted)**

PARAMETER	TEST CONDITIONS	$T_A$ †	TLC2252C			UNIT
			MIN	TYP	MAX	
$V_{IO}$ Input offset voltage	$V_{IC} = 0,$ $V_O = 0,$ $V_{DD} \pm = \pm 2.5\text{ V},$ $R_S = 50\ \Omega$	25°C	200	1500	$\mu\text{V}$	
		Full range	1750			
$\alpha_{VIO}$ Temperature coefficient of input offset voltage		25°C to 70°C	0.5		$\mu\text{V}/^\circ\text{C}$	
Input offset voltage long-term drift (see Note 4)		25°C	0.003		$\mu\text{V}/\text{mo}$	
$I_{IO}$ Input offset current		25°C	0.5	60	$\text{pA}$	
		Full range	100			
$I_{IB}$ Input bias current		25°C	1	60	$\text{pA}$	
		Full range	100			
$V_{ICR}$ Common-mode input voltage range	$R_S = 50\ \Omega,$ $ V_{IO}  \leq 5\text{ mV}$	25°C	0 to 4	-0.3 to 4.2	$\text{V}$	
		Full range	0 to 3.5			
$V_{OH}$ High-level output voltage	$I_{OH} = -20\ \mu\text{A}$	25°C	4.98		$\text{V}$	
	$I_{OH} = -75\ \mu\text{A}$	25°C	4.9	4.94		
	Full range	4.8				
	$I_{OH} = -150\ \mu\text{A}$	25°C	4.8	4.88		
$V_{OL}$ Low-level output voltage	$V_{IC} = 2.5\text{ V},$ $I_{OL} = 50\ \mu\text{A}$	25°C	0.01		$\text{V}$	
	$V_{IC} = 2.5\text{ V},$ $I_{OL} = 500\ \mu\text{A}$	25°C	0.09	0.15		
	Full range	0.15				
	$V_{IC} = 2.5\text{ V},$ $I_{OL} = 1\text{ mA}$	25°C	0.2	0.3		
	Full range	0.3				
	$V_{IC} = 2.5\text{ V},$ $I_{OL} = 4\text{ mA}$	25°C	0.7	1		
	Full range	1.2				
	$A_{VD}$ Large-signal differential voltage amplification	$V_{IC} = 2.5\text{ V},$ $V_O = 1\text{ V to }4\text{ V}$	$R_L = 100\text{ k}\Omega$ ‡	25°C		100
Full range			10			
$R_L = 1\text{ M}\Omega$ ‡			25°C	1700		
$r_{id}$ Differential input resistance		25°C	$10^{12}$		$\Omega$	
$r_{ic}$ Common-mode input resistance		25°C	$10^{12}$		$\Omega$	
$c_{ic}$ Common-mode input capacitance	$f = 10\text{ kHz},$ P package	25°C	8		$\text{pF}$	
$z_o$ Closed-loop output impedance	$f = 25\text{ kHz},$ $A_V = 10$	25°C	200		$\Omega$	
CMRR Common-mode rejection ratio	$V_{IC} = 0\text{ to }2.7\text{ V},$ $V_O = 2.5\text{ V},$ $R_S = 50\ \Omega$	25°C	70	83	$\text{dB}$	
		Full range	70			
$k_{SVR}$ Supply-voltage rejection ratio ( $\Delta V_{DD}/\Delta V_{IO}$ )	$V_{DD} = 4.4\text{ V to }16\text{ V},$ $V_{IC} = V_{DD}/2,$ No load	25°C	80	95	$\text{dB}$	
		Full range	80			
$I_{DD}$ Supply current	$V_O = 2.5\text{ V},$ No load	25°C	70	125	$\mu\text{A}$	
		Full range	150			

† Full range is 0°C to 70°C.

‡ Referenced to 2.5 V

NOTE 4: Typical values are based on the input offset voltage shift observed through 500 hours of operating life test at  $T_A = 150^\circ\text{C}$  extrapolated to  $T_A = 25^\circ\text{C}$  using the Arrhenius equation and assuming an activation energy of 0.96 eV.



**TLC225x, TLC225xA**  
**Advanced LinCMOS™ RAIL-TO-RAIL**  
**VERY LOW-POWER OPERATIONAL AMPLIFIERS**

SLOS176D – FEBRUARY 1997 – REVISED MARCH 2001

**operating characteristics at specified free-air temperature,  $V_{DD} = 5\text{ V}$**

PARAMETER		TEST CONDITIONS		$T_A$ †	TLC2252C			UNIT
					MIN	TYP	MAX	
SR	Slew rate at unity gain	$V_O = 1.5\text{ V to }3.5\text{ V}, R_L = 100\text{ k}\Omega^\ddagger,$ $C_L = 100\text{ pF}^\ddagger$		25°C	0.07	0.12	$\text{V}/\mu\text{s}$	
				Full range	0.05			
$V_n$	Equivalent input noise voltage	f = 10 Hz		25°C	36		$\text{nV}/\sqrt{\text{Hz}}$	
		f = 1 kHz		25°C	19			
$V_{N(PP)}$	Peak-to-peak equivalent input noise voltage	f = 0.1 Hz to 1 Hz		25°C	0.7		$\mu\text{V}$	
		f = 0.1 Hz to 10 Hz		25°C	1.1			
$I_n$	Equivalent input noise current			25°C	0.6		$\text{fA}/\sqrt{\text{Hz}}$	
THD + N	Total harmonic distortion plus noise	$V_O = 0.5\text{ V to }2.5\text{ V},$ f = 10 kHz, $R_L = 50\text{ k}\Omega^\ddagger$		25°C	$A_V = 1$			
					$A_V = 10$			
Gain-bandwidth product		f = 10 kHz, $C_L = 100\text{ pF}^\ddagger$		25°C	$R_L = 50\text{ k}\Omega^\ddagger$		MHz	
					0.2			
$B_{OM}$	Maximum output-swing bandwidth	$V_{O(PP)} = 2\text{ V},$ $R_L = 50\text{ k}\Omega^\ddagger$		25°C	$A_V = 1,$ $C_L = 100\text{ pF}^\ddagger$		kHz	
					30			
$\phi_m$	Phase margin at unity gain	$R_L = 50\text{ k}\Omega^\ddagger,$ $C_L = 100\text{ pF}^\ddagger$		25°C	63°			
Gain margin				25°C	15		dB	

† Full range is 0°C to 70°C.

‡ Referenced to 2.5 V

**TLC225x, TLC225xA**  
**Advanced LinCMOS™ RAIL-TO-RAIL**  
**VERY LOW-POWER OPERATIONAL AMPLIFIERS**

SLOS176D – FEBRUARY 1997 – REVISED MARCH 2001

**electrical characteristics at specified free-air temperature,  $V_{DD\pm} = \pm 5\text{ V}$  (unless otherwise specified)**

PARAMETER	TEST CONDITIONS	T <sub>A</sub> †	TLC2252C			UNIT
			MIN	TYP	MAX	
V <sub>IO</sub> Input offset voltage	V <sub>IC</sub> = 0, V <sub>O</sub> = 0, R <sub>S</sub> = 50 Ω	25°C	200	1500		μV
		Full range		1750		
αV <sub>IO</sub> Temperature coefficient of input offset voltage		25°C to 70°C	0.5			μV/°C
Input offset voltage long-term drift (see Note 4)		25°C	0.003			μV/mo
I <sub>IO</sub> Input offset current		25°C	0.5	60		pA
		Full range		100		
I <sub>IB</sub> Input bias current		25°C	1	60		pA
		Full range		100		
V <sub>ICR</sub> Common-mode input voltage range	V <sub>IO</sub>   ≤ 5 mV, R <sub>S</sub> = 50 Ω	25°C	-5 to 4	-5.3 to 4.2		V
		Full range	-5 to 3.5			
V <sub>OM+</sub> Maximum positive peak output voltage	I <sub>O</sub> = -20 μA	25°C	4.98		V	
	I <sub>O</sub> = -100 μA	25°C	4.9	4.93		
		Full range	4.7			
	I <sub>O</sub> = -200 μA	25°C	4.8	4.86		
V <sub>OM-</sub> Maximum negative peak output voltage	V <sub>IC</sub> = 0, I <sub>O</sub> = 50 μA	25°C	-4.99		V	
		25°C	-4.85	-4.91		
	V <sub>IC</sub> = 0, I <sub>O</sub> = 500 μA	Full range	-4.85			
		25°C	-4.7	-4.8		
	V <sub>IC</sub> = 0, I <sub>O</sub> = 1 mA	Full range	-4.7			
		25°C	-4	-4.3		
	V <sub>IC</sub> = 0, I <sub>O</sub> = 4 mA	Full range	-3.8			
		25°C	45	650		V/mV
A <sub>VD</sub> Large-signal differential voltage amplification	V <sub>O</sub> = ±4 V	R <sub>L</sub> = 100 kΩ	Full range	10		
		R <sub>L</sub> = 1 MΩ	25°C	3000		
r <sub>id</sub> Differential input resistance		25°C	10 <sup>12</sup>	Ω		
r <sub>ic</sub> Common-mode input resistance		25°C	10 <sup>12</sup>	Ω		
c <sub>ic</sub> Common-mode input capacitance	f = 10 kHz, P package	25°C	8	pF		
z <sub>o</sub> Closed-loop output impedance	f = 25 kHz, A <sub>V</sub> = 10	25°C	190	Ω		
CMRR Common-mode rejection ratio	V <sub>IC</sub> = -5 V to 2.7 V, V <sub>O</sub> = 0, R <sub>S</sub> = 50 Ω	25°C	75	88	dB	
		Full range	75			
k <sub>SVR</sub> Supply-voltage rejection ratio (ΔV <sub>DD±</sub> /ΔV <sub>IO</sub> )	V <sub>DD±</sub> = 2.2 V to ±8 V, V <sub>IC</sub> = 0, No load	25°C	80	95	dB	
		Full range	80			
I <sub>DD</sub> Supply current	V <sub>O</sub> = 0, No load	25°C	80	125	μA	
		Full range		150		

† Full range is 0°C to 70°C.

NOTE 4: Typical values are based on the input offset voltage shift observed through 500 hours of operating life test at T<sub>A</sub> = 150°C extrapolated to T<sub>A</sub> = 25°C using the Arrhenius equation and assuming an activation energy of 0.96 eV.





**TLC225x, TLC225xA**  
**Advanced LinCMOS™ RAIL-TO-RAIL**  
**VERY LOW-POWER OPERATIONAL AMPLIFIERS**

SLOS176D – FEBRUARY 1997 – REVISED MARCH 2001

**operating characteristics at specified free-air temperature,  $V_{DD\pm} = \pm 5\text{ V}$**

PARAMETER	TEST CONDITIONS	$T_A$ †	TLC2252C			UNIT
			MIN	TYP	MAX	
SR Slew rate at unity gain	$V_O = \pm 1.9\text{ V}$ , $R_L = 100\text{ k}\Omega$ , $C_L = 100\text{ pF}$	25°C	0.07	0.12		V/ $\mu\text{s}$
		Full range	0.05			
$V_n$ Equivalent input noise voltage	$f = 10\text{ Hz}$	25°C	38		nV/ $\sqrt{\text{Hz}}$	
	$f = 1\text{ kHz}$	25°C	19			
$V_{N(PP)}$ Peak-to-peak equivalent input noise voltage	$f = 0.1\text{ Hz to }1\text{ Hz}$	25°C	0.8		$\mu\text{V}$	
	$f = 0.1\text{ Hz to }10\text{ Hz}$	25°C	1.1			
$I_n$ Equivalent input noise current		25°C	0.6		fA/ $\sqrt{\text{Hz}}$	
THD + N Total harmonic distortion pulse duration	$V_O = \pm 2.3\text{ V}$ , $f = 10\text{ kHz}$ , $R_L = 50\text{ k}\Omega$	$A_V = 1$	0.2%			
		$A_V = 10$	1%			
Gain-bandwidth product	$f = 10\text{ kHz}$ , $R_L = 50\text{ k}\Omega$ , $C_L = 100\text{ pF}$	25°C	0.21		MHz	
$B_{OM}$ Maximum output-swing bandwidth	$V_{O(PP)} = 4.6\text{ V}$ , $R_L = 50\text{ k}\Omega$ , $A_V = 1$ , $C_L = 100\text{ pF}$	25°C	14		kHz	
$\phi_m$ Phase margin at unity gain	$R_L = 50\text{ k}\Omega$ , $C_L = 100\text{ pF}$	25°C	63°			
Gain margin		25°C	15		dB	

† Full range is 0°C to 70°C.

**TLC225x, TLC225xA**  
**Advanced LinCMOS™ RAIL-TO-RAIL**  
**VERY LOW-POWER OPERATIONAL AMPLIFIERS**

SLOS176D – FEBRUARY 1997 – REVISED MARCH 2001

**electrical characteristics at specified free-air temperature,  $V_{DD} = 5\text{ V}$  (unless otherwise noted)**

PARAMETER	TEST CONDITIONS	$T_A$ †	TLC2254C			UNIT
			MIN	TYP	MAX	
$V_{IO}$ Input offset voltage	$V_{IC} = 0,$ $V_O = 0,$ $V_{DD\pm} = \pm 2.5\text{ V},$ $R_S = 50\ \Omega$	25°C	200	1500		$\mu\text{V}$
		Full range		1750		
$\alpha_{V_{IO}}$ Temperature coefficient of input offset voltage		25°C to 70°C	0.5			$\mu\text{V}/^\circ\text{C}$
Input offset voltage long-term drift (see Note 4)		25°C	0.003			$\mu\text{V}/\text{mo}$
$I_{IO}$ Input offset current		25°C	0.5	60		$\text{pA}$
		Full range		100		
$I_{IB}$ Input bias current		25°C	1	60		$\text{pA}$
		Full range		100		
$V_{ICR}$ Common-mode input voltage range	$R_S = 50\ \Omega,$ $ V_{IO}  \leq 5\text{ mV}$	25°C	0 to 4	-0.3 to 4.2		V
		Full range	0 to 3.5			
$V_{OH}$ High-level output voltage	$I_{OH} = -20\ \mu\text{A}$ $I_{OH} = -75\ \mu\text{A}$ $I_{OH} = -150\ \mu\text{A}$	25°C		4.98		V
		25°C	4.9	4.94		
		Full range	4.8			
$V_{OL}$ Low-level output voltage	$V_{IC} = 2.5\text{ V},$ $I_{OL} = 50\ \mu\text{A}$ $I_{OL} = 500\ \mu\text{A}$ $I_{OL} = 1\text{ mA}$ $I_{OL} = 4\text{ mA}$	25°C	0.01			V
		25°C	0.09	0.15		
		Full range		0.15		
		25°C	0.2	0.3		
		Full range		0.3		
		25°C	0.7	1		
$A_{VD}$ Large-signal differential voltage amplification	$V_{IC} = 2.5\text{ V},$ $V_O = 1\text{ V to }4\text{ V}$ $R_L = 100\text{ k}\Omega\ddagger$ $R_L = 1\text{ M}\Omega\ddagger$	25°C	100	350		V/mV
		Full range	10			
		25°C		1700		
$r_{i(d)}$ Differential input resistance		25°C		$10^{12}$		$\Omega$
$r_{i(c)}$ Common-mode input resistance		25°C		$10^{12}$		$\Omega$
$c_{i(c)}$ Common-mode input capacitance	$f = 10\text{ kHz},$ N package	25°C		8		pF
$z_o$ Closed-loop output impedance	$f = 25\text{ kHz},$ $A_V = 10$	25°C		200		$\Omega$
CMRR Common-mode rejection ratio	$V_{IC} = 0\text{ to }2.7\text{ V},$ $V_O = 2.5\text{ V},$ $R_S = 50\ \Omega$	25°C	70	83		dB
		Full range	70			
$k_{SVR}$ Supply-voltage rejection ratio ( $\Delta V_{DD}/\Delta V_{IO}$ )	$V_{DD} = 4.4\text{ V to }16\text{ V},$ $V_{IC} = V_{DD}/2,$ No load	25°C	80	95		dB
		Full range	80			
$I_{DD}$ Supply current (four amplifiers)	$V_O = 2.5\text{ V},$ No load	25°C	140	250		$\mu\text{A}$
		Full range		300		

† Full range is 0°C to 70°C.

‡ Referenced to 2.5 V

NOTE 4: Typical values are based on the input offset voltage shift observed through 500 hours of operating life test at  $T_A = 150^\circ\text{C}$  extrapolated to  $T_A = 25^\circ\text{C}$  using the Arrhenius equation and assuming an activation energy of 0.96 eV.



**TLC225x, TLC225xA**  
**Advanced LinCMOS™ RAIL-TO-RAIL**  
**VERY LOW-POWER OPERATIONAL AMPLIFIERS**

SLOS176D – FEBRUARY 1997 – REVISED MARCH 2001

**operating characteristics at specified free-air temperature,  $V_{DD} = 5\text{ V}$**

PARAMETER		TEST CONDITIONS		$T_A$ †	TLC2254C			UNIT
					MIN	TYP	MAX	
SR	Slew rate at unity gain	$V_O = 1.4\text{ V to }2.6\text{ V}$ $R_L = 100\text{ k}\Omega$ ‡, $C_L = 100\text{ pF}$ ‡		25°C	0.07	0.12	$\text{V}/\mu\text{s}$	
				Full range	0.05			
$V_n$	Equivalent input noise voltage			25°C	36		$\text{nV}/\sqrt{\text{Hz}}$	
				25°C	19			
$V_{N(PP)}$	Peak-to-peak equivalent input noise voltage			25°C	0.7		$\mu\text{V}$	
				25°C	1.1			
$I_n$	Equivalent input noise current			25°C	0.6		$\text{fA}/\sqrt{\text{Hz}}$	
THD + N	Total harmonic distortion plus noise	$V_O = 0.5\text{ V to }2.5\text{ V}$ , $f = 10\text{ kHz}$ , $R_L = 50\text{ k}\Omega$ ‡		25°C	$A_V = 1$			
					$A_V = 10$			
	Gain-bandwidth product	$f = 10\text{ kHz}$ , $C_L = 100\text{ pF}$ ‡	$R_L = 50\text{ k}\Omega$ ‡,	25°C	0.2		MHz	
BOM	Maximum output-swing bandwidth	$V_{O(PP)} = 2\text{ V}$ , $R_L = 50\text{ k}\Omega$ ‡,	$A_V = 1$ , $C_L = 100\text{ pF}$ ‡	25°C	30		kHz	
$\phi_m$	Phase margin at unity gain	$R_L = 50\text{ k}\Omega$ ‡,	$C_L = 100\text{ pF}$ ‡	25°C	63°			
	Gain margin			25°C	15		dB	

† Full range is 0°C to 70°C.

‡ Referenced to 2.5 V

**TLC225x, TLC225xA**  
**Advanced LinCMOS™ RAIL-TO-RAIL**  
**VERY LOW-POWER OPERATIONAL AMPLIFIERS**

SLOS176D – FEBRUARY 1997 – REVISED MARCH 2001

electrical characteristics at specified free-air temperature,  $V_{DD\pm} = \pm 5\text{ V}$  (unless otherwise specified)

PARAMETER	TEST CONDITIONS	T <sub>A</sub> †	TLC2254C			UNIT
			MIN	TYP	MAX	
V <sub>IO</sub> Input offset voltage	V <sub>IC</sub> = 0, V <sub>O</sub> = 0, R <sub>S</sub> = 50 Ω	25°C	200	1500	μV	
		Full range	1750			
α <sub>VIO</sub> Temperature coefficient of input offset voltage		25°C to 70°C	0.5		μV/°C	
Input offset voltage long-term drift (see Note 4)		25°C	0.003		μV/mo	
I <sub>IO</sub> Input offset current		25°C	0.5	60	pA	
		Full range	100			
I <sub>IB</sub> Input bias current		25°C	1	60	pA	
		Full range	100			
V <sub>ICR</sub> Common-mode input voltage range	V <sub>IO</sub>   ≤ 5 mV, R <sub>S</sub> = 50 Ω	25°C	-5 to 4	-5.3 to 4.2	V	
		Full range	-5 to 3.5			
V <sub>OM+</sub> Maximum positive peak output voltage	I <sub>O</sub> = -20 μA	25°C	4.98		V	
	I <sub>O</sub> = -100 μA	25°C	4.9	4.93		
		Full range	4.7			
	I <sub>O</sub> = -200 μA	25°C	4.8	4.86		
V <sub>OM-</sub> Maximum negative peak output voltage	V <sub>IC</sub> = 0, I <sub>O</sub> = 50 μA	25°C	-4.99		V	
	V <sub>IC</sub> = 0, I <sub>O</sub> = 500 μA	25°C	-4.85	-4.91		
		Full range	-4.85			
	V <sub>IC</sub> = 0, I <sub>O</sub> = 1 mA	25°C	-4.7	-4.8		
		Full range	-4.7			
	V <sub>IC</sub> = 0, I <sub>O</sub> = 4 mA	25°C	-4	-4.3		
Full range		-3.8				
A <sub>VD</sub> Large-signal differential voltage amplification	V <sub>O</sub> = ±4 V	R <sub>L</sub> = 100 kΩ	25°C	40	150	V/mV
		R <sub>L</sub> = 1 MΩ	Full range	10		
			25°C	3000		
r <sub>i(d)</sub> Differential input resistance		25°C	10 <sup>12</sup>		Ω	
r <sub>i(c)</sub> Common-mode input resistance		25°C	10 <sup>12</sup>		Ω	
c <sub>i(c)</sub> Common-mode input capacitance	f = 10 kHz, N package	25°C	8		pF	
z <sub>O</sub> Closed-loop output impedance	f = 25 kHz, A <sub>V</sub> = 10	25°C	190		Ω	
CMRR Common-mode rejection ratio	V <sub>IC</sub> = -5 V to 2.7 V, V <sub>O</sub> = 0, R <sub>S</sub> = 50 Ω	25°C	75	88	dB	
		Full range	75			
k <sub>SVR</sub> Supply-voltage rejection ratio (ΔV <sub>DD±</sub> /ΔV <sub>IO</sub> )	V <sub>DD±</sub> = ±2.2 V to ±8 V, V <sub>IC</sub> = 0, No load	25°C	80	95	dB	
		Full range	80			
I <sub>DD</sub> Supply current (four amplifiers)	V <sub>O</sub> = 0, No load	25°C	160	250	μA	
		Full range	300			

† Full range is 0°C to 70°C.

NOTE 4: Typical values are based on the input offset voltage shift observed through 500 hours of operating life test at T<sub>A</sub> = 150°C extrapolated to T<sub>A</sub> = 25°C using the Arrhenius equation and assuming an activation energy of 0.96 eV.



**TLC225x, TLC225xA**  
**Advanced LinCMOS™ RAIL-TO-RAIL**  
**VERY LOW-POWER OPERATIONAL AMPLIFIERS**

SLOS176D – FEBRUARY 1997 – REVISED MARCH 2001

**operating characteristics at specified free-air temperature,  $V_{DD\pm} = \pm 5\text{ V}$**

PARAMETER		TEST CONDITIONS		$T_A$ †	TLC2254C			UNIT
					MIN	TYP	MAX	
SR	Slew rate at unity gain	$V_O = \pm 1.9\text{ V}$ , $C_L = 100\text{ pF}$	$R_L = 100\text{ k}\Omega$	25°C	0.07	0.12	$\text{V}/\mu\text{s}$	
				Full range	0.05			
$V_n$	Equivalent input noise voltage			25°C	38		$\text{nV}/\sqrt{\text{Hz}}$	
				25°C	19			
$V_{N(PP)}$	Peak-to-peak equivalent input noise voltage			25°C	0.8		$\mu\text{V}$	
				25°C	1.1			
$I_n$	Equivalent input noise current			25°C	0.6		$\text{fA}/\sqrt{\text{Hz}}$	
THD + N	Total harmonic distortion plus noise	$V_O = \pm 2.3\text{ V}$ , $f = 20\text{ kHz}$ , $R_L = 50\text{ k}\Omega$		25°C	$A_V = 1$			
					$A_V = 10$			
	Gain-bandwidth product	$f = 10\text{ kHz}$ , $C_L = 100\text{ pF}$	$R_L = 50\text{ k}\Omega$	25°C	0.21		MHz	
$B_{OM}$	Maximum output-swing bandwidth	$V_{O(PP)} = 4.6\text{ V}$ , $R_L = 50\text{ k}\Omega$	$A_V = 1$ , $C_L = 100\text{ pF}$	25°C	14		kHz	
$\phi_m$	Phase margin at unity gain	$R_L = 50\text{ k}\Omega$	$C_L = 100\text{ pF}$	25°C	63°			
	Gain margin			25°C	15		dB	

† Full range is 0°C to 70°C.

**TLC225x, TLC225xA**  
**Advanced LinCMOS™ RAIL-TO-RAIL**  
**VERY LOW-POWER OPERATIONAL AMPLIFIERS**

SLOS176D – FEBRUARY 1997 – REVISED MARCH 2001

**electrical characteristics at specified free-air temperature,  $V_{DD} = 5\text{ V}$  (unless otherwise noted)**

PARAMETER	TEST CONDITIONS	$T_A$ †	TLC2252I			TLC2252AI			UNIT
			MIN	TYP	MAX	MIN	TYP	MAX	
$V_{IO}$ Input offset voltage	$V_{DD} = \pm 2.5\text{ V}$ , $V_O = 0$ , $R_S = 50\ \Omega$	25°C	200	1500		200	850	$\mu\text{V}$	
		Full range		1750		1000			
$\alpha_{VIO}$ Temperature coefficient of input offset voltage		25°C to 85°C	0.5			0.5			$\mu\text{V}/^\circ\text{C}$
Input offset voltage long-term drift (see Note 4)		25°C	0.003			0.003			$\mu\text{V}/\text{mo}$
$I_{IO}$ Input offset current		25°C	0.5	60		0.5	60	$\text{pA}$	
		Full range		1000		1000			
$I_{IB}$ Input bias current	25°C	1	60		1	60	$\text{pA}$		
	Full range		1000		1000				
$V_{ICR}$ Common-mode input voltage range	$R_S = 50\ \Omega$ , $ V_{IO}  \leq 5\text{ mV}$	25°C	0 to 4	-0.3 to 4.2		0 to 4	-0.3 to 4.2	$\text{V}$	
		Full range	3.5			3.5			
$V_{OH}$ High-level output voltage	$I_{OH} = -20\ \mu\text{A}$	25°C	4.98			4.98			$\text{V}$
	$I_{OH} = -75\ \mu\text{A}$	25°C	4.9	4.94		4.9	4.94		
	Full range	4.8			4.8				
$V_{OL}$ Low-level output voltage	$V_{IC} = 2.5\text{ V}$ , $I_{OL} = 50\ \mu\text{A}$	25°C	0.01			0.01			$\text{V}$
	$V_{IC} = 2.5\text{ V}$ , $I_{OL} = 500\ \mu\text{A}$	25°C	0.09	0.15		0.09	0.15		
		Full range		0.15		0.15			
	$V_{IC} = 2.5\text{ V}$ , $I_{OL} = 4\text{ mA}$	25°C	0.8	1		0.7	1		
Full range			1.2		1.2				
$A_{VD}$ Large-signal differential voltage amplification	$V_{IC} = 2.5\text{ V}$ , $V_O = 1\text{ V to }4\text{ V}$	$R_L = 100\text{ k}\Omega$ ‡	25°C	100	350		100	350	$\text{V}/\text{mV}$
		$R_L = 1\text{ M}\Omega$ ‡	Full range	10			10		
			25°C	1700			1700		
$r_{id}$ Differential input resistance		25°C	$10^{12}$			$10^{12}$			$\Omega$
$r_{ic}$ Common-mode input resistance		25°C	$10^{12}$			$10^{12}$			$\Omega$
$C_{ic}$ Common-mode input capacitance	$f = 10\text{ kHz}$ , P package	25°C	8			8			$\text{pF}$
$z_o$ Closed-loop output impedance	$f = 25\text{ kHz}$ , $A_V = 10$	25°C	200			200			$\Omega$
CMRR Common-mode rejection ratio	$V_{IC} = 0\text{ to }2.7\text{ V}$ , $V_O = 2.5\text{ V}$ , $R_S = 50\ \Omega$	25°C	70	83		70	83	$\text{dB}$	
		Full range	70			70			
kSVR Supply-voltage rejection ratio ( $\Delta V_{DD}/\Delta V_{IO}$ )	$V_{DD} = 4.4\text{ V to }16\text{ V}$ , $V_{IC} = V_{DD}/2$ , No load	25°C	80	95		80	95	$\text{dB}$	
		Full range	80			80			
$I_{DD}$ Supply current	$V_O = 2.5\text{ V}$ , No load	25°C	70	125		70	125	$\mu\text{A}$	
		Full range		150		150			

† Full range is  $-40^\circ\text{C}$  to  $125^\circ\text{C}$ .

‡ Referenced to 2.5 V

NOTE 4: Typical values are based on the input offset voltage shift observed through 500 hours of operating life test at  $T_A = 150^\circ\text{C}$  extrapolated to  $T_A = 25^\circ\text{C}$  using the Arrhenius equation and assuming an activation energy of 0.96 eV.



**TLC225x, TLC225xA**  
**Advanced LinCMOS™ RAIL-TO-RAIL**  
**VERY LOW-POWER OPERATIONAL AMPLIFIERS**

SLOS176D – FEBRUARY 1997 – REVISED MARCH 2001

**operating characteristics at specified free-air temperature,  $V_{DD} = 5\text{ V}$**

PARAMETER	TEST CONDITIONS	$T_A$ †	TLC2252I			TLC2252AI			UNIT	
			MIN	TYP	MAX	MIN	TYP	MAX		
SR	Slew rate at unity gain $V_O = 1.5\text{ V to }3.5\text{ V}$ , $R_L = 100\text{ k}\Omega$ ‡, $C_L = 100\text{ pF}$ ‡	25°C	0.07	0.12		0.07	0.12		V/ $\mu\text{s}$	
		Full range	0.05			0.05				
$V_n$	Equivalent input noise voltage	f = 10 Hz	25°C			36			nV/ $\sqrt{\text{Hz}}$	
		f = 1 kHz	25°C			19				
$V_{N(PP)}$	Peak-to-peak equivalent input noise voltage	f = 0.1 Hz to 1 Hz	25°C			0.7			$\mu\text{V}$	
		f = 0.1 Hz to 10 Hz	25°C			1.1				
$I_n$	Equivalent input noise current	25°C	0.6			0.6			fA/ $\sqrt{\text{Hz}}$	
THD + N	Total harmonic distortion plus noise $V_O = 0.5\text{ V to }2.5\text{ V}$ , f = 10 kHz, $R_L = 50\text{ k}\Omega$ ‡	$A_V = 1$	25°C			0.2%				
		$A_V = 10$	25°C			1%				
	Gain-bandwidth product	f = 50 kHz, $C_L = 100\text{ pF}$ ‡	$R_L = 50\text{ k}\Omega$ ‡,	25°C			0.2			MHz
BOM	Maximum output-swing bandwidth	$V_{O(PP)} = 2\text{ V}$ , $R_L = 50\text{ k}\Omega$ ‡,	$A_V = 1$ , $R_L = 50\text{ k}\Omega$ ‡,	25°C			30			kHz
$\phi_m$	Phase margin at unity gain	$R_L = 50\text{ k}\Omega$ ‡,	$C_L = 100\text{ pF}$ ‡	25°C			63°			
				25°C			15			15

† Full range is –40°C to 125°C.

‡ Referenced to 2.5 V

**TLC225x, TLC225xA**  
**Advanced LinCMOS™ RAIL-TO-RAIL**  
**VERY LOW-POWER OPERATIONAL AMPLIFIERS**

SLOS176D – FEBRUARY 1997 – REVISED MARCH 2001

**electrical characteristics at specified free-air temperature,  $V_{DD\pm} = \pm 5$  V (unless otherwise noted)**

PARAMETER	TEST CONDITIONS	$T_A$ †	TLC2252I			TLC2252AI			UNIT
			MIN	TYP	MAX	MIN	TYP	MAX	
$V_{IO}$ Input offset voltage	$V_{IC} = 0, V_O = 0, R_S = 50 \Omega$	25°C	200	1500		200	850	$\mu V$	
		Full range			1750		1000		
$\alpha_{VIO}$ Temperature coefficient of input offset voltage		25°C to 85°C	0.5			0.5		$\mu V/^\circ C$	
Input offset voltage long-term drift (see Note 4)		25°C	0.003			0.003		$\mu V/mo$	
$I_{IO}$ Input offset current		25°C	0.5	60		0.5	60	$pA$	
		Full range			1000		1000		
$I_{IB}$ Input bias current	25°C	1	60		1	60	$pA$		
	Full range			1000		1000			
$V_{ICR}$ Common-mode input voltage range	$R_S = 50 \Omega,  V_{IO}  \leq 5$ mV	25°C	-5 to 4	-5.3 to 4.2		-5 to 4	-5.3 to 4.2	V	
		Full range	-5 to 3.5			-5 to 3.5			
$V_{OM+}$ Maximum positive peak output voltage	$I_O = -20 \mu A$	25°C		4.98		4.98	V		
	$I_O = -100 \mu A$	25°C	4.9	4.93		4.9		4.93	
		Full range		4.7				4.7	
	$I_O = -200 \mu A$	25°C	4.8	4.86		4.8		4.86	
$V_{OM-}$ Maximum negative peak output voltage	$V_{IC} = 0, I_O = 50 \mu A$	25°C		-4.99		-4.99	V		
	$V_{IC} = 0, I_O = 500 \mu A$	25°C	-4.85	-4.91		-4.85		-4.91	
		Full range		-4.85				-4.85	
	$V_{IC} = 0, I_O = 4$ mA	25°C	-4	-4.3		-4		-4.3	
$AVD$ Large-signal differential voltage amplification	$V_O = \pm 4$ V	$R_L = 50$ k $\Omega$	25°C	40	150		40	150	V/mV
			Full range		10			10	
			$R_L = 1$ M $\Omega$	25°C		3000			
$r_{id}$ Differential input resistance		25°C		10 <sup>12</sup>			10 <sup>12</sup>	$\Omega$	
$r_{ic}$ Common-mode input resistance		25°C		10 <sup>12</sup>			10 <sup>12</sup>	$\Omega$	
$C_{ic}$ Common-mode input capacitance	f = 10 kHz, P package	25°C		8			8	pF	
$Z_o$ Closed-loop output impedance	f = 25 kHz, $A_V = 10$	25°C		190			190	$\Omega$	
CMRR Common-mode rejection ratio	$V_{IC} = -5$ V to 2.7 V, $V_O = 0, R_S = 50 \Omega$	25°C	75	88		75	88	dB	
		Full range		75			75		
$k_{SVR}$ Supply-voltage rejection ratio ( $\Delta V_{DD\pm} / \Delta V_{IO}$ )	$V_{DD} = 4.4$ V to 16 V, $V_{IC} = V_{DD}/2$ , No load	25°C	80	95		80	95	dB	
		Full range		80			80		
$I_{DD}$ Supply current	$V_O = 2.5$ V, No load	25°C	80	125		80	125	$\mu A$	
		Full range			150				150

† Full range is -40°C to 125°C.

NOTE 4: Typical values are based on the input offset voltage shift observed through 500 hours of operating life test at  $T_A = 150^\circ C$  extrapolated to  $T_A = 25^\circ C$  using the Arrhenius equation and assuming an activation energy of 0.96 eV.





**TLC225x, TLC225xA**  
**Advanced LinCMOS™ RAIL-TO-RAIL**  
**VERY LOW-POWER OPERATIONAL AMPLIFIERS**

SLOS176D – FEBRUARY 1997 – REVISED MARCH 2001

**operating characteristics at specified free-air temperature,  $V_{DD\pm} = \pm 5\text{ V}$**

PARAMETER	TEST CONDITIONS	$T_A$ †	TLC2252I			TLC2252AI			UNIT	
			MIN	TYP	MAX	MIN	TYP	MAX		
SR	Slew rate at unity gain $V_O = \pm 1.9\text{ V}$ , $R_L = 100\text{ k}\Omega$ , $C_L = 100\text{ pF}$	25°C	0.07	0.12		0.07	0.12		V/ $\mu\text{s}$	
		Full range	0.05			0.05				
$V_n$	Equivalent input noise voltage	f = 10 Hz	25°C			38			nV/ $\sqrt{\text{Hz}}$	
		f = 1 kHz	25°C			19				
$V_{N(PP)}$	Peak-to-peak equivalent input noise voltage	f = 0.1 Hz to 1 Hz	25°C			0.8			$\mu\text{V}$	
		f = 0.1 Hz to 10 Hz	25°C			1.1				
$I_n$	Equivalent input noise current	25°C	0.6			0.6			fA/ $\sqrt{\text{Hz}}$	
THD + N	Total harmonic distortion plus noise	$V_O = \pm 2.3\text{ V}$ , $R_L = 50\text{ k}\Omega$ , f = 10 kHz	$A_V = 1$	25°C			0.2%			
			$A_V = 10$	25°C			1%			
	Gain-bandwidth product	f = 10 kHz, $C_L = 100\text{ pF}$ , $R_L = 50\text{ k}\Omega$	25°C			0.21			MHz	
BOM	Maximum output-swing bandwidth	$V_{O(PP)} = 4.6\text{ V}$ , $A_V = 1$ , $R_L = 50\text{ k}\Omega$ , $C_L = 100\text{ pF}$	25°C			14			kHz	
$\phi_m$	Phase margin at unity gain	$R_L = 50\text{ k}\Omega$ , $C_L = 100\text{ pF}$	25°C			63°				
	Gain margin		25°C			15			dB	

† Full range is  $-40^\circ\text{C}$  to  $125^\circ\text{C}$ .

**TLC225x, TLC225xA**  
**Advanced LinCMOS™ RAIL-TO-RAIL**  
**VERY LOW-POWER OPERATIONAL AMPLIFIERS**

SLOS176D – FEBRUARY 1997 – REVISED MARCH 2001

**electrical characteristics at specified free-air temperature,  $V_{DD} = 5\text{ V}$  (unless otherwise noted)**

PARAMETER	TEST CONDITIONS	$T_A$ †	TLC2254I			TLC2254AI			UNIT	
			MIN	TYP	MAX	MIN	TYP	MAX		
$V_{IO}$ Input offset voltage		25°C	200		1500	200		850	$\mu\text{V}$	
		Full range	1750			1000				
$\alpha_{VIO}$ Temperature coefficient of input offset voltage	$V_{DD} \pm \pm 2.5\text{ V}$ , $V_{IC} = 0$ , $V_O = 0$ , $R_S = 50\ \Omega$	25°C to 125°C	0.5			0.5			$\mu\text{V}/^\circ\text{C}$	
Input offset voltage long-term drift (see Note 4)		25°C	0.003			0.003			$\mu\text{V}/\text{mo}$	
$I_{IO}$ Input offset current		25°C	0.5	60		0.5	60		$\text{pA}$	
		Full range	1000			1000				
$I_{IB}$ Input bias current	25°C	1	60		1	60		$\text{pA}$		
	Full range	1000			1000					
$V_{ICR}$ Common-mode input voltage range	$R_S = 50\ \Omega$ , $ V_{IO}  \leq 5\text{ mV}$	25°C	0 to 4	-0.3 to 4.2		0 to 4	-0.3 to 4.2	$\text{V}$		
		Full range	0 to 3.5		0 to 3.5					
$V_{OH}$ High-level output voltage	$I_{OH} = -20\ \mu\text{A}$	25°C	4.98			4.98			$\text{V}$	
		25°C	4.9	4.94		4.9	4.94			
		Full range	4.8			4.8				
$V_{OL}$ Low-level output voltage	$V_{IC} = 2.5\text{ V}$ , $I_{OL} = 50\ \mu\text{A}$	25°C	0.01			0.01			$\text{V}$	
		25°C	0.09	0.15		0.09	0.15			
	Full range	0.15			0.15					
	$V_{IC} = 2.5\text{ V}$ , $I_{OL} = 4\text{ mA}$	25°C	0.8	1		0.7	1			
		Full range	1.2			1.2				
$A_{VD}$ Large-signal differential voltage amplification	$V_{IC} = 2.5\text{ V}$ , $V_O = 1\text{ V to }4\text{ V}$	$R_L = 100\text{ k}\Omega$ ‡	25°C	100	350		100	350		$\text{V}/\text{mV}$
			Full range	10			10			
		$R_L = 1\text{ M}\Omega$ ‡	25°C	1700			1700			
$r_{i(d)}$ Differential input resistance		25°C	$10^{12}$			$10^{12}$			$\Omega$	
$r_{i(c)}$ Common-mode input resistance		25°C	$10^{12}$			$10^{12}$			$\Omega$	
$C_{i(c)}$ Common-mode input capacitance	$f = 10\text{ kHz}$ , N package	25°C	8			8			$\text{pF}$	
$Z_o$ Closed-loop output impedance	$f = 25\text{ kHz}$ , $A_V = 10$	25°C	200			200			$\Omega$	
CMRR Common-mode rejection ratio	$V_{IC} = 0\text{ to }2.7\text{ V}$ , $V_O = 2.5\text{ V}$ , $R_S = 50\ \Omega$	25°C	70	83		70	83		$\text{dB}$	
		Full range	70			70				
$k_{SVR}$ Supply-voltage rejection ratio ( $\Delta V_{DD}/\Delta V_{IO}$ )	$V_{DD} = 4.4\text{ V to }16\text{ V}$ , $V_{IC} = V_{DD}/2$ , No load	25°C	80	95		80	95		$\text{dB}$	
		Full range	80			80				
$I_{DD}$ Supply current (four amplifiers)	$V_O = 2.5\text{ V}$ , No load	25°C	140	250		140	250		$\mu\text{A}$	
		Full range	300			300				

† Full range is  $-40^\circ\text{C}$  to  $125^\circ\text{C}$ .

‡ Referenced to 2.5 V

NOTE 4: Typical values are based on the input offset voltage shift observed through 500 hours of operating life test at  $T_A = 150^\circ\text{C}$  extrapolated to  $T_A = 25^\circ\text{C}$  using the Arrhenius equation and assuming an activation energy of 0.96 eV.



**TLC225x, TLC225xA**  
**Advanced LinCMOS™ RAIL-TO-RAIL**  
**VERY LOW-POWER OPERATIONAL AMPLIFIERS**

SLOS176D – FEBRUARY 1997 – REVISED MARCH 2001

**operating characteristics at specified free-air temperature,  $V_{DD} = 5\text{ V}$**

PARAMETER	TEST CONDITIONS	$T_A$ †	TLC2254I			TLC2254AI			UNIT	
			MIN	TYP	MAX	MIN	TYP	MAX		
SR	Slew rate at unity gain $V_O = 1.4\text{ V to }2.6\text{ V}$ , $R_L = 100\text{ k}\Omega$ ‡, $C_L = 100\text{ pF}$ ‡	25°C	0.07	0.12		0.07	0.12		V/ $\mu\text{s}$	
		Full range	0.05			0.05				
$V_n$	Equivalent input noise voltage $f = 10\text{ Hz}$ $f = 1\text{ kHz}$	25°C	36			36			nV/ $\sqrt{\text{Hz}}$	
		25°C	19			19				
$V_{N(PP)}$	Peak-to-peak equivalent input noise voltage $f = 0.1\text{ Hz to }1\text{ Hz}$ $f = 0.1\text{ Hz to }10\text{ Hz}$	25°C	0.7			0.7			$\mu\text{V}$	
		25°C	1.1			1.1				
$I_n$	Equivalent input noise current	25°C	0.6			0.6			fA/ $\sqrt{\text{Hz}}$	
THD + N	Total harmonic distortion plus noise $V_O = 0.5\text{ V to }2.5\text{ V}$ , $f = 20\text{ kHz}$ , $R_L = 50\text{ k}\Omega$ ‡	$A_V = 1$	0.2%			0.2%				
		$A_V = 10$	1%			1%				
	Gain-bandwidth product $f = 50\text{ kHz}$ , $C_L = 100\text{ pF}$ ‡	$R_L = 50\text{ k}\Omega$ ‡, 25°C	0.2			0.2			MHz	
BOM	Maximum output-swing bandwidth $V_{O(PP)} = 2\text{ V}$ , $R_L = 50\text{ k}\Omega$ ‡,	$A_V = 1$ , $C_L = 100\text{ pF}$ ‡	25°C	30			30			kHz
$\phi_m$	Phase margin at unity gain $R_L = 50\text{ k}\Omega$ ‡,	$C_L = 100\text{ pF}$ ‡	25°C	63°			63°			
			25°C	15			15			dB

† Full range is –40°C to 125°C.

‡ Referenced to 2.5 V

**TLC225x, TLC225xA**  
**Advanced LinCMOS™ RAIL-TO-RAIL**  
**VERY LOW-POWER OPERATIONAL AMPLIFIERS**

SLOS176D – FEBRUARY 1997 – REVISED MARCH 2001

**electrical characteristics at specified free-air temperature,  $V_{DD\pm} = \pm 5$  V (unless otherwise noted)**

PARAMETER	TEST CONDITIONS	$T_A$ †	TLC2254I			TLC2254AI			UNIT
			MIN	TYP	MAX	MIN	TYP	MAX	
$V_{IO}$ Input offset voltage	$V_{IC} = 0, V_O = 0, R_S = 50 \Omega$	25°C	200	1500		200	850	$\mu V$	
		Full range			1750		1000		
$\alpha_{VIO}$ Temperature coefficient of input offset voltage		25°C to 125°C	0.5			0.5		$\mu V/^\circ C$	
Input offset voltage long-term drift (see Note 4)		25°C	0.003			0.003		$\mu V/mo$	
$I_{IO}$ Input offset current		25°C	0.5	60		0.5	60	$pA$	
		Full range			1000		1000		
$I_{IB}$ Input bias current	25°C	1	60		1	60	$pA$		
	Full range			1000		1000			
$V_{ICR}$ Common-mode input voltage range	$R_S = 50 \Omega,  V_{IO}  \leq 5$ mV	25°C	-5 to 4	-5.3 to 4.2		-5 to 4	-5.3 to 4.2	V	
		Full range	-5 to 3.5			-5 to 3.5			
$V_{OM+}$ Maximum positive peak output voltage	$I_O = -20 \mu A$	25°C	4.98			4.98	V		
	$I_O = -100 \mu A$	25°C	4.9	4.93		4.9		4.93	
		Full range	4.7			4.7			
	$I_O = -200 \mu A$	25°C	4.8	4.86		4.8		4.86	
$V_{OM-}$ Maximum negative peak output voltage	$V_{IC} = 0, I_O = 50 \mu A$	25°C	-4.99			-4.99	V		
	$V_{IC} = 0, I_O = 500 \mu A$	25°C	-4.85	-4.91		-4.85		-4.91	
		Full range	-4.85			-4.85			
	$V_{IC} = 0, I_O = 4$ mA	25°C	-4	-4.3		-4		-4.3	
$AVD$ Large-signal differential voltage amplification	$V_O = \pm 4$ V	$R_L = 100$ k $\Omega$	25°C	40	150		40	150	V/mV
			Full range	10			10		
		$R_L = 1$ M $\Omega$	25°C	3000			3000		
$r_{i(d)}$ Differential input resistance		25°C	10 <sup>12</sup>			10 <sup>12</sup>	$\Omega$		
$r_{i(c)}$ Common-mode input resistance		25°C	10 <sup>12</sup>			10 <sup>12</sup>	$\Omega$		
$C_{i(c)}$ Common-mode input capacitance	f = 10 kHz, N package	25°C	8			8	pF		
$z_o$ Closed-loop output impedance	f = 25 kHz, $A_V = 10$	25°C	190			190	$\Omega$		
CMRR Common-mode rejection ratio	$V_{IC} = -5$ V to 2.7 V, $V_O = 0, R_S = 50 \Omega$	25°C	75	88		75	88	dB	
		Full range	75			75			
$k_{SVR}$ Supply-voltage rejection ratio ( $\Delta V_{DD\pm}/\Delta V_{IO}$ )	$V_{DD\pm} = \pm 2.2$ V to $\pm 8$ V, $V_{IC} = V_{DD}/2$ , No load	25°C	80	95		80	95	dB	
		Full range	80			80			
$I_{DD}$ Supply current (four amplifiers)	$V_O = 0$ , No load	25°C	160	250		160	250	$\mu A$	
		Full range			300		300		

† Full range is -40°C to 125°C.

NOTE 4: Typical values are based on the input offset voltage shift observed through 500 hours of operating life test at  $T_A = 150^\circ C$  extrapolated to  $T_A = 25^\circ C$  using the Arrhenius equation and assuming an activation energy of 0.96 eV.



**TLC225x, TLC225xA**  
**Advanced LinCMOS™ RAIL-TO-RAIL**  
**VERY LOW-POWER OPERATIONAL AMPLIFIERS**

SLOS176D – FEBRUARY 1997 – REVISED MARCH 2001

**operating characteristics at specified free-air temperature,  $V_{DD\pm} = \pm 5\text{ V}$**

PARAMETER	TEST CONDITIONS	$T_A$ †	TLC2254I			TLC2254AI			UNIT
			MIN	TYP	MAX	MIN	TYP	MAX	
SR	Slew rate at unity gain $V_O = \pm 1.9\text{ V}$ , $C_L = 100\text{ pF}$ , $R_L = 100\text{ k}\Omega$	25°C	0.07	0.12		0.07	0.12		V/ $\mu\text{s}$
		Full range	0.05			0.05			
$V_n$	Equivalent input noise voltage	25°C	38			38			nV/ $\sqrt{\text{Hz}}$
		25°C	19			19			
$V_{N(PP)}$	Peak-to-peak equivalent input noise voltage	25°C	0.8			0.8			$\mu\text{V}$
		25°C	1.1			1.1			
$I_n$	Equivalent input noise current	25°C	0.6			0.6			fA/ $\sqrt{\text{Hz}}$
THD + N	Total harmonic distortion plus noise $V_O = \pm 2.3\text{ V}$ , $R_L = 50\text{ k}\Omega$ , $f = 20\text{ kHz}$	25°C	0.2%			0.2%			
			1%			1%			
	Gain-bandwidth product $f = 10\text{ kHz}$ , $C_L = 100\text{ pF}$ , $R_L = 50\text{ k}\Omega$	25°C	0.21			0.21			MHz
BOM	Maximum output-swing bandwidth $V_{O(PP)} = 4.6\text{ V}$ , $R_L = 50\text{ k}\Omega$ , $A_V = 1$ , $C_L = 100\text{ pF}$	25°C	14			14			kHz
$\phi_m$	Phase margin at unity gain $R_L = 50\text{ k}\Omega$ , $C_L = 100\text{ pF}$	25°C	63°			63°			
		25°C	15			15			

† Full range is  $-40^\circ\text{C}$  to  $125^\circ\text{C}$ .

# TLC225x, TLC225xA Advanced LinCMOS™ RAIL-TO-RAIL VERY LOW-POWER OPERATIONAL AMPLIFIERS

SLOS176D – FEBRUARY 1997 – REVISED MARCH 2001

electrical characteristics at specified free-air temperature,  $V_{DD} = 5\text{ V}$  (unless otherwise noted)

PARAMETER	TEST CONDITIONS	$T_A$ †	TLC2252Q TLC2252M			TLC2252AQ TLC2252AM			UNIT	
			MIN	TYP	MAX	MIN	TYP	MAX		
$V_{IO}$ Input offset voltage	$V_{DD\pm} = \pm 2.5\text{ V}$ , $V_O = 0$ , $V_{IC} = 0$ , $R_S = 50\ \Omega$	25°C	200	1500		200	850	$\mu\text{V}$		
		Full range			1750		1000			
$\alpha_{VIO}$ Temperature coefficient of input offset voltage		25°C to 125°C	0.5			0.5			$\mu\text{V}/^\circ\text{C}$	
Input offset voltage long-term drift (see Note 4)		25°C	0.003			0.003			$\mu\text{V}/\text{mo}$	
$I_{IO}$ Input offset current		25°C	0.5	60		0.5	60	$\text{pA}$		
		Full range			1000		1000			
$I_{IB}$ Input bias current	25°C	1	60		1	60	$\text{pA}$			
	Full range			1000		1000				
$V_{ICR}$ Common-mode input voltage range	$R_S = 50\ \Omega$ , $ V_{IO}  \leq 5\text{ mV}$	25°C	0 to 4	-0.3 to 4.2		0 to 4	-0.3 to 4.2	V		
		Full range	0 to 3.5		0 to 3.5					
$V_{OH}$ High-level output voltage	$I_{OH} = -20\ \mu\text{A}$ $I_{OH} = -75\ \mu\text{A}$ $I_{OH} = -150\ \mu\text{A}$	25°C	4.98			4.98			V	
		25°C	4.9	4.94		4.9	4.94			
		Full range	4.8			4.8				
		25°C	4.8	4.88		4.8	4.88			
$V_{OL}$ Low-level output voltage	$V_{IC} = 2.5\text{ V}$ , $I_{OL} = 50\ \mu\text{A}$ $I_{OL} = 500\ \mu\text{A}$ $I_{OL} = 4\text{ mA}$	25°C	0.01			0.01			V	
		25°C	0.09	0.15		0.09	0.15			
		Full range	0.15			0.15				
		25°C	0.8	1		0.7	1			
		Full range	1.2			1.2				
		25°C	100	350		100	350			
$AVD$ Large-signal differential voltage amplification	$V_{IC} = 2.5\text{ V}$ , $V_O = 1\text{ V to }4\text{ V}$	$R_L = 100\text{ k}\Omega$ ‡	25°C	100			100			V/mV
			Full range	10			10			
		$R_L = 1\text{ M}\Omega$ ‡	25°C	1700			1700			
$r_{id}$ Differential input resistance		25°C	$10^{12}$			$10^{12}$			$\Omega$	
$r_{ic}$ Common-mode input resistance		25°C	$10^{12}$			$10^{12}$			$\Omega$	
$c_{ic}$ Common-mode input capacitance	$f = 10\text{ kHz}$ , $f = 10\text{ kHz}$	25°C	8			8			pF	
$z_o$ Closed-loop output impedance	$f = 25\text{ kHz}$ , $A_V = 10$	25°C	200			200			$\Omega$	
CMRR Common-mode rejection ratio	$V_{IC} = 0\text{ to }2.7\text{ V}$ , $R_S = 50\ \Omega$ , $V_O = 2.5\text{ V}$	25°C	70	83		70	83	dB		
		Full range	70			70				
$k_{SVR}$ Supply-voltage rejection ratio ( $\Delta V_{DD}/\Delta V_{IO}$ )	$V_{DD} = 4.4\text{ V to }16\text{ V}$ , $V_{IC} = V_{DD}/2$ , No load	25°C	80	95		80	95	dB		
		Full range	80			80				
$I_{DD}$ Supply current	$V_O = 2.5\text{ V}$ , No load	25°C	70	125		70	125	$\mu\text{A}$		
		Full range	150			150				

† Full range is  $-40^\circ\text{C}$  to  $125^\circ\text{C}$  for Q suffix,  $-55^\circ\text{C}$  to  $125^\circ\text{C}$  for M suffix.

‡ Referenced to 2.5 V

NOTE 4: Typical values are based on the input offset voltage shift observed through 500 hours of operating life test at  $T_A = 150^\circ\text{C}$  extrapolated to  $T_A = 25^\circ\text{C}$  using the Arrhenius equation and assuming an activation energy of 0.96 eV.



**TLC225x, TLC225xA**  
**Advanced LinCMOS™ RAIL-TO-RAIL**  
**VERY LOW-POWER OPERATIONAL AMPLIFIERS**

SLOS176D – FEBRUARY 1997 – REVISED MARCH 2001

**operating characteristics at specified free-air temperature,  $V_{DD} = 5\text{ V}$**

PARAMETER	TEST CONDITIONS	$T_A$ †	TLC2252Q TLC2252M			TLC2252AQ TLC2252AM			UNIT
			MIN	TYP	MAX	MIN	TYP	MAX	
SR	Slew rate at unity gain $V_O = 0.5\text{ V to }3.5\text{ V}$ , $R_L = 100\text{ k}\Omega$ ‡, $C_L = 100\text{ pF}$ ‡	25°C	0.07	0.12		0.07	0.12		V/ $\mu$ s
		Full range	0.05			0.05			
$V_n$	Equivalent input noise voltage $f = 10\text{ Hz}$ $f = 1\text{ kHz}$	25°C	36			36			nV/ $\sqrt{\text{Hz}}$
		25°C	19			19			
$V_{N(PP)}$	Peak-to-peak equivalent input noise voltage $f = 0.1\text{ Hz to }1\text{ Hz}$ $f = 0.1\text{ Hz to }10\text{ Hz}$	25°C	0.7			0.7			$\mu$ V
		25°C	1.1			1.1			
$I_n$	Equivalent input noise current	25°C	0.6			0.6			fA/ $\sqrt{\text{Hz}}$
THD + N	Total harmonic distortion plus noise $V_O = 0.5\text{ V to }2.5\text{ V}$ , $f = 10\text{ kHz}$ , $R_L = 50\text{ k}\Omega$ ‡	$A_V = 1$	0.2%			0.2%			
		$A_V = 10$	1%			1%			
	Gain-bandwidth product $f = 50\text{ kHz}$ , $C_L = 100\text{ pF}$ ‡	$R_L = 50\text{ k}\Omega$ ‡, 25°C	0.2			0.2			MHz
$B_{OM}$	Maximum output-swing bandwidth $V_{O(PP)} = 2\text{ V}$ , $R_L = 50\text{ k}\Omega$ ‡, $A_V = 1$ , $C_L = 100\text{ pF}$ ‡	25°C	30			30			kHz
$\phi_m$	Phase margin at unity gain $R_L = 50\text{ k}\Omega$ ‡, $C_L = 100\text{ pF}$ ‡	25°C	63°			63°			
		25°C	15			15			dB

† Full range is – 40°C to 125°C for Q suffix, – 55°C to 125°C for M suffix.

‡ Referenced to 2.5 V

**TLC225x, TLC225xA**  
**Advanced LinCMOS™ RAIL-TO-RAIL**  
**VERY LOW-POWER OPERATIONAL AMPLIFIERS**

SLOS176D – FEBRUARY 1997 – REVISED MARCH 2001

**electrical characteristics at specified free-air temperature,  $V_{DD\pm} = \pm 5$  V (unless otherwise noted)**

PARAMETER	TEST CONDITIONS	$T_A$ †	TLC2252Q TLC2252M			TLC2252AQ TLC2252AM			UNIT
			MIN	TYP	MAX	MIN	TYP	MAX	
$V_{IO}$ Input offset voltage	$V_{IC} = 0, V_O = 0, R_S = 50 \Omega$	25°C	200	1500		200	850	$\mu V$	
		Full range			1750		1000		
$\alpha V_{IO}$ Temperature coefficient of input offset voltage		25°C to 125°C	0.5			0.5		$\mu V/^\circ C$	
Input offset voltage long-term drift (see Note 4)		25°C	0.003			0.003		$\mu V/mo$	
$I_{IO}$ Input offset current		25°C	0.5	60		0.5	60	$pA$	
		Full range			1000		1000		
$I_{IB}$ Input bias current	25°C	1	60		1	60	$pA$		
	Full range			1000		1000			
$V_{ICR}$ Common-mode input voltage range	$R_S = 50 \Omega,  V_{IO}  \leq 5 mV$	25°C	-5 to 4	-5.3 to 4.2		-5 to 4	-5.3 to 4.2	V	
		Full range	-5 to 3.5			-5 to 3.5			
$V_{OM+}$ Maximum positive peak output voltage	$I_O = -20 \mu A$	25°C	4.98			4.98	V		
	$I_O = -100 \mu A$	25°C	4.9	4.93		4.9		4.93	
		Full range	4.7			4.7			
	$I_O = -200 \mu A$	25°C	4.8	4.86		4.8		4.86	
$V_{OM-}$ Maximum negative peak output voltage	$V_{IC} = 0, I_O = 50 \mu A$	25°C	-4.99			-4.99	V		
	$V_{IC} = 0, I_O = 500 \mu A$	25°C	-4.85	-4.91		-4.85		-4.91	
		Full range	-4.85			-4.85			
	$V_{IC} = 0, I_O = 4 mA$	25°C	-4	-4.3		-4		-4.3	
		Full range	-3.8			-3.8			
$AVD$ Large-signal differential voltage amplification	$V_O = \pm 4 V$	$R_L = 100 k\Omega$	25°C	40	150		40	150	V/mV
			Full range	10			10		
		$R_L = 1 M\Omega$	25°C	3000			3000		
$r_{id}$ Differential input resistance		25°C	$10^{12}$			$10^{12}$	$\Omega$		
$r_{ic}$ Common-mode input resistance		25°C	$10^{12}$			$10^{12}$	$\Omega$		
$c_{ic}$ Common-mode input capacitance	$f = 10 kHz, P$ package	25°C	8			8	pF		
$z_o$ Closed-loop output impedance	$f = 25 kHz, A_V = 10$	25°C	190			190	$\Omega$		
CMRR Common-mode rejection ratio	$V_{IC} = -5 V$ to 2.7 V, $V_O = 0, R_S = 50 \Omega$	25°C	75	88		75	88	dB	
		Full range	75			75			
$k_{SVR}$ Supply-voltage rejection ratio ( $\Delta V_{DD\pm} / \Delta V_{IO}$ )	$V_{DD} = \pm 2.2 V$ to $\pm 8 V, V_{IC} = 0, No load$	25°C	80	95		80	95	dB	
		Full range	80			80			
$I_{DD}$ Supply current	$V_O = 2.5 V, No load$	25°C	80	125		80	125	$\mu A$	
		Full range			150		150		

† Full range is -40°C to 125°C for Q suffix, -55°C to 125°C for M suffix.

NOTE 4: Typical values are based on the input offset voltage shift observed through 500 hours of operating life test at  $T_A = 150^\circ C$  extrapolated to  $T_A = 25^\circ C$  using the Arrhenius equation and assuming an activation energy of 0.96 eV.





**TLC225x, TLC225xA**  
**Advanced LinCMOS™ RAIL-TO-RAIL**  
**VERY LOW-POWER OPERATIONAL AMPLIFIERS**

SLOS176D – FEBRUARY 1997 – REVISED MARCH 2001

**operating characteristics at specified free-air temperature,  $V_{DD\pm} = \pm 5\text{ V}$**

PARAMETER	TEST CONDITIONS	$T_A$ †	TLC2252Q TLC2252M			TLC2252AQ TLC2252AM			UNIT
			MIN	TYP	MAX	MIN	TYP	MAX	
SR	Slew rate at unity gain $V_O = \pm 2\text{ V}$ , $C_L = 100\text{ pF}$ , $R_L = 100\text{ k}\Omega$	25°C	0.07	0.12		0.07	0.12		$\text{V}/\mu\text{s}$
		Full range	0.05			0.05			
$V_n$	Equivalent input noise voltage	25°C		38			38		$\text{nV}/\sqrt{\text{Hz}}$
		25°C		19			19		
$V_{N(PP)}$	Peak-to-peak equivalent input noise voltage	25°C		0.8			0.8		$\mu\text{V}$
		25°C		1.1			1.1		
$I_n$	Equivalent input noise current	25°C		0.6			0.6	$\text{fA}/\sqrt{\text{Hz}}$	
THD + N	Total harmonic distortion plus noise $V_O = \pm 2.3\text{ V}$ , $R_L = 50\text{ k}\Omega$ , $f = 10\text{ kHz}$	25°C		0.2%			0.2%		
		25°C		1%			1%		
	Gain-bandwidth product $f = 10\text{ kHz}$ , $C_L = 100\text{ pF}$ , $R_L = 50\text{ k}\Omega$	25°C		0.21			0.21	MHz	
BOM	Maximum output-swing bandwidth $V_{O(PP)} = 4.6\text{ V}$ , $R_L = 50\text{ k}\Omega$ , $A_V = 1$ , $C_L = 100\text{ pF}$	25°C		14			14	kHz	
$\phi_m$	Phase margin at unity gain $R_L = 50\text{ k}\Omega$ , $C_L = 100\text{ pF}$	25°C		63°			63°		
		25°C		15			15	dB	

† Full range is – 40°C to 125°C for Q suffix, – 55°C to 125°C for M suffix.

# TLC225x, TLC225xA Advanced LinCMOS™ RAIL-TO-RAIL VERY LOW-POWER OPERATIONAL AMPLIFIERS

SLOS176D – FEBRUARY 1997 – REVISED MARCH 2001

electrical characteristics at specified free-air temperature,  $V_{DD} = 5\text{ V}$  (unless otherwise noted)

PARAMETER	TEST CONDITIONS	$T_A$ †	TLC2254Q TLC2254M			TLC2254AQ TLC2254AM			UNIT
			MIN	TYP	MAX	MIN	TYP	MAX	
$V_{IO}$ Input offset voltage		25°C	200	1500		200	850	$\mu\text{V}$	
		Full range		1750		1000			
$\alpha_{VIO}$ Temperature coefficient of input offset voltage		25°C to 125°C	0.5			0.5			$\mu\text{V}/^\circ\text{C}$
Input offset voltage long-term drift (see Note 4)	$V_{DD\pm} = \pm 2.5\text{ V}$ , $V_{IC} = 0$ , $V_O = 0$ , $R_S = 50\ \Omega$	25°C	0.003			0.003			$\mu\text{V}/\text{mo}$
$I_{IO}$ Input offset current		25°C	0.5	60		0.5	60	pA	
		125°C	1000			1000			
$I_{IB}$ Input bias current		25°C	1	60		1	60	pA	
	125°C	1000			1000				
$V_{ICR}$ Common-mode input voltage range	$R_S = 50\ \Omega$ , $ V_{IO}  \leq 5\text{ mV}$	25°C	0 to 4	-0.3 to 4.2		0 to 4	-0.3 to 4.2	V	
		Full range	0 to 3.5		0 to 3.5				
$V_{OH}$ High-level output voltage	$I_{OH} = -20\ \mu\text{A}$	25°C	4.98			4.98			V
	$I_{OH} = -75\ \mu\text{A}$	25°C	4.9	4.94		4.9	4.94		
	Full range	4.8			4.8				
	$I_{OH} = -150\ \mu\text{A}$	25°C	4.8	4.88		4.8	4.88		
$V_{OL}$ Low-level output voltage	$V_{IC} = 2.5\text{ V}$ , $I_{OL} = 50\ \mu\text{A}$	25°C	0.01			0.01			V
	$V_{IC} = 2.5\text{ V}$ , $I_{OL} = 500\ \mu\text{A}$	25°C	0.09	0.15		0.09	0.15		
		Full range	0.15			0.15			
	$V_{IC} = 2.5\text{ V}$ , $I_{OL} = 4\text{ mA}$	25°C	0.8	1		0.7	1		
		Full range	1.2			1.2			
$A_{VD}$ Large-signal differential voltage amplification	$V_{IC} = 2.5\text{ V}$ , $V_O = 1\text{ V to }4\text{ V}$	$R_L = 100\text{ k}\Omega$ ‡	25°C	100	350		100	350	V/mV
		Full range	10			10			
		$R_L = 1\text{ M}\Omega$ ‡	25°C	1700			1700		
$r_{i(d)}$ Differential input resistance		25°C	1012			1012			$\Omega$
$r_{i(c)}$ Common-mode input resistance		25°C	1012			1012			$\Omega$
$C_{i(c)}$ Common-mode input capacitance	$f = 10\text{ kHz}$ , N package	25°C	8			8			pF
$z_o$ Closed-loop output impedance	$f = 25\text{ kHz}$ , $A_V = 10$	25°C	200			200			$\Omega$
CMRR Common-mode rejection ratio	$V_{IC} = 0\text{ to }2.7\text{ V}$ , $V_O = 2.5\text{ V}$ , $R_S = 50\ \Omega$	25°C	70	83		70	83	dB	
		Full range	70			70			
$k_{SVR}$ Supply-voltage rejection ratio ( $\Delta V_{DD}/\Delta V_{IO}$ )	$V_{DD} = 4.4\text{ V to }16\text{ V}$ , $V_{IC} = V_{DD}/2$ , No load	25°C	80	95		80	95	dB	
		Full range	80			80			
$I_{DD}$ Supply current (four amplifiers)	$V_O = 2.5\text{ V}$ , No load	25°C	140	250		140	250	$\mu\text{A}$	
		Full range	300			300			

† Full range is  $-40^\circ\text{C}$  to  $125^\circ\text{C}$  for Q suffix,  $-55^\circ\text{C}$  to  $125^\circ\text{C}$  for M suffix.

‡ Referenced to 2.5 V

NOTE 4: Typical values are based on the input offset voltage shift observed through 500 hours of operating life test at  $T_A = 150^\circ\text{C}$  extrapolated to  $T_A = 25^\circ\text{C}$  using the Arrhenius equation and assuming an activation energy of 0.96 eV.



**TLC225x, TLC225xA**  
**Advanced LinCMOS™ RAIL-TO-RAIL**  
**VERY LOW-POWER OPERATIONAL AMPLIFIERS**

SLOS176D – FEBRUARY 1997 – REVISED MARCH 2001

**operating characteristics at specified free-air temperature,  $V_{DD} = 5\text{ V}$**

PARAMETER	TEST CONDITIONS	$T_A$ †	TLC2254Q TLC2254M			TLC2254AQ TLC2254AM			UNIT
			MIN	TYP	MAX	MIN	TYP	MAX	
SR	Slew rate at unity gain $V_O = 0.5\text{ V to }3.5\text{ V}$ , $R_L = 100\text{ k}\Omega$ ‡, $C_L = 100\text{ pF}$ ‡	25°C	0.07	0.12		0.07	0.12		V/ $\mu$ s
		Full range	0.05			0.05			
$V_n$	Equivalent input noise voltage	$f = 10\text{ Hz}$	36			36			nV/ $\sqrt{\text{Hz}}$
		$f = 1\text{ kHz}$	19			19			
$V_{N(PP)}$	Peak-to-peak equivalent input noise voltage	$f = 0.1\text{ Hz to }1\text{ Hz}$	0.7			0.7			$\mu$ V
		$f = 0.1\text{ Hz to }10\text{ Hz}$	1.1			1.1			
$I_n$	Equivalent input noise current	25°C	0.6			0.6			fA/ $\sqrt{\text{Hz}}$
THD + N	Total harmonic distortion plus noise $V_O = 0.5\text{ V to }2.5\text{ V}$ , $f = 20\text{ kHz}$ , $R_L = 50\text{ k}\Omega$ ‡	$A_V = 1$	0.2%			0.2%			
		$A_V = 10$	1%			1%			
	Gain-bandwidth product $f = 50\text{ kHz}$ , $C_L = 100\text{ pF}$ ‡	$R_L = 50\text{ k}\Omega$ ‡, 25°C	0.2			0.2			MHz
$B_{OM}$	Maximum output-swing bandwidth $V_{O(PP)} = 2\text{ V}$ , $R_L = 50\text{ k}\Omega$ ‡, $A_V = 1$ , $C_L = 100\text{ pF}$ ‡	25°C	30			30			kHz
$\phi_m$	Phase margin at unity gain $R_L = 50\text{ k}\Omega$ ‡, $C_L = 100\text{ pF}$ ‡	25°C	63°			63°			
		25°C	15			15			dB

† Full range is – 40°C to 125°C for Q suffix, – 55°C to 125°C for M suffix.

‡ Referenced to 2.5 V

**TLC225x, TLC225xA**  
**Advanced LinCMOS™ RAIL-TO-RAIL**  
**VERY LOW-POWER OPERATIONAL AMPLIFIERS**

SLOS176D – FEBRUARY 1997 – REVISED MARCH 2001

**electrical characteristics at specified free-air temperature,  $V_{DD\pm} = \pm 5$  V (unless otherwise noted)**

PARAMETER	TEST CONDITIONS	$T_A$ †	TLC2254Q TLC2254M			TLC2254AQ TLC2254AM			UNIT
			MIN	TYP	MAX	MIN	TYP	MAX	
$V_{IO}$ Input offset voltage	$V_{IC} = 0, V_O = 0, R_S = 50 \Omega$	25°C	200	1500		200	850	$\mu V$	
		Full range			1750		1000		
$\alpha V_{IO}$ Temperature coefficient of input offset voltage		25°C to 125°C	0.5			0.5		$\mu V/^\circ C$	
Input offset voltage long-term drift (see Note 4)		25°C	0.003			0.003		$\mu V/mo$	
$I_{IO}$ Input offset current		25°C	0.5	60		0.5	60	$pA$	
		125°C			1000		1000		
$I_{IB}$ Input bias current	25°C	1	60		1	60	$pA$		
	125°C			1000		1000			
$V_{ICR}$ Common-mode input voltage range	$R_S = 50 \Omega,  V_{IO}  \leq 5 mV$	25°C	-5 to 4	-5.3 to 4.2		-5 to 4	-5.3 to 4.2	V	
		Full range	-5 to 3.5			-5 to 3.5			
$V_{OM+}$ Maximum positive peak output voltage	$I_O = -20 \mu A$	25°C	4.98			4.98	V		
	$I_O = -100 \mu A$	25°C	4.9	4.93		4.9		4.93	
		Full range	4.7			4.7			
$V_{OM-}$ Maximum negative peak output voltage	$V_{IC} = 0, I_O = 50 \mu A$	25°C	-4.99			-4.99	V		
	$V_{IC} = 0, I_O = 500 \mu A$	25°C	-4.85	-4.91		-4.85		-4.91	
		Full range	-4.85			-4.85			
	$V_{IC} = 0, I_O = 4 mA$	25°C	-4	-4.3		-4		-4.3	
		Full range	-3.8			-3.8			
$A_{VD}$ Large-signal differential voltage amplification	$V_O = \pm 4 V$	$R_L = 100 k\Omega$	25°C	40	150		40	150	V/mV
			Full range	10			10		
		$R_L = 1 M\Omega$	25°C	3000			3000		
$r_{i(d)}$ Differential input resistance		25°C	10 <sup>12</sup>			10 <sup>12</sup>	$\Omega$		
$r_{i(c)}$ Common-mode input resistance		25°C	10 <sup>12</sup>			10 <sup>12</sup>	$\Omega$		
$C_{i(c)}$ Common-mode input capacitance	$f = 10 kHz, N$ package	25°C	8			8	pF		
$Z_o$ Closed-loop output impedance	$f = 25 kHz, A_V = 10$	25°C	190			190	$\Omega$		
CMRR Common-mode rejection ratio	$V_{IC} = -5 V$ to 2.7 V, $V_O = 0, R_S = 50 \Omega$	25°C	75	88		75	88	dB	
		Full range	75			75			
$k_{SVR}$ Supply-voltage rejection ratio ( $\Delta V_{DD\pm} / \Delta V_{IO}$ )	$V_{DD\pm} = \pm 2.2 V$ to $\pm 8 V, V_{IC} = V_{DD}/2, No load$	25°C	80	95		80	95	dB	
		Full range	80			80			
$I_{DD}$ Supply current (four amplifiers)	$V_O = 0, No load$	25°C	160	250		160	250	$\mu A$	
		Full range			300		300		

† Full range is -40°C to 125°C for Q suffix, -55°C to 125°C for M suffix.

NOTE 4: Typical values are based on the input offset voltage shift observed through 500 hours of operating life test at  $T_A = 150^\circ C$  extrapolated to  $T_A = 25^\circ C$  using the Arrhenius equation and assuming an activation energy of 0.96 eV.



**TLC225x, TLC225xA**  
**Advanced LinCMOS™ RAIL-TO-RAIL**  
**VERY LOW-POWER OPERATIONAL AMPLIFIERS**

SLOS176D – FEBRUARY 1997 – REVISED MARCH 2001

**operating characteristics at specified free-air temperature,  $V_{DD\pm} = \pm 5\text{ V}$**

PARAMETER	TEST CONDITIONS		$T_A$ †	TLC2254Q TLC2254M			TLC2254AQ TLC2254AM			UNIT
				MIN	TYP	MAX	MIN	TYP	MAX	
SR Slew rate at unity gain	$V_O = \pm 2\text{ V}$ , $C_L = 100\text{ pF}$	$R_L = 100\text{ k}\Omega$ ,	25°C	0.07	0.12		0.07	0.12		V/ $\mu\text{s}$
			Full range	0.05			0.05			
$V_n$ Equivalent input noise voltage	$f = 10\text{ Hz}$		25°C	38			38			nV/ $\sqrt{\text{Hz}}$
	$f = 1\text{ kHz}$		25°C	19			19			
$V_{N(PP)}$ Peak-to-peak equivalent input noise voltage	$f = 0.1\text{ Hz to }1\text{ Hz}$		25°C	0.8			0.8			$\mu\text{V}$
	$f = 0.1\text{ Hz to }10\text{ Hz}$		25°C	1.1			1.1			
$I_n$ Equivalent input noise current			25°C	0.6			0.6			fA/ $\sqrt{\text{Hz}}$
THD + N Total harmonic distortion plus noise	$V_O = \pm 2.3\text{ V}$ , $R_L = 50\text{ k}\Omega$ , $f = 20\text{ kHz}$	$A_V = 1$	25°C	0.2%			0.2%			
		$A_V = 10$		1%			1%			
Gain-bandwidth product	$f = 10\text{ kHz}$ , $C_L = 100\text{ pF}$	$R_L = 50\text{ k}\Omega$ ,	25°C	0.21			0.21			MHz
$B_{OM}$ Maximum output-swing bandwidth	$V_{O(PP)} = 4.6\text{ V}$ , $R_L = 50\text{ k}\Omega$ ,	$A_V = 1$ , $C_L = 100\text{ pF}$	25°C	14			14			kHz
$\phi_m$ Phase margin at unity gain	$R_L = 50\text{ k}\Omega$ ,	$C_L = 100\text{ pF}$	25°C	63°			63°			
			Gain margin	25°C	15			15		

† Full range is – 40°C to 125°C for Q suffix, – 55°C to 125°C for M suffix.

**TLC225x, TLC225xA**  
**Advanced LinCMOS™ RAIL-TO-RAIL**  
**VERY LOW-POWER OPERATIONAL AMPLIFIERS**

SLOS176D – FEBRUARY 1997 – REVISED MARCH 2001

**TYPICAL CHARACTERISTICS**

**Table of Graphs**

		<b>FIGURE</b>	
$V_{IO}$	Input offset voltage	Distribution vs Common-mode input voltage	2 – 5 6, 7
$\alpha V_{IO}$	Input offset voltage temperature coefficient	Distribution	8 – 11
$I_{IB}/I_{IO}$	Input bias and input offset currents	vs Free-air temperature	12
$V_I$	Input voltage range	vs Supply voltage vs Free-air temperature	13 14
$V_{OH}$	High-level output voltage	vs High-level output current	15
$V_{OL}$	Low-level output voltage	vs Low-level output current	16, 17
$V_{OM+}$	Maximum positive peak output voltage	vs Output current	18
$V_{OM-}$	Maximum negative peak output voltage	vs Output current	19
$V_{O(PP)}$	Maximum peak-to-peak output voltage	vs Frequency	20
$I_{OS}$	Short-circuit output current	vs Supply voltage vs Free-air temperature	21 22
$V_O$	Output voltage	vs Differential input voltage	23, 24
	Differential gain	vs Load resistance	25
$A_{VD}$	Large-signal differential voltage amplification	vs Frequency vs Free-air temperature	26, 27 28, 29
$z_o$	Output impedance	vs Frequency	30, 31
CMRR	Common-mode rejection ratio	vs Frequency vs Free-air temperature	32 33
$k_{SVR}$	Supply-voltage rejection ratio	vs Frequency vs Free-air temperature	34, 35 36
$I_{DD}$	Supply current	vs Supply voltage vs Free-air temperature	37 38
SR	Slew rate	vs Load capacitance vs Free-air temperature	39 40
$V_O$	Inverting large-signal pulse response		41, 42
$V_O$	Voltage-follower large-signal pulse response		43, 44
$V_O$	Inverting small-signal pulse response		45, 46
$V_O$	Voltage-follower small-signal pulse response		47, 48
$V_n$	Equivalent input noise voltage	vs Frequency	49, 50
	Noise voltage (referred to input)	Over a 10-second period	51
	Integrated noise voltage	vs Frequency	52
THD + N	Total harmonic distortion plus noise	vs Frequency	53
	Gain-bandwidth product	vs Free-air temperature vs Supply voltage	54 55
$\phi_m$	Phase margin	vs Frequency vs Load capacitance	26, 27 56
$A_m$	Gain margin	vs Load capacitance	57
$B_1$	Unity-gain bandwidth	vs Load capacitance	58
	Overestimation of phase margin	vs Load capacitance	59



**TYPICAL CHARACTERISTICS**

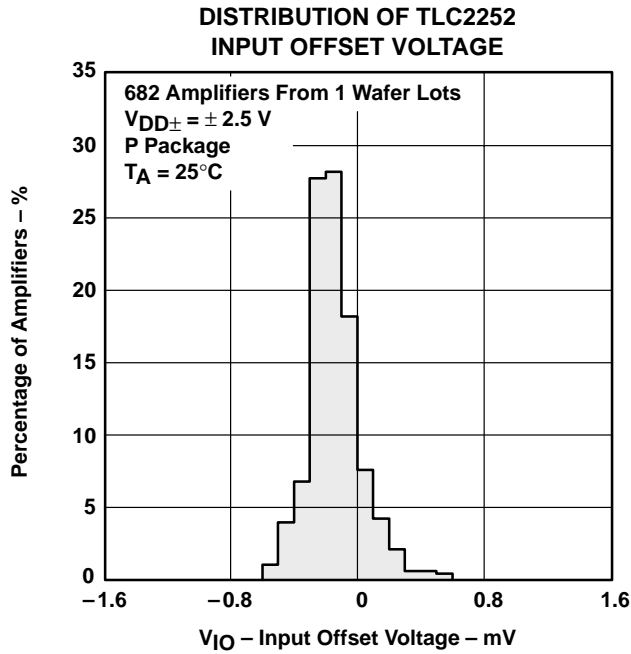

**Figure 2**

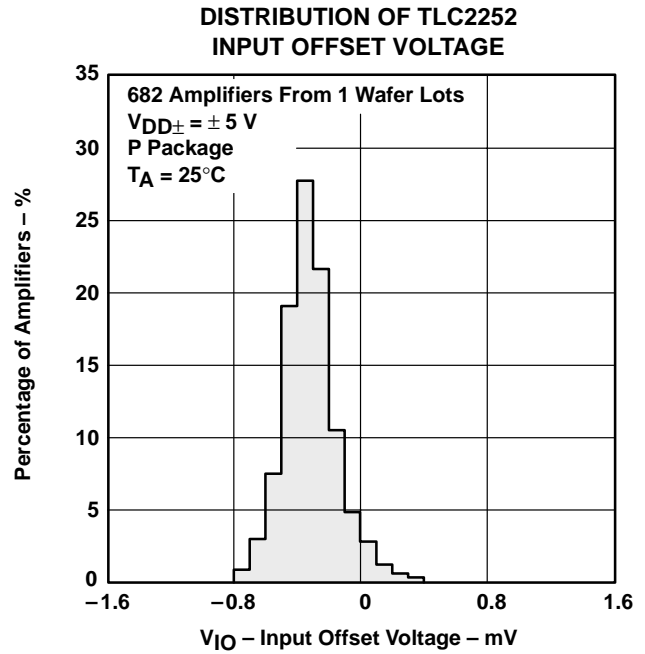

**Figure 3**

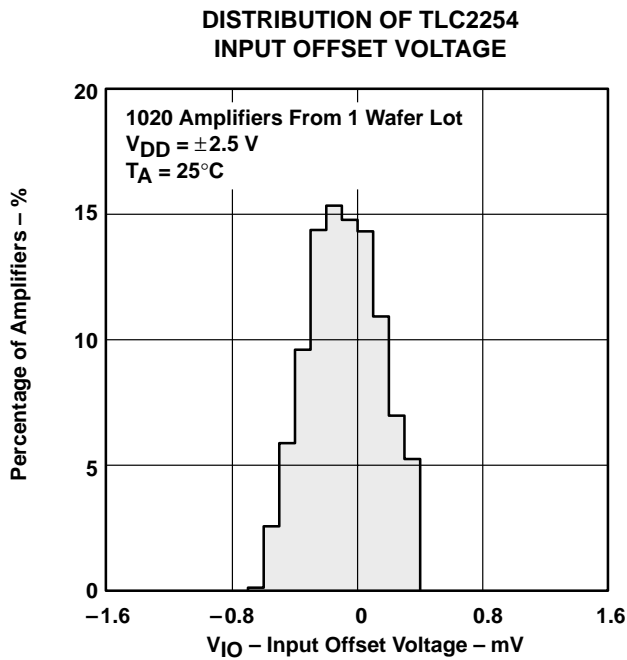

**Figure 4**

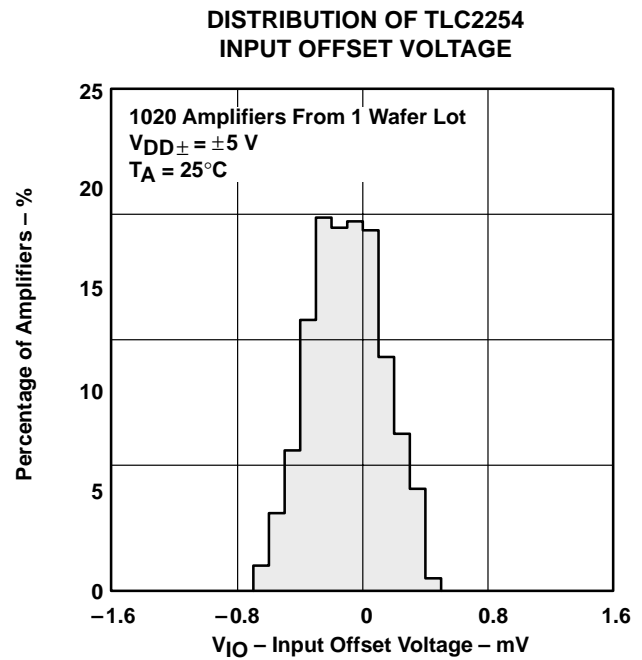

**Figure 5**

TYPICAL CHARACTERISTICS

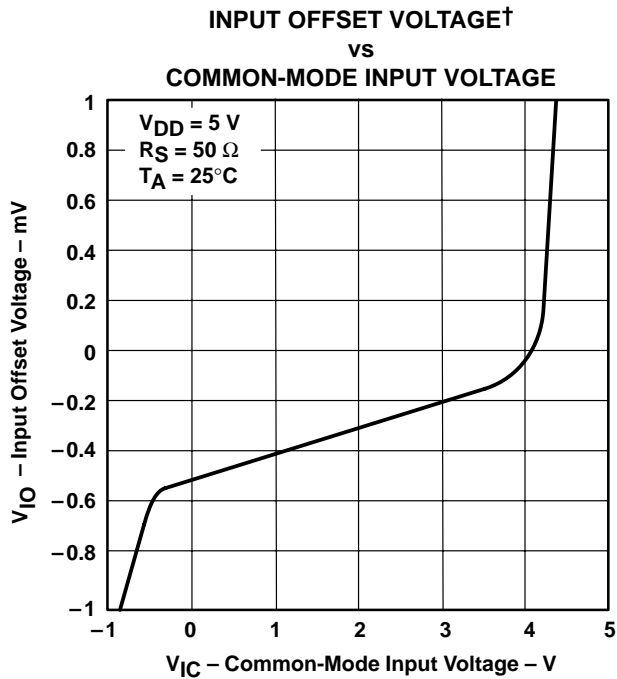

Figure 6

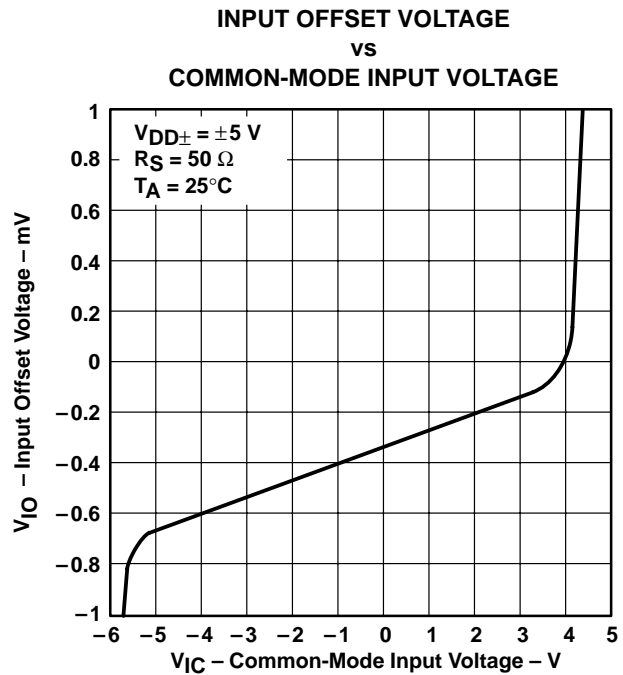

Figure 7

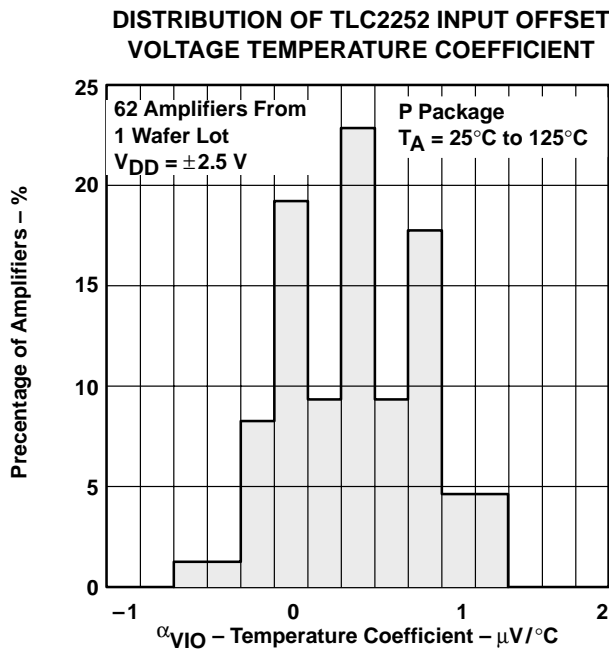

Figure 8

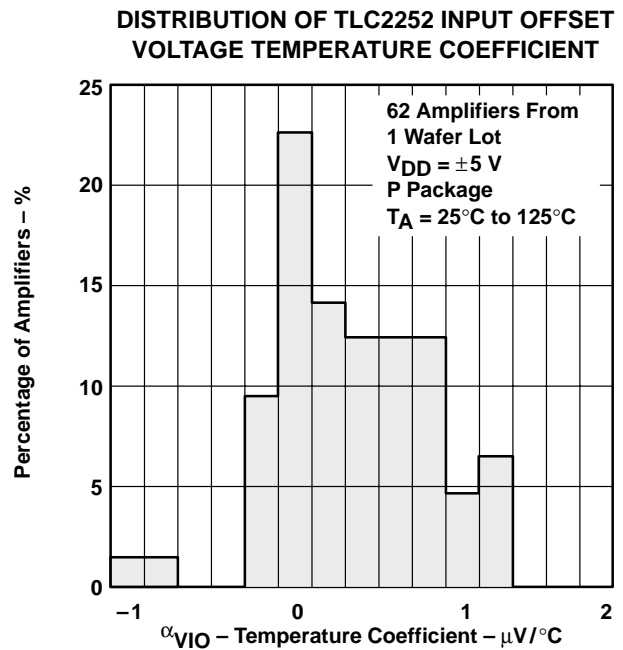

Figure 9

† For curves where  $V_{DD} = 5\text{ V}$ , all loads are referenced to 2.5 V.



TYPICAL CHARACTERISTICS

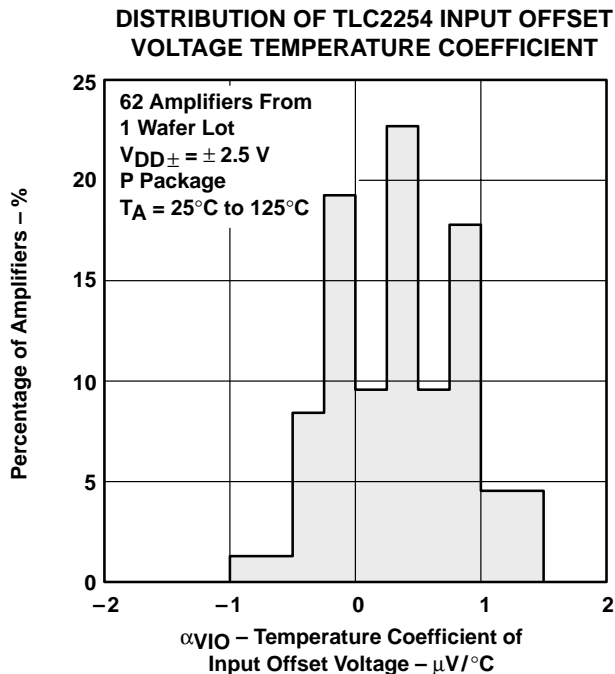

Figure 10



Figure 11

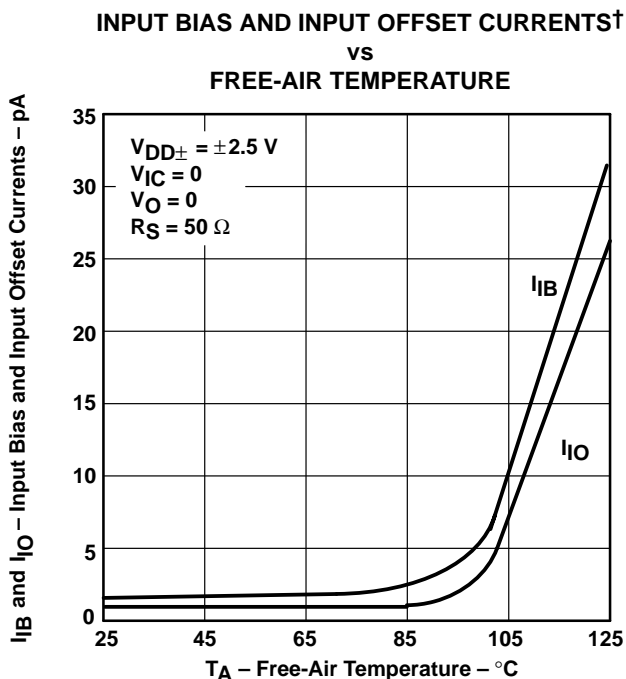

Figure 12



Figure 13

† Data at high and low temperatures are applicable only within the rated operating free-air temperature ranges of the various devices.

**TYPICAL CHARACTERISTICS**

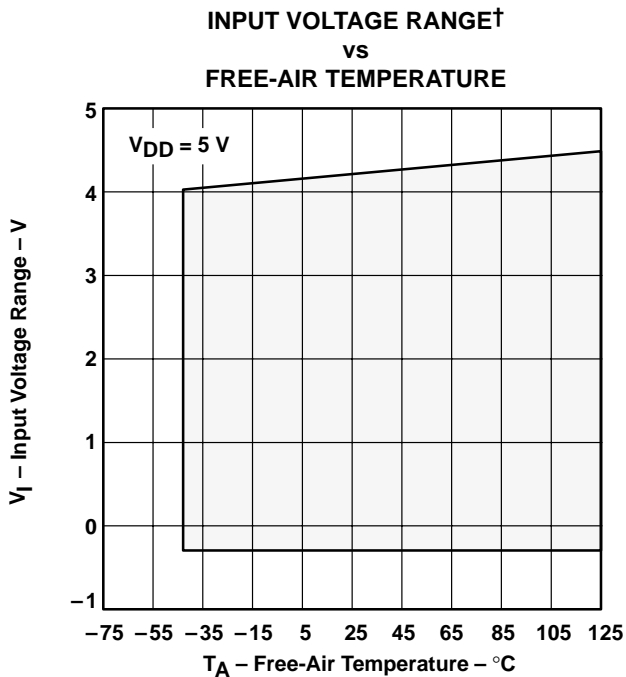

**Figure 14**

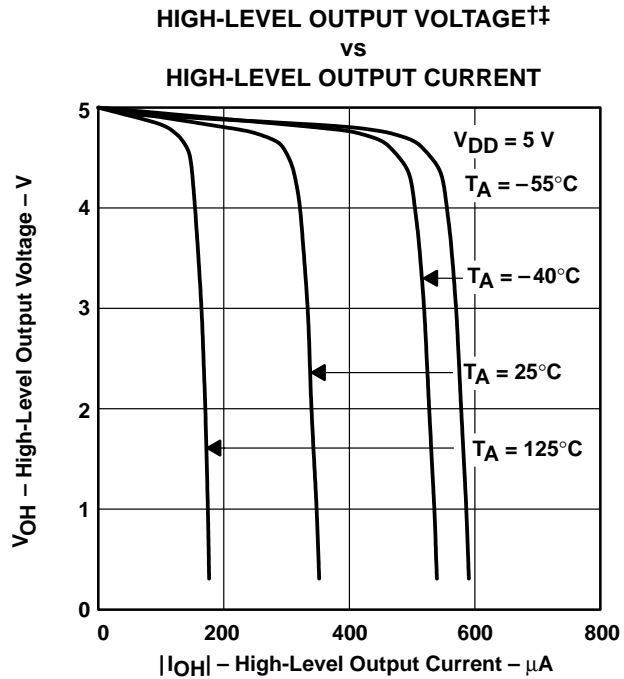

**Figure 15**

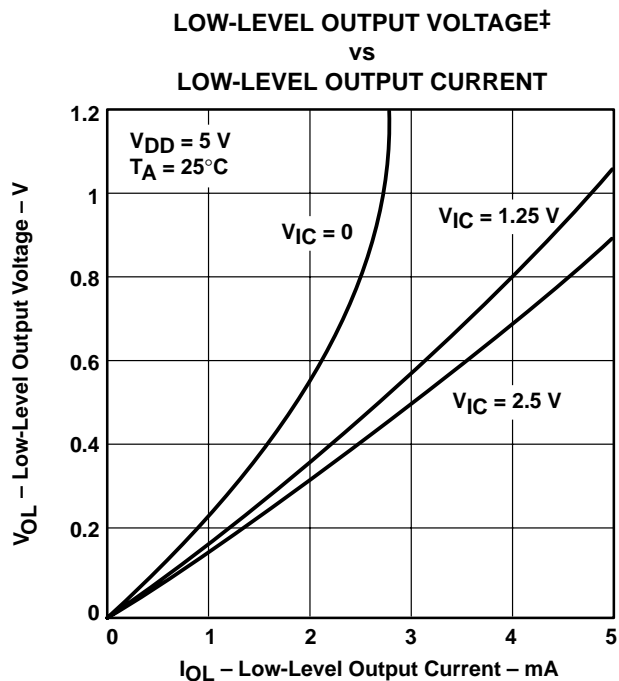

**Figure 16**

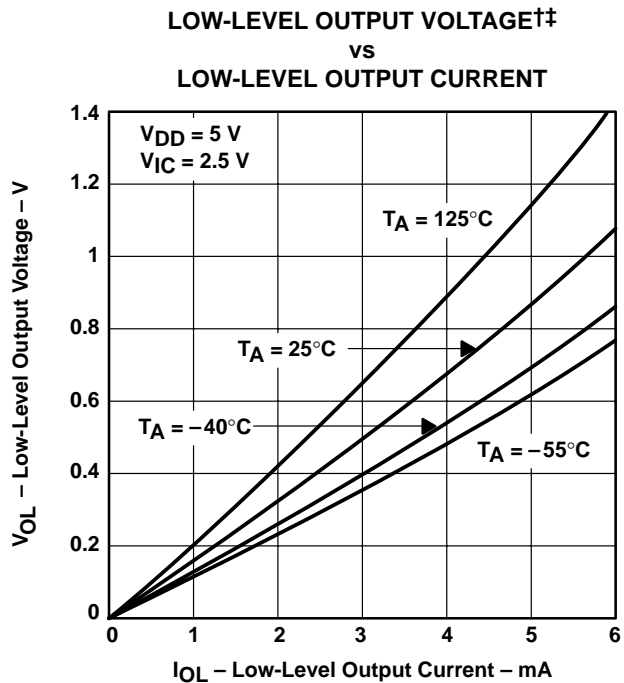

**Figure 17**

† Data at high and low temperatures are applicable only within the rated operating free-air temperature ranges of the various devices.  
 ‡ For curves where  $V_{DD} = 5\text{ V}$ , all loads are referenced to 2.5 V.

TYPICAL CHARACTERISTICS

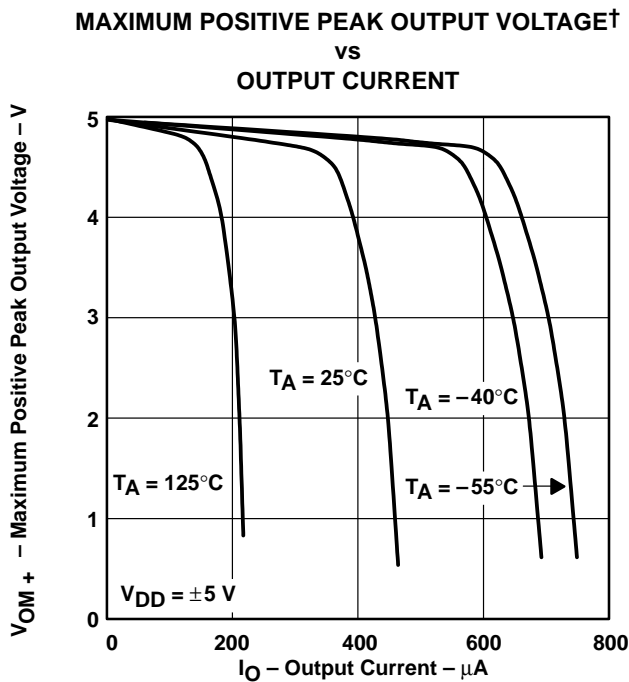

Figure 18

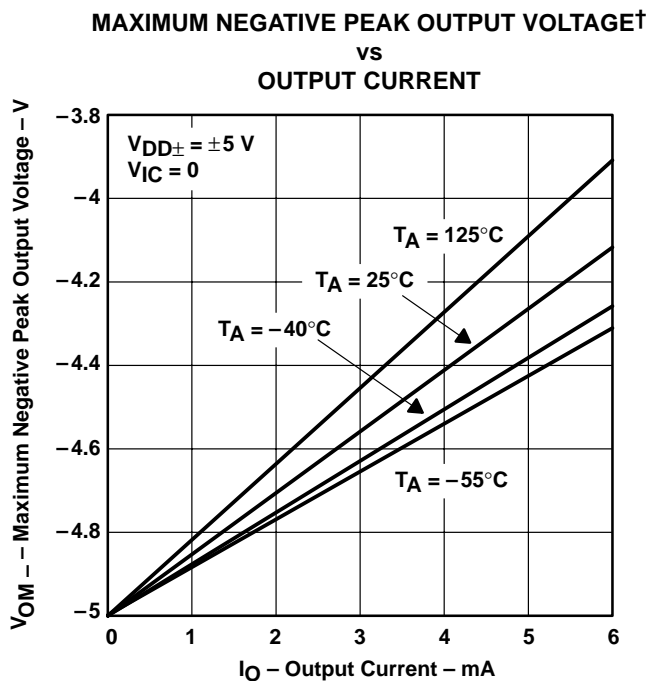

Figure 19

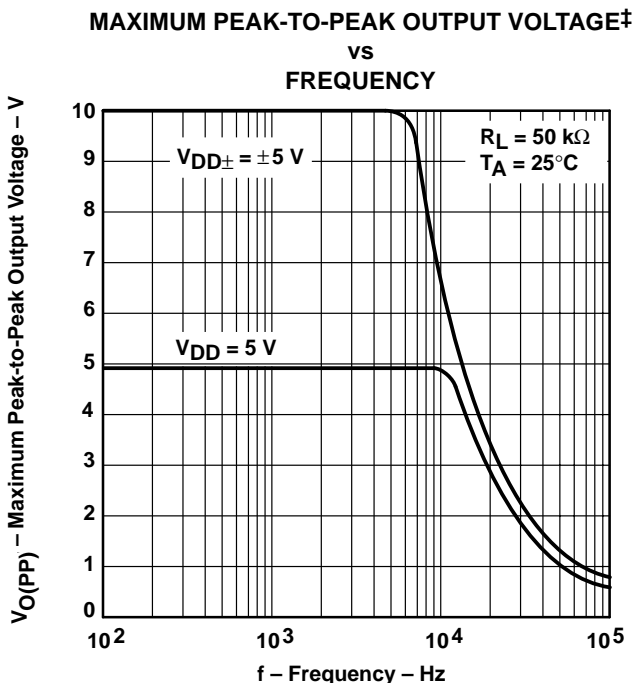

Figure 20

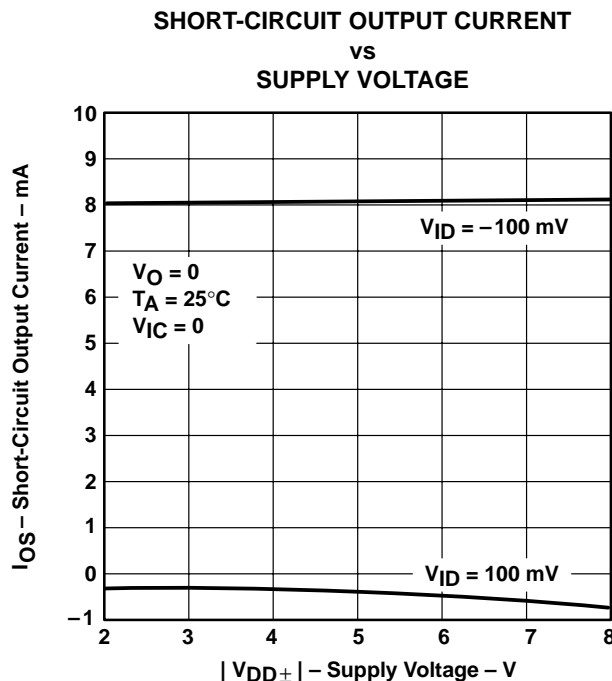

Figure 21

† Data at high and low temperatures are applicable only within the rated operating free-air temperature ranges of the various devices.  
 ‡ For curves where  $V_{DD} = 5\text{ V}$ , all loads are referenced to 2.5 V.

TYPICAL CHARACTERISTICS



Figure 22

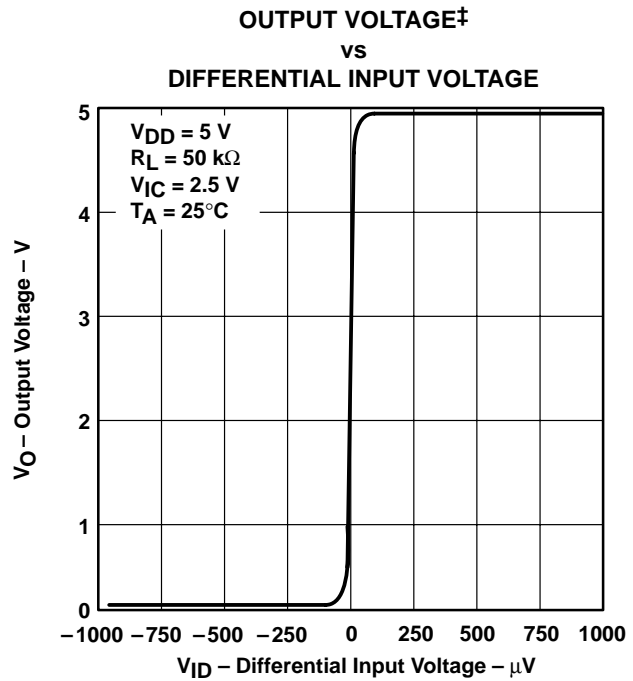

Figure 23

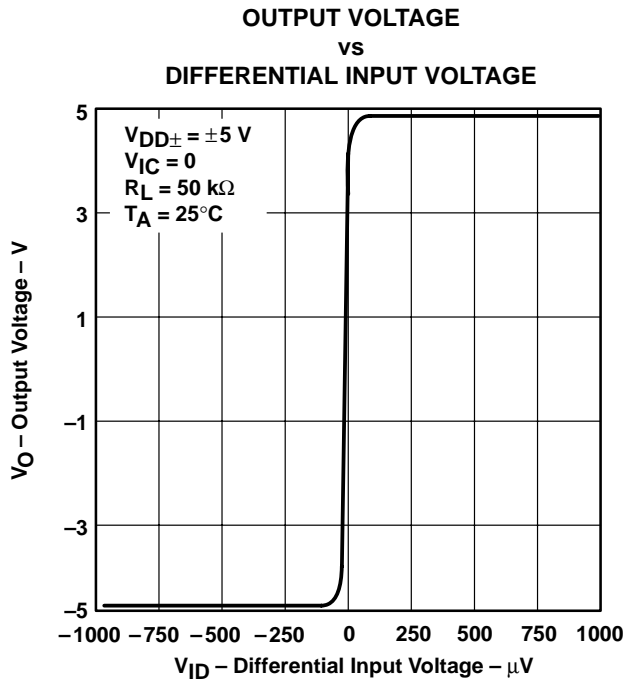

Figure 24

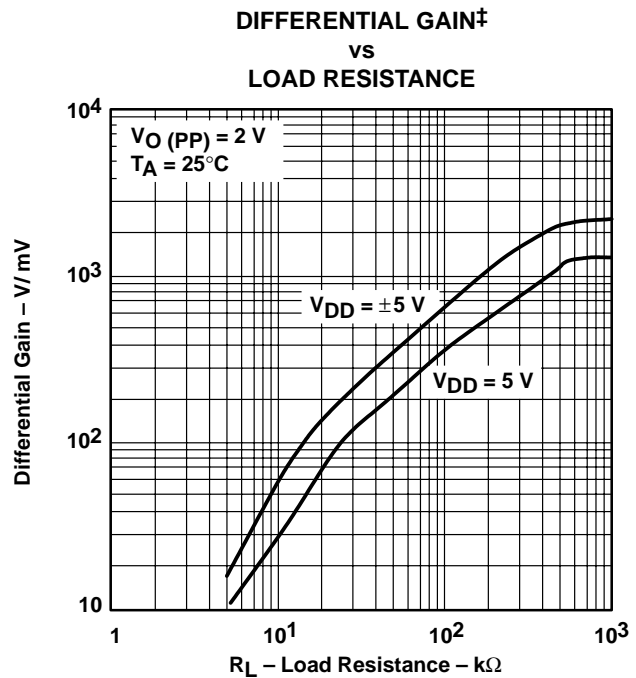

Figure 25

† Data at high and low temperatures are applicable only within the rated operating free-air temperature ranges of the various devices.

‡ For curves where  $V_{DD} = 5$  V, all loads are referenced to 2.5 V.

TYPICAL CHARACTERISTICS

LARGE-SIGNAL DIFFERENTIAL VOLTAGE  
 AMPLIFICATION AND PHASE MARGIN†  
 VS  
 FREQUENCY



Figure 26

LARGE-SIGNAL DIFFERENTIAL VOLTAGE  
 AMPLIFICATION AND PHASE MARGIN  
 VS  
 FREQUENCY

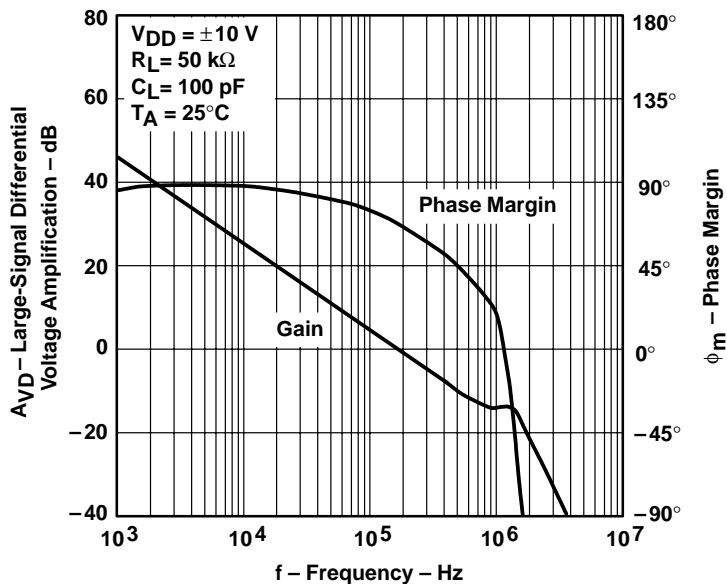

Figure 27

† For curves where  $V_{DD} = 5\text{ V}$ , all loads are referenced to 2.5 V.

**TLC225x, TLC225xA**  
**Advanced LinCMOS™ RAIL-TO-RAIL**  
**VERY LOW-POWER OPERATIONAL AMPLIFIERS**

SLOS176D – FEBRUARY 1997 – REVISED MARCH 2001

**TYPICAL CHARACTERISTICS**

**LARGE-SIGNAL DIFFERENTIAL VOLTAGE AMPLIFICATION†‡**  
**vs**  
**FREE-AIR TEMPERATURE**

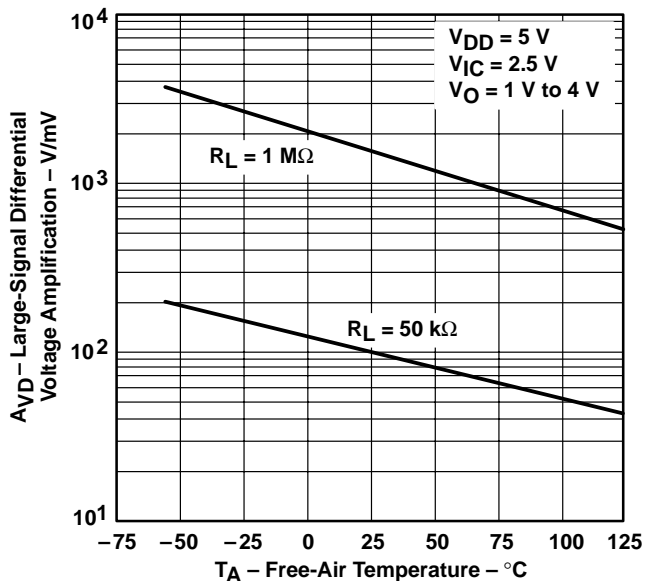

**Figure 28**

**LARGE-SIGNAL DIFFERENTIAL VOLTAGE AMPLIFICATION†**  
**vs**  
**FREE-AIR TEMPERATURE**

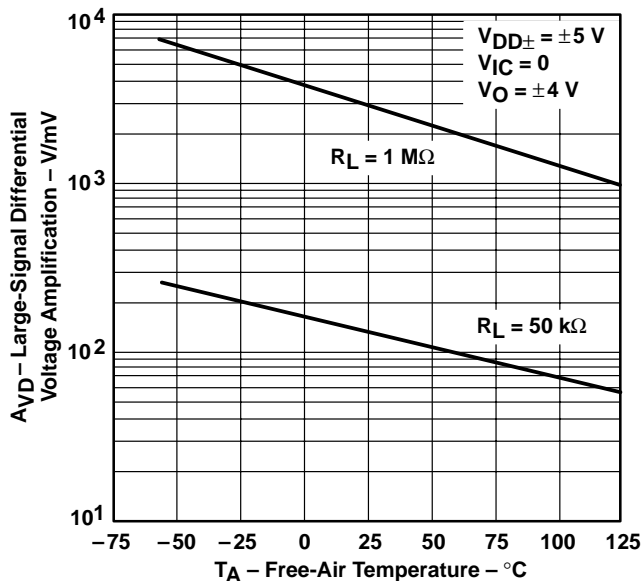

**Figure 29**

**OUTPUT IMPEDANCE‡**  
**vs**  
**FREQUENCY**

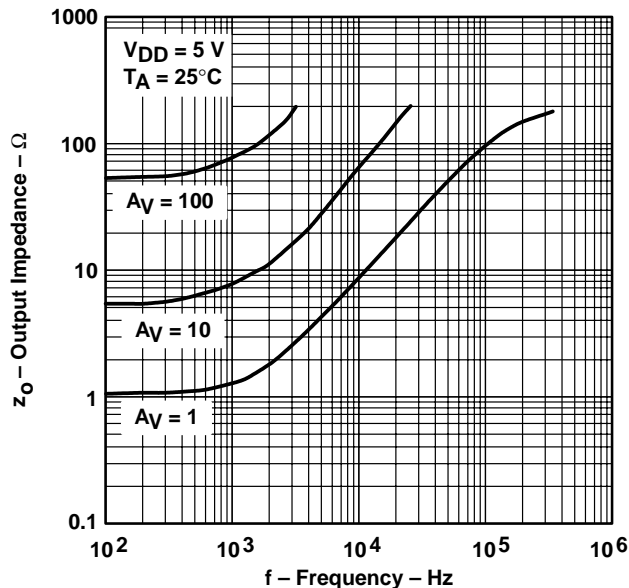

**Figure 30**

**OUTPUT IMPEDANCE**  
**vs**  
**FREQUENCY**

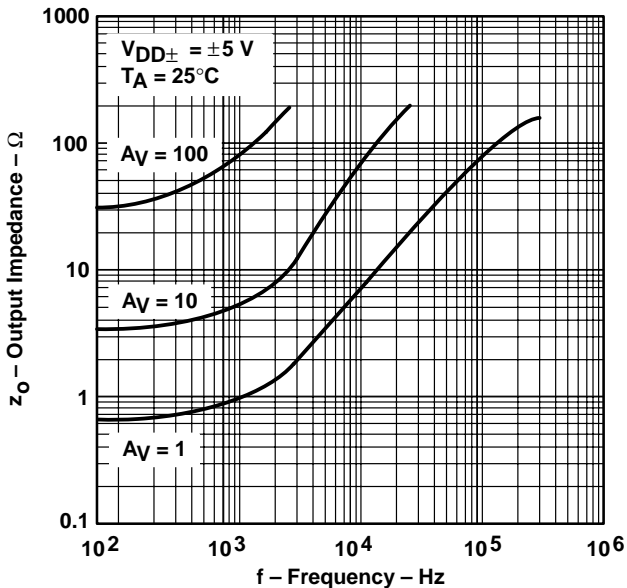

**Figure 31**

† Data at high and low temperatures are applicable only within the rated operating free-air temperature ranges of the various devices.

‡ For curves where  $V_{DD} = 5V$ , all loads are referenced to 2.5V.



TYPICAL CHARACTERISTICS



Figure 32

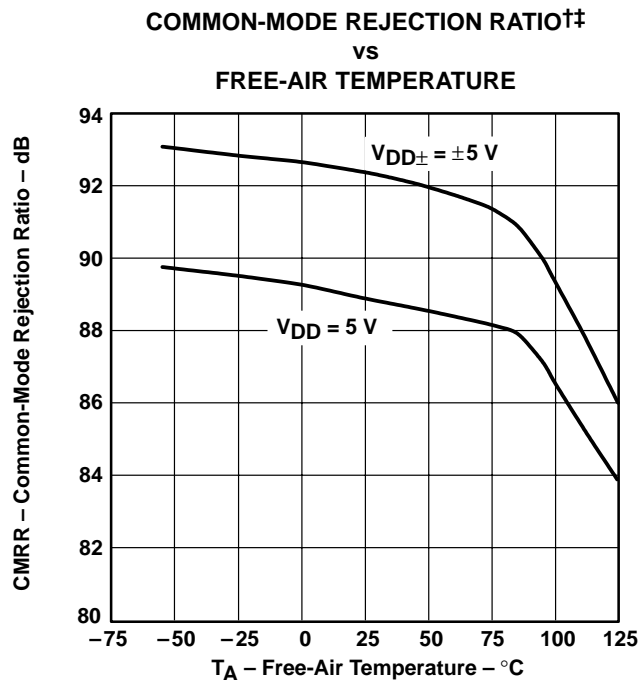

Figure 33



Figure 34

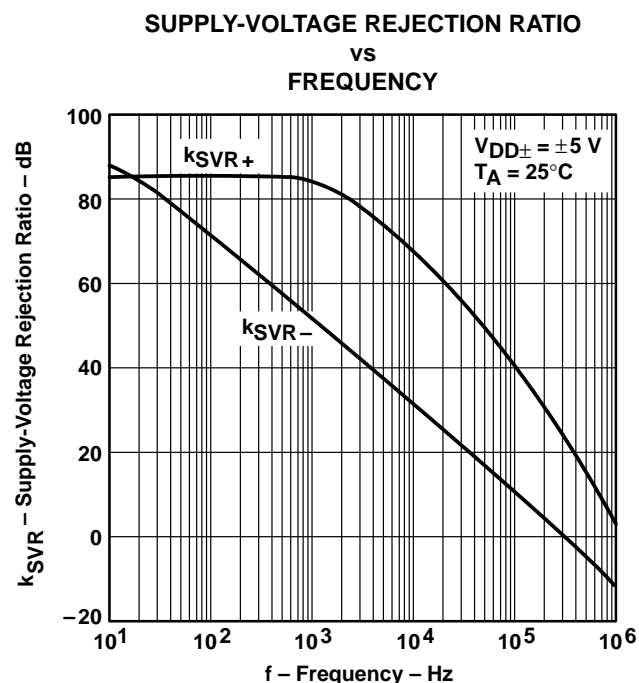
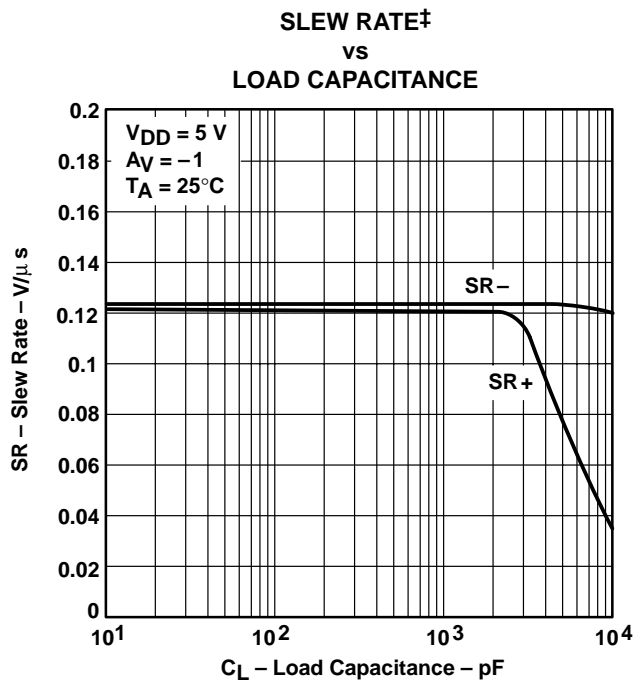
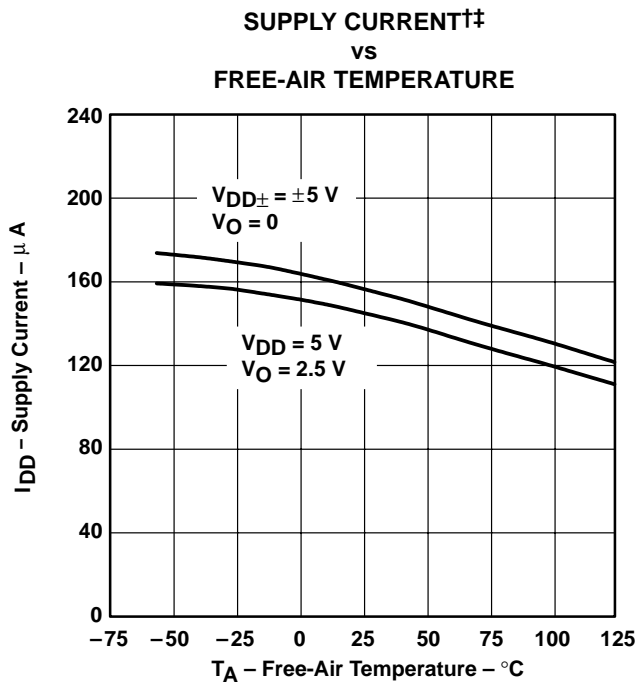
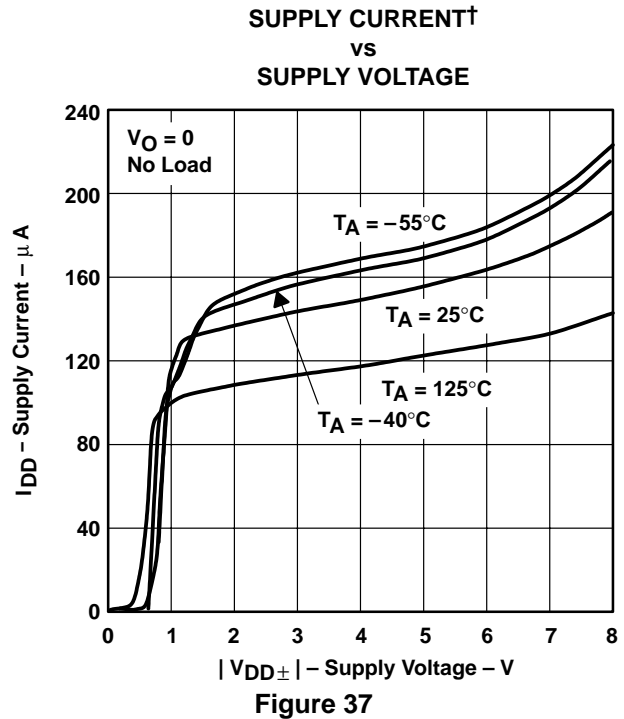
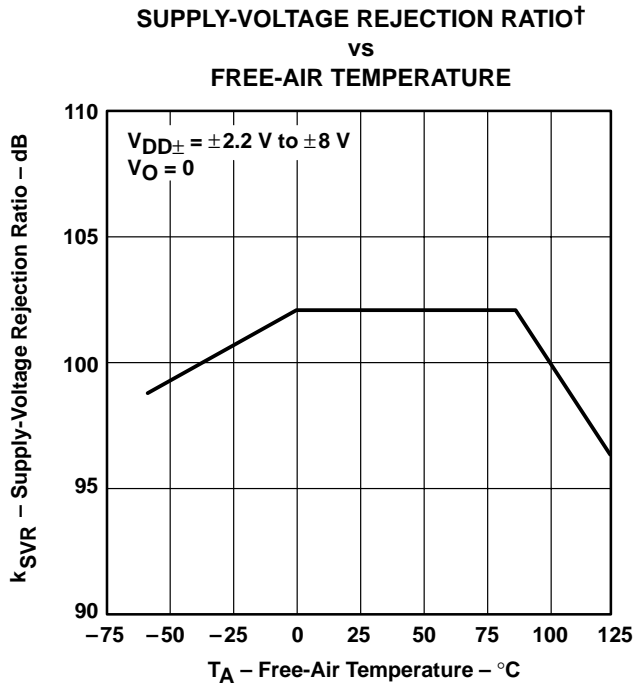

Figure 35

† For curves where  $V_{DD} = 5\text{ V}$ , all loads are referenced to 2.5 V.

†† Data at high and low temperatures are applicable only within the rated operating free-air temperature ranges of the various devices.

TYPICAL CHARACTERISTICS



† Data at high and low temperatures are applicable only within the rated operating free-air temperature ranges of the various devices.

‡ For curves where  $V_{DD} = 5\text{ V}$ , all loads are referenced to 2.5 V.



TYPICAL CHARACTERISTICS

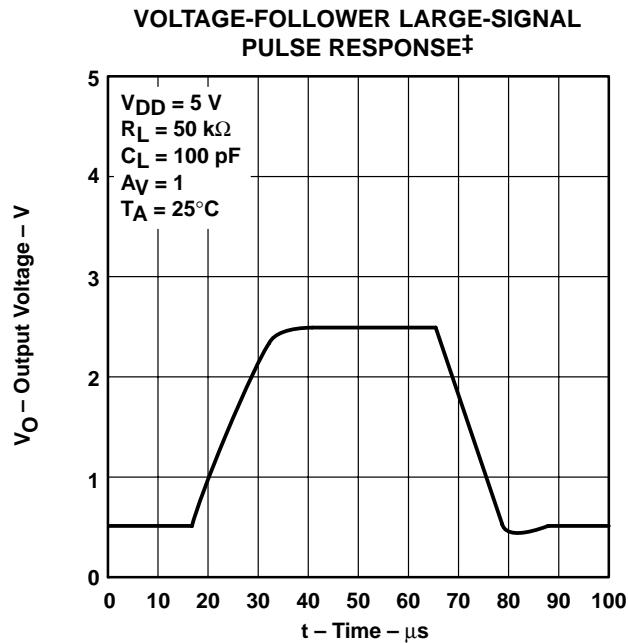
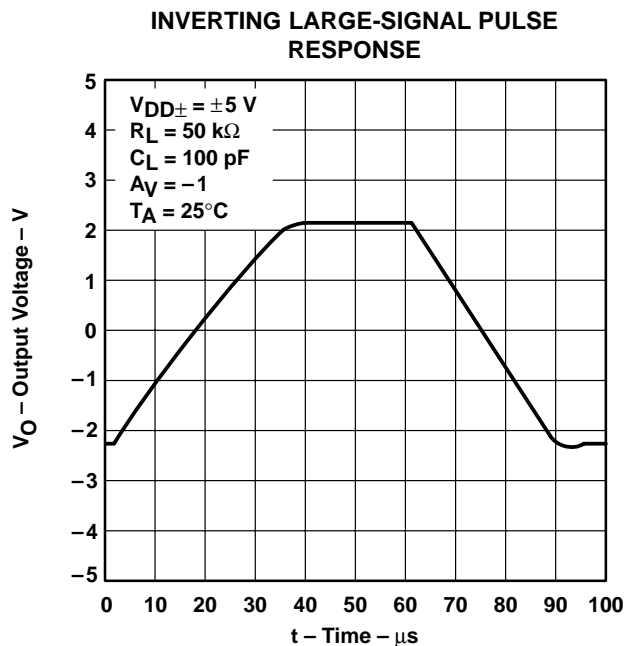
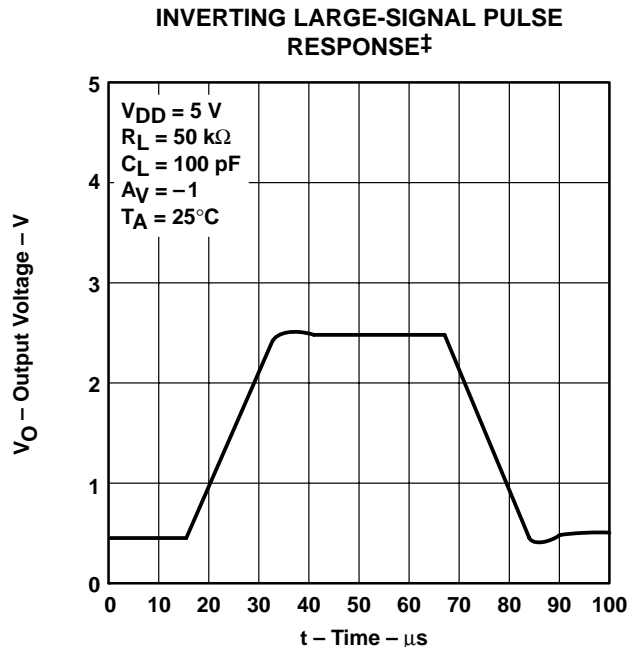
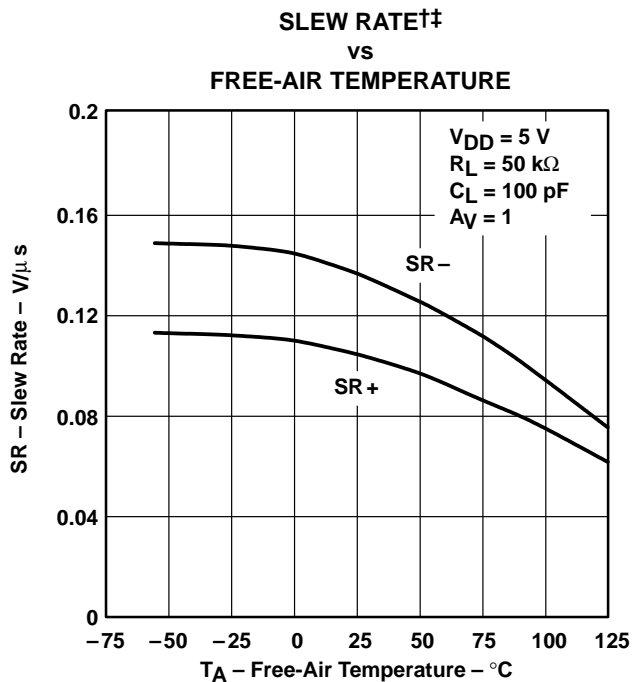

† Data at high and low temperatures are applicable only within the rated operating free-air temperature ranges of the various devices.

‡ For curves where  $V_{DD} = 5\text{ V}$ , all loads are referenced to 2.5 V.

TYPICAL CHARACTERISTICS

VOLTAGE-FOLLOWER LARGE-SIGNAL PULSE RESPONSE

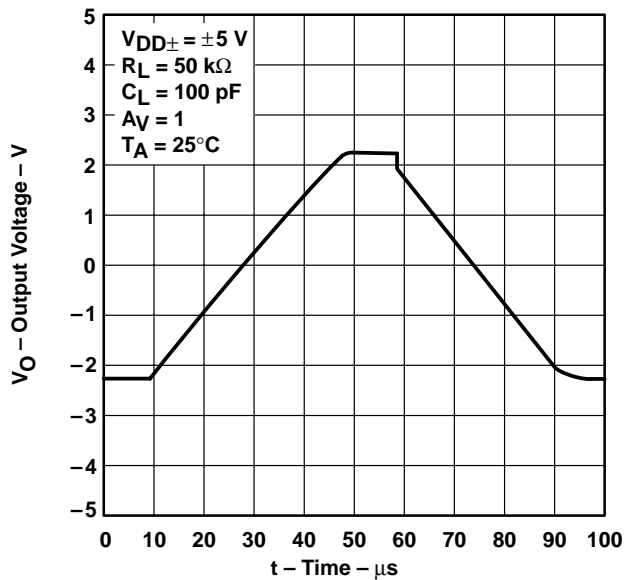

Figure 44

INVERTING SMALL-SIGNAL PULSE RESPONSE†

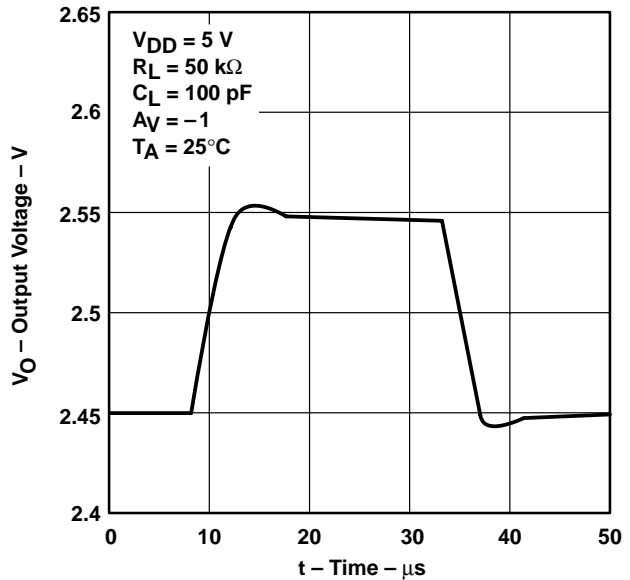

Figure 45

INVERTING SMALL-SIGNAL PULSE RESPONSE



Figure 46

VOLTAGE-FOLLOWER SMALL-SIGNAL PULSE RESPONSE†

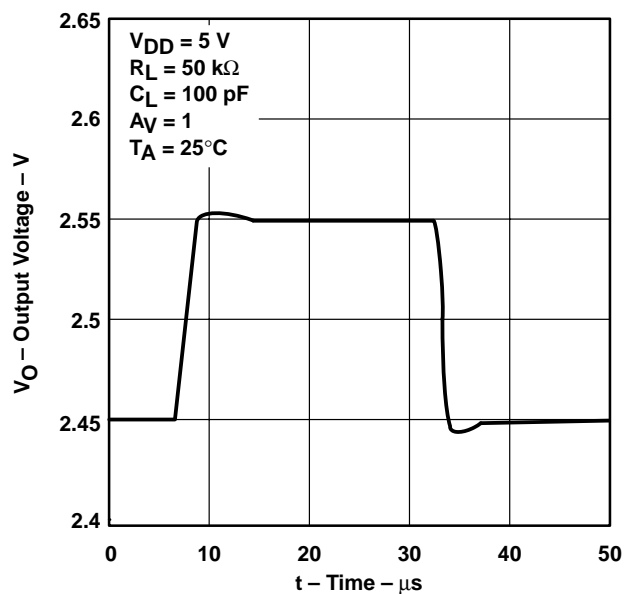

Figure 47

† For curves where  $V_{DD} = 5$  V, all loads are referenced to 2.5 V.

TYPICAL CHARACTERISTICS



Figure 48

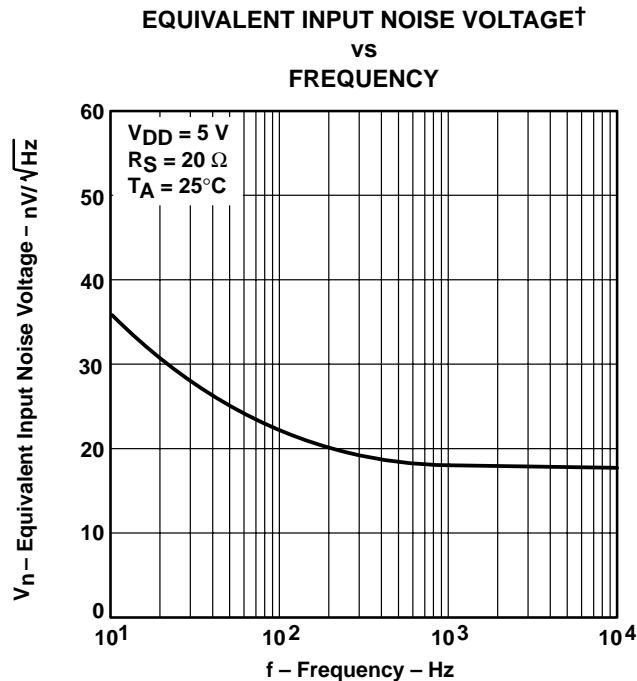

Figure 49



Figure 50

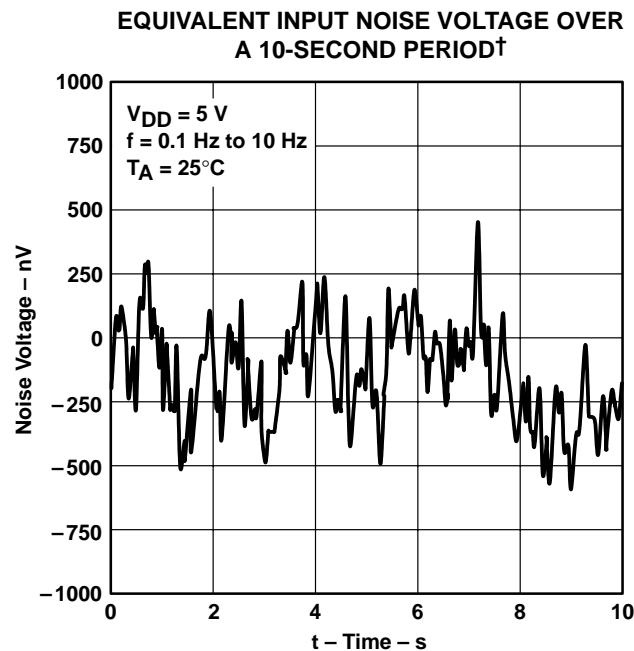
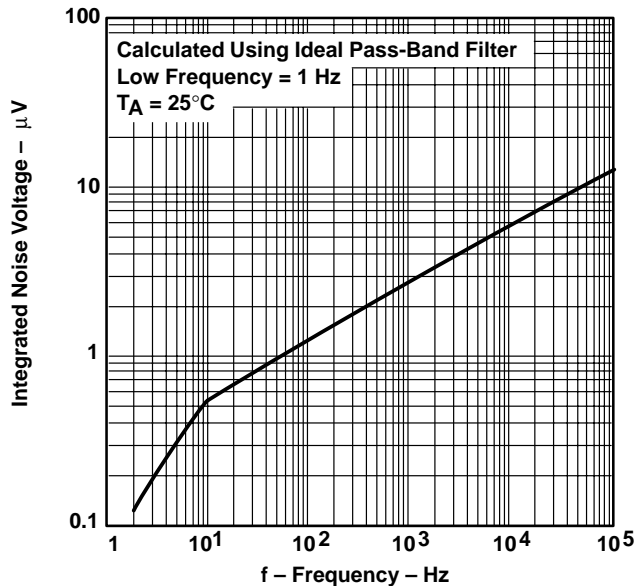

Figure 51

† For curves where  $V_{DD} = 5 \text{ V}$ , all loads are referenced to 2.5 V.

**TYPICAL CHARACTERISTICS**

**INTEGRATED NOISE VOLTAGE  
 VS  
 FREQUENCY**



**Figure 52**

**TOTAL HARMONIC DISTORTION PLUS NOISE†  
 VS  
 FREQUENCY**

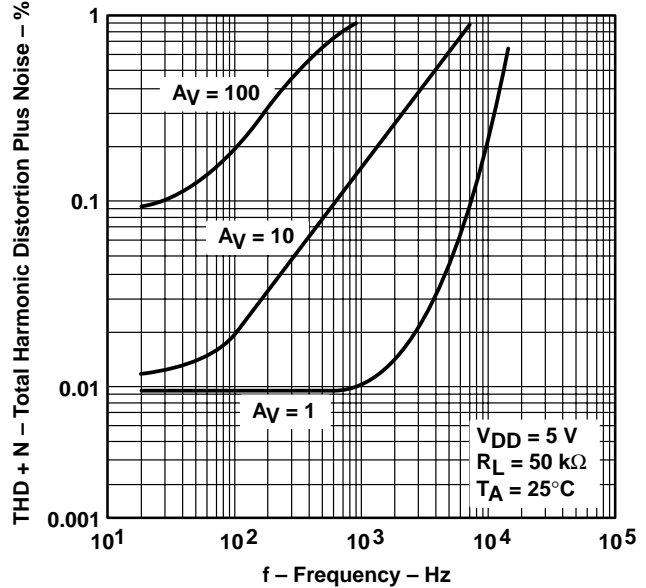

**Figure 53**

**GAIN-BANDWIDTH PRODUCT‡  
 VS  
 FREE-AIR TEMPERATURE**

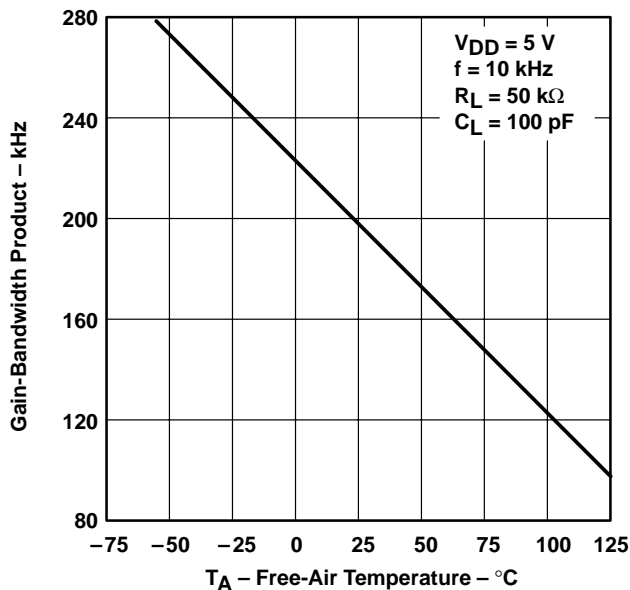

**Figure 54**

**GAIN-BANDWIDTH PRODUCT  
 VS  
 SUPPLY VOLTAGE**

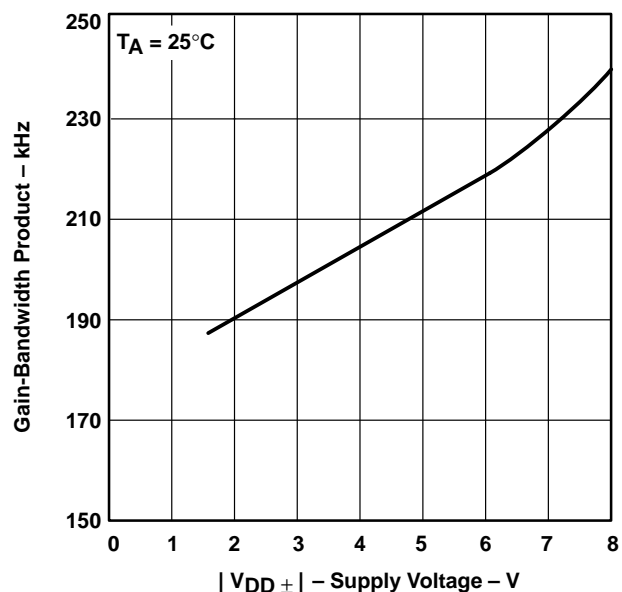
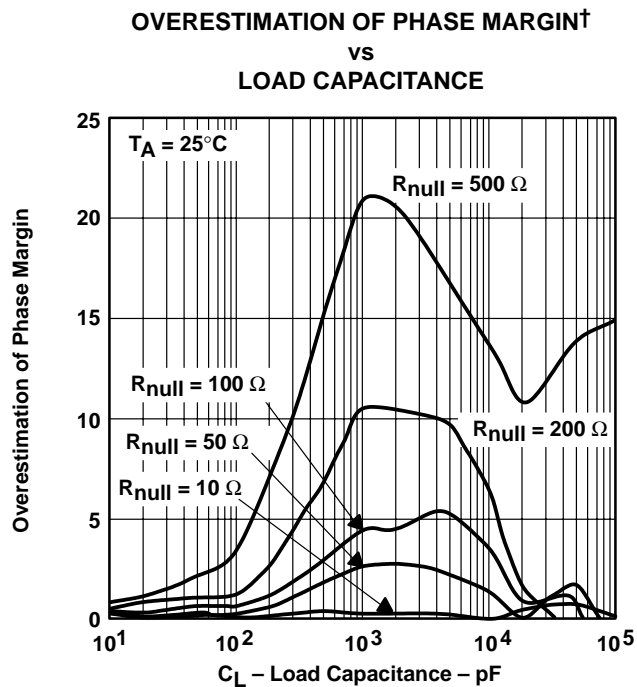
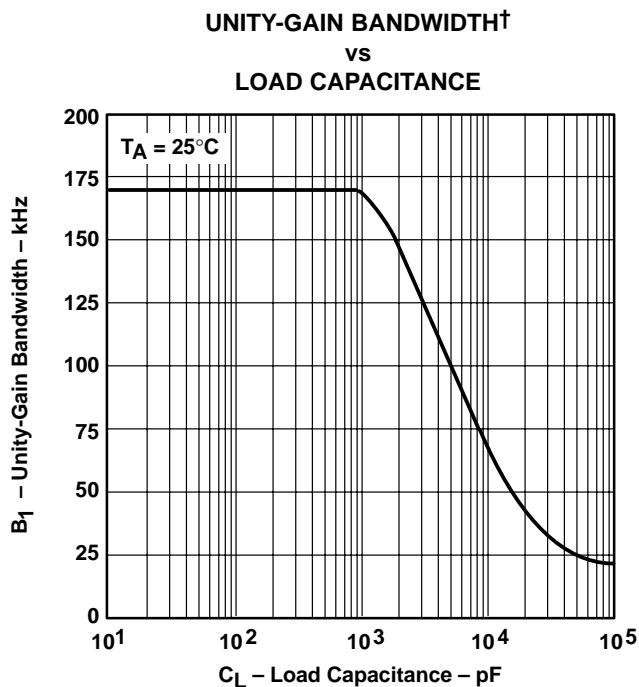
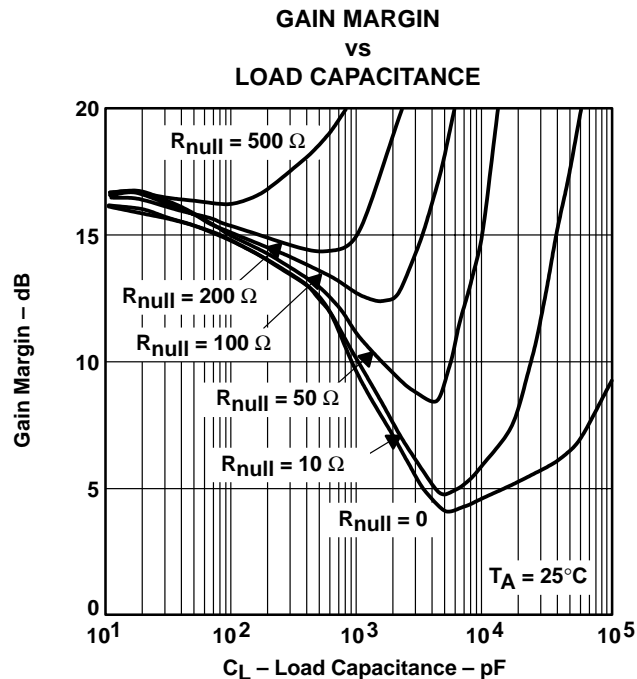

**Figure 55**

† For curves where  $V_{DD} = 5\text{ V}$ , all loads are referenced to  $2.5\text{ V}$ .

‡ Data at high and low temperatures are applicable only within the rated operating free-air temperature ranges of the various devices.

TYPICAL CHARACTERISTICS



† See application information

**APPLICATION INFORMATION**

**driving large capacitive loads**

The TLC225x is designed to drive larger capacitive loads than most CMOS operational amplifiers. Figure 56 and Figure 57 illustrate its ability to drive loads up to 1000 pF while maintaining good gain and phase margins ( $R_{null} = 0$ ).

A smaller series resistor ( $R_{null}$ ) at the output of the device (see Figure 60) improves the gain and phase margins when driving large capacitive loads. Figure 56 and Figure 57 show the effects of adding series resistances of 10  $\Omega$ , 50  $\Omega$ , 100  $\Omega$ , 200  $\Omega$ , and 500  $\Omega$ . The addition of this series resistor has two effects: the first is that it adds a zero to the transfer function and the second is that it reduces the frequency of the pole associated with the output load in the transfer function.

The zero introduced to the transfer function is equal to the series resistance times the load capacitance. To calculate the improvement in phase margin, equation 1 can be used.

$$\Delta\phi_{m1} = \tan^{-1} \left( 2 \times \pi \times \text{UGBW} \times R_{null} \times C_L \right) \tag{1}$$

Where :

- $\Delta\phi_{m1}$  = Improvement in phase margin
- UGBW = Unity-gain bandwidth frequency
- $R_{null}$  = Output series resistance
- $C_L$  = Load capacitance

The unity-gain bandwidth (UGBW) frequency decreases as the capacitive load increases (see Figure 58). To use equation 1, UGBW must be approximated from Figure 58.

Using equation 1 alone overestimates the improvement in phase margin, as illustrated in Figure 59. The overestimation is caused by the decrease in the frequency of the pole associated with the load, thus providing additional phase shift and reducing the overall improvement in phase margin.

Using Figure 60, with equation 1 enables the designer to choose the appropriate output series resistance to optimize the design of circuits driving large capacitance loads.

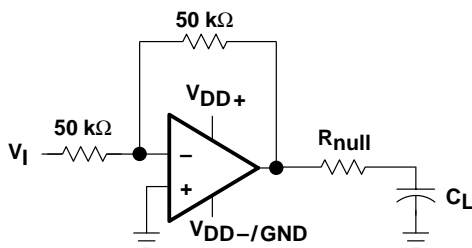

**Figure 60. Series-Resistance Circuit**

## APPLICATION INFORMATION

### macromodel information

Macromodel information provided was derived using MicroSim *Parts*™, the model generation software used with MicroSim *PSpice*™. The Boyle macromodel (see Note 5) and subcircuit in Figure 61 are generated using the TLC225x typical electrical and operating characteristics at  $T_A = 25^\circ\text{C}$ . Using this information, output simulations of the following key parameters can be generated to a tolerance of 20% (in most cases):

- Maximum positive output voltage swing
- Maximum negative output voltage swing
- Slew rate
- Quiescent power dissipation
- Input bias current
- Open-loop voltage amplification
- Unity-gain frequency
- Common-mode rejection ratio
- Phase margin
- DC output resistance
- AC output resistance
- Short-circuit output current limit

NOTE 5: G. R. Boyle, B. M. Cohn, D. O. Pederson, and J. E. Solomon, "Macromodeling of Integrated Circuit Operational Amplifiers", *IEEE Journal of Solid-State Circuits*, SC-9, 353 (1974).

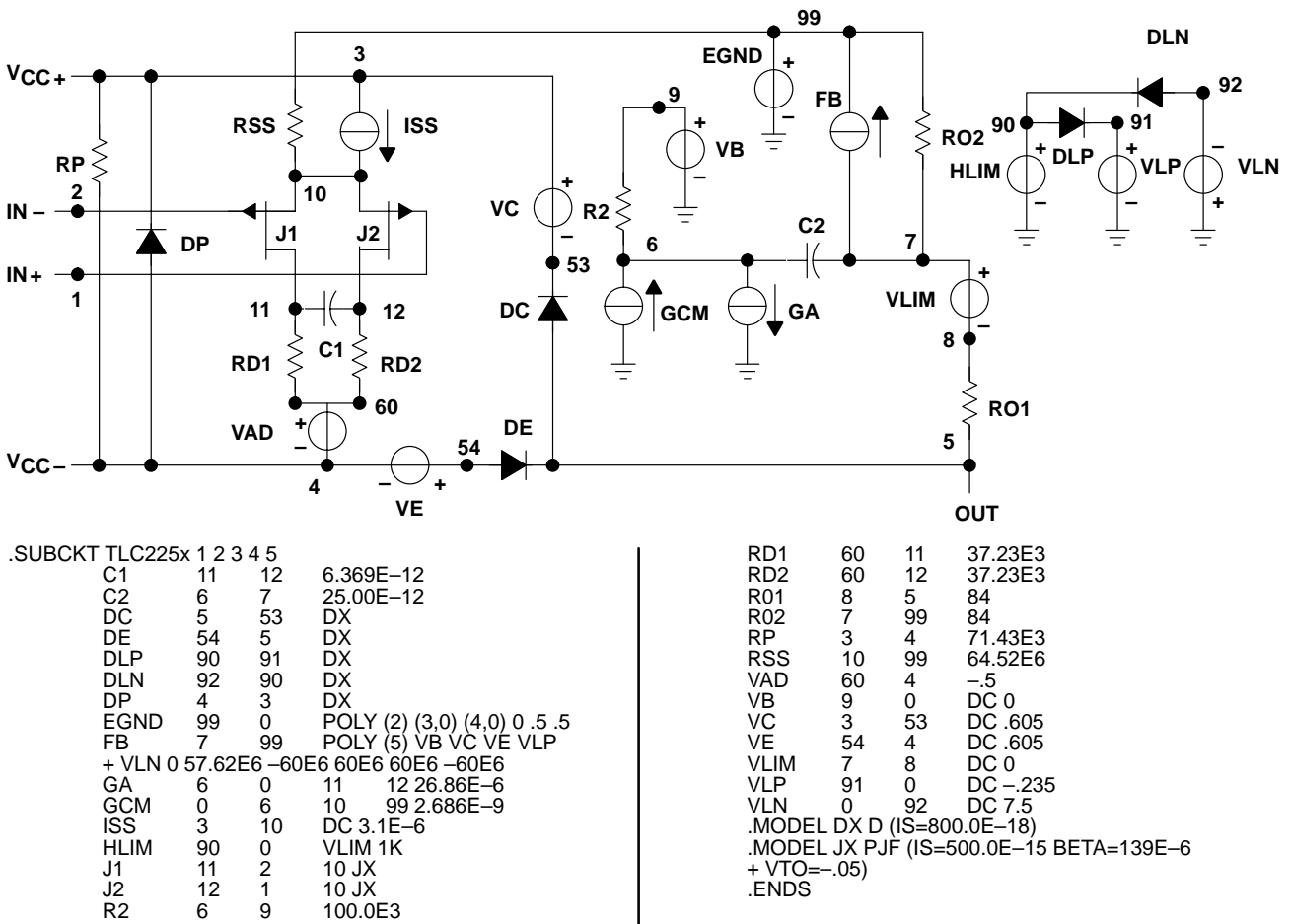

**Figure 61. Boyle Macromodel and Subcircuit**

*PSpice* and *Parts* are trademarks of MicroSim Corporation.

**PACKAGING INFORMATION**

Orderable Device	Status (1)	Package Type	Package Drawing	Pins	Package Qty	Eco Plan (2)	Lead finish/ Ball material (6)	MSL Peak Temp (3)	Op Temp (°C)	Device Marking (4/5)	Samples
5962-9564001Q2A	ACTIVE	LCCC	FK	20	1	Non-RoHS & Green	SNPB	N / A for Pkg Type	-55 to 125	5962-9564001Q2A TLC2252 MFKB	<a href="#">Samples</a>
5962-9564001QHA	ACTIVE	CFP	U	10	1	Non-RoHS & Green	SNPB	N / A for Pkg Type	-55 to 125	9564001QHA TLC2252M	<a href="#">Samples</a>
5962-9564001QPA	ACTIVE	CDIP	JG	8	1	Non-RoHS & Green	SNPB	N / A for Pkg Type	-55 to 125	9564001QPA TLC2252M	<a href="#">Samples</a>
5962-9564002Q2A	ACTIVE	LCCC	FK	20	1	Non-RoHS & Green	SNPB	N / A for Pkg Type	-55 to 125	5962-9564002Q2A TLC2254 MFKB	<a href="#">Samples</a>
5962-9564002QDA	ACTIVE	CFP	W	14	1	Non-RoHS & Green	SNPB	N / A for Pkg Type	-55 to 125	5962-9564002QDA TLC2254MWB	<a href="#">Samples</a>
5962-9564003NXD	ACTIVE	SOIC	D	8	2500	RoHS & Green	NIPDAU	Level-1-260C-UNLIM	-55 to 125	Q2252A	<a href="#">Samples</a>
5962-9564003NXDR	ACTIVE	SOIC	D	8	2500	RoHS & Green	NIPDAU	Level-1-260C-UNLIM	-55 to 125	Q2252A	<a href="#">Samples</a>
5962-9564003Q2A	ACTIVE	LCCC	FK	20	1	Non-RoHS & Green	SNPB	N / A for Pkg Type	-55 to 125	5962-9564003Q2A TLC2252 AMFKB	<a href="#">Samples</a>
5962-9564003QHA	ACTIVE	CFP	U	10	1	Non-RoHS & Green	SNPB	N / A for Pkg Type	-55 to 125	9564003QHA TLC2252AM	<a href="#">Samples</a>
5962-9564003QPA	ACTIVE	CDIP	JG	8	1	Non-RoHS & Green	SNPB	N / A for Pkg Type	-55 to 125	9564003QPA TLC2252AM	<a href="#">Samples</a>
5962-9564004Q2A	ACTIVE	LCCC	FK	20	1	Non-RoHS & Green	SNPB	N / A for Pkg Type	-55 to 125	5962-9564004Q2A TLC2254 AMFKB	<a href="#">Samples</a>
5962-9564004QDA	ACTIVE	CFP	W	14	1	Non-RoHS & Green	SNPB	N / A for Pkg Type	-55 to 125	5962-9564004QDA TLC2254AMWB	<a href="#">Samples</a>
TLC2252AID	ACTIVE	SOIC	D	8	75	RoHS & Green	NIPDAU	Level-1-260C-UNLIM		2252AI	<a href="#">Samples</a>



Orderable Device	Status (1)	Package Type	Package Drawing	Pins	Package Qty	Eco Plan (2)	Lead finish/ Ball material (6)	MSL Peak Temp (3)	Op Temp (°C)	Device Marking (4/5)	Samples
TLC2252AIDG4	ACTIVE	SOIC	D	8	75	RoHS & Green	NIPDAU	Level-1-260C-UNLIM		2252AI	<a href="#">Samples</a>
TLC2252AIDR	ACTIVE	SOIC	D	8	2500	RoHS & Green	NIPDAU	Level-1-260C-UNLIM		2252AI	<a href="#">Samples</a>
TLC2252AIDRG4	ACTIVE	SOIC	D	8	2500	RoHS & Green	NIPDAU	Level-1-260C-UNLIM		2252AI	<a href="#">Samples</a>
TLC2252AIP	ACTIVE	PDIP	P	8	50	RoHS & Green	NIPDAU	N / A for Pkg Type		TLC2252AI	<a href="#">Samples</a>
TLC2252AIPW	ACTIVE	TSSOP	PW	8	150	RoHS & Green	NIPDAU	Level-1-260C-UNLIM		Y2252A	<a href="#">Samples</a>
TLC2252AIPWR	ACTIVE	TSSOP	PW	8	2000	RoHS & Green	NIPDAU	Level-1-260C-UNLIM		Y2252A	<a href="#">Samples</a>
TLC2252AMFKB	ACTIVE	LCCC	FK	20	1	Non-RoHS & Green	SNPB	N / A for Pkg Type	-55 to 125	5962- 9564003Q2A TLC2252 AMFKB	<a href="#">Samples</a>
TLC2252AMJGB	ACTIVE	CDIP	JG	8	1	Non-RoHS & Green	SNPB	N / A for Pkg Type	-55 to 125	9564003QPA TLC2252AM	<a href="#">Samples</a>
TLC2252AMUB	ACTIVE	CFP	U	10	1	Non-RoHS & Green	SNPB	N / A for Pkg Type	-55 to 125	9564003QHA TLC2252AM	<a href="#">Samples</a>
TLC2252AQDR	ACTIVE	SOIC	D	8	2500	RoHS & Green	NIPDAU	Level-1-260C-UNLIM	-40 to 125	C2252A	<a href="#">Samples</a>
TLC2252AQDRG4	ACTIVE	SOIC	D	8	2500	RoHS & Green	NIPDAU	Level-1-260C-UNLIM		C2252A	<a href="#">Samples</a>
TLC2252CD	ACTIVE	SOIC	D	8	75	RoHS & Green	NIPDAU	Level-1-260C-UNLIM	0 to 70	2252C	<a href="#">Samples</a>
TLC2252CDG4	ACTIVE	SOIC	D	8	75	RoHS & Green	NIPDAU	Level-1-260C-UNLIM	0 to 70	2252C	<a href="#">Samples</a>
TLC2252CDR	ACTIVE	SOIC	D	8	2500	RoHS & Green	NIPDAU	Level-1-260C-UNLIM	0 to 70	2252C	<a href="#">Samples</a>
TLC2252CP	ACTIVE	PDIP	P	8	50	RoHS & Green	NIPDAU	N / A for Pkg Type	0 to 70	TLC2252CP	<a href="#">Samples</a>
TLC2252CPW	ACTIVE	TSSOP	PW	8	150	RoHS & Green	NIPDAU	Level-1-260C-UNLIM	0 to 70	P2252	<a href="#">Samples</a>
TLC2252CPWR	ACTIVE	TSSOP	PW	8	2000	RoHS & Green	NIPDAU	Level-1-260C-UNLIM	0 to 70	P2252	<a href="#">Samples</a>
TLC2252ID	ACTIVE	SOIC	D	8	75	RoHS & Green	NIPDAU	Level-1-260C-UNLIM	-40 to 125	2252I	<a href="#">Samples</a>
TLC2252IDG4	ACTIVE	SOIC	D	8	75	RoHS & Green	NIPDAU	Level-1-260C-UNLIM	-40 to 125	2252I	<a href="#">Samples</a>

Orderable Device	Status (1)	Package Type	Package Drawing	Pins	Package Qty	Eco Plan (2)	Lead finish/ Ball material (6)	MSL Peak Temp (3)	Op Temp (°C)	Device Marking (4/5)	Samples
TLC2252IDR	ACTIVE	SOIC	D	8	2500	RoHS & Green	NIPDAU	Level-1-260C-UNLIM	-40 to 125	2252I	<a href="#">Samples</a>
TLC2252IP	ACTIVE	PDIP	P	8	50	RoHS & Green	NIPDAU	N / A for Pkg Type	-40 to 125	TLC2252IP	<a href="#">Samples</a>
TLC2252MFKB	ACTIVE	LCCC	FK	20	1	Non-RoHS & Green	SNPB	N / A for Pkg Type	-55 to 125	5962-9564001Q2A TLC2252 MFKB	<a href="#">Samples</a>
TLC2252MJGB	ACTIVE	CDIP	JG	8	1	Non-RoHS & Green	SNPB	N / A for Pkg Type	-55 to 125	9564001QPA TLC2252M	<a href="#">Samples</a>
TLC2252MUB	ACTIVE	CFP	U	10	1	Non-RoHS & Green	SNPB	N / A for Pkg Type	-55 to 125	9564001QHA TLC2252M	<a href="#">Samples</a>
TLC2254AID	ACTIVE	SOIC	D	14	50	RoHS & Green	NIPDAU	Level-1-260C-UNLIM		2254AI	<a href="#">Samples</a>
TLC2254AIDG4	ACTIVE	SOIC	D	14	50	RoHS & Green	NIPDAU	Level-1-260C-UNLIM		2254AI	<a href="#">Samples</a>
TLC2254AIDR	ACTIVE	SOIC	D	14	2500	RoHS & Green	NIPDAU	Level-1-260C-UNLIM		2254AI	<a href="#">Samples</a>
TLC2254AIDRG4	ACTIVE	SOIC	D	14	2500	RoHS & Green	NIPDAU	Level-1-260C-UNLIM		2254AI	<a href="#">Samples</a>
TLC2254AIN	ACTIVE	PDIP	N	14	25	RoHS & Green	NIPDAU	N / A for Pkg Type		TLC2254AIN	<a href="#">Samples</a>
TLC2254AIPW	ACTIVE	TSSOP	PW	14	90	RoHS & Green	NIPDAU	Level-1-260C-UNLIM		Y2254A	<a href="#">Samples</a>
TLC2254AIPWR	ACTIVE	TSSOP	PW	14	2000	RoHS & Green	NIPDAU	Level-1-260C-UNLIM		Y2254A	<a href="#">Samples</a>
TLC2254AIPWRG4	ACTIVE	TSSOP	PW	14	2000	RoHS & Green	NIPDAU	Level-1-260C-UNLIM		Y2254A	<a href="#">Samples</a>
TLC2254AMFKB	ACTIVE	LCCC	FK	20	1	Non-RoHS & Green	SNPB	N / A for Pkg Type	-55 to 125	5962-9564004Q2A TLC2254 AMFKB	<a href="#">Samples</a>
TLC2254AMWB	ACTIVE	CFP	W	14	1	Non-RoHS & Green	SNPB	N / A for Pkg Type	-55 to 125	5962-9564004QD A TLC2254AMWB	<a href="#">Samples</a>
TLC2254AQD	ACTIVE	SOIC	D	14	50	RoHS & Green	NIPDAU	Level-1-260C-UNLIM	-40 to 125	TLC2254A	<a href="#">Samples</a>
TLC2254AQDR	ACTIVE	SOIC	D	14	2500	RoHS & Green	NIPDAU	Level-1-260C-UNLIM	-40 to 125	TLC2254A	<a href="#">Samples</a>

Orderable Device	Status (1)	Package Type	Package Drawing	Pins	Package Qty	Eco Plan (2)	Lead finish/ Ball material (6)	MSL Peak Temp (3)	Op Temp (°C)	Device Marking (4/5)	Samples
TLC2254CD	ACTIVE	SOIC	D	14	50	RoHS & Green	Call TI   NIPDAU	Level-1-260C-UNLIM	0 to 70	TLC2254C	<a href="#">Samples</a>
TLC2254CDG4	ACTIVE	SOIC	D	14	50	RoHS & Green	Call TI	Level-1-260C-UNLIM	0 to 70	TLC2254C	<a href="#">Samples</a>
TLC2254CDR	ACTIVE	SOIC	D	14	2500	RoHS & Green	NIPDAU	Level-1-260C-UNLIM	0 to 70	TLC2254C	<a href="#">Samples</a>
TLC2254CDRG4	ACTIVE	SOIC	D	14	2500	RoHS & Green	NIPDAU	Level-1-260C-UNLIM	0 to 70	TLC2254C	<a href="#">Samples</a>
TLC2254CN	ACTIVE	PDIP	N	14	25	RoHS & Green	NIPDAU	N / A for Pkg Type	0 to 70	TLC2254CN	<a href="#">Samples</a>
TLC2254CPW	ACTIVE	TSSOP	PW	14	90	RoHS & Green	NIPDAU	Level-1-260C-UNLIM	0 to 70	P2254	<a href="#">Samples</a>
TLC2254CPWR	ACTIVE	TSSOP	PW	14	2000	RoHS & Green	NIPDAU	Level-1-260C-UNLIM	0 to 70	P2254	<a href="#">Samples</a>
TLC2254ID	ACTIVE	SOIC	D	14	50	RoHS & Green	NIPDAU	Level-1-260C-UNLIM		TLC2254I	<a href="#">Samples</a>
TLC2254IDG4	ACTIVE	SOIC	D	14	50	RoHS & Green	NIPDAU	Level-1-260C-UNLIM		TLC2254I	<a href="#">Samples</a>
TLC2254IDR	ACTIVE	SOIC	D	14	2500	RoHS & Green	NIPDAU	Level-1-260C-UNLIM		TLC2254I	<a href="#">Samples</a>
TLC2254IDRG4	ACTIVE	SOIC	D	14	2500	RoHS & Green	NIPDAU	Level-1-260C-UNLIM		TLC2254I	<a href="#">Samples</a>
TLC2254IN	ACTIVE	PDIP	N	14	25	RoHS & Green	NIPDAU	N / A for Pkg Type		TLC2254IN	<a href="#">Samples</a>
TLC2254MFKB	ACTIVE	LCCC	FK	20	1	Non-RoHS & Green	SNPB	N / A for Pkg Type	-55 to 125	5962-9564002Q2A TLC2254 MFKB	<a href="#">Samples</a>
TLC2254MWB	ACTIVE	CFP	W	14	1	Non-RoHS & Green	SNPB	N / A for Pkg Type	-55 to 125	5962-9564002QD A TLC2254MWB	<a href="#">Samples</a>

(1) The marketing status values are defined as follows:

**ACTIVE:** Product device recommended for new designs.

**LIFEBUY:** TI has announced that the device will be discontinued, and a lifetime-buy period is in effect.

**NRND:** Not recommended for new designs. Device is in production to support existing customers, but TI does not recommend using this part in a new design.

**PREVIEW:** Device has been announced but is not in production. Samples may or may not be available.

**OBSELETE:** TI has discontinued the production of the device.

(2) **RoHS:** TI defines "RoHS" to mean semiconductor products that are compliant with the current EU RoHS requirements for all 10 RoHS substances, including the requirement that RoHS substance do not exceed 0.1% by weight in homogeneous materials. Where designed to be soldered at high temperatures, "RoHS" products are suitable for use in specified lead-free processes. TI may reference these types of products as "Pb-Free".

**RoHS Exempt:** TI defines "RoHS Exempt" to mean products that contain lead but are compliant with EU RoHS pursuant to a specific EU RoHS exemption.

**Green:** TI defines "Green" to mean the content of Chlorine (Cl) and Bromine (Br) based flame retardants meet JS709B low halogen requirements of <=1000ppm threshold. Antimony trioxide based flame retardants must also meet the <=1000ppm threshold requirement.

(3) MSL, Peak Temp. - The Moisture Sensitivity Level rating according to the JEDEC industry standard classifications, and peak solder temperature.

(4) There may be additional marking, which relates to the logo, the lot trace code information, or the environmental category on the device.

(5) Multiple Device Markings will be inside parentheses. Only one Device Marking contained in parentheses and separated by a "~" will appear on a device. If a line is indented then it is a continuation of the previous line and the two combined represent the entire Device Marking for that device.

(6) Lead finish/Ball material - Orderable Devices may have multiple material finish options. Finish options are separated by a vertical ruled line. Lead finish/Ball material values may wrap to two lines if the finish value exceeds the maximum column width.

**Important Information and Disclaimer:**The information provided on this page represents TI's knowledge and belief as of the date that it is provided. TI bases its knowledge and belief on information provided by third parties, and makes no representation or warranty as to the accuracy of such information. Efforts are underway to better integrate information from third parties. TI has taken and continues to take reasonable steps to provide representative and accurate information but may not have conducted destructive testing or chemical analysis on incoming materials and chemicals. TI and TI suppliers consider certain information to be proprietary, and thus CAS numbers and other limited information may not be available for release.

In no event shall TI's liability arising out of such information exceed the total purchase price of the TI part(s) at issue in this document sold by TI to Customer on an annual basis.

**OTHER QUALIFIED VERSIONS OF TLC2252, TLC2252A, TLC2252AM, TLC2252M, TLC2254, TLC2254A, TLC2254AM, TLC2254M :**

- Catalog : [TLC2252A](#), [TLC2252](#), [TLC2254A](#), [TLC2254](#)
- Automotive : [TLC2252A-Q1](#), [TLC2252A-Q1](#), [TLC2254A-Q1](#), [TLC2254A-Q1](#)
- Enhanced Product : [TLC2252A-EP](#), [TLC2252A-EP](#), [TLC2254A-EP](#), [TLC2254A-EP](#)
- Military : [TLC2252M](#), [TLC2252AM](#), [TLC2254M](#), [TLC2254AM](#)

NOTE: Qualified Version Definitions:

- Catalog - TI's standard catalog product

- Automotive - Q100 devices qualified for high-reliability automotive applications targeting zero defects
- Enhanced Product - Supports Defense, Aerospace and Medical Applications
- Military - QML certified for Military and Defense Applications

**TAPE AND REEL INFORMATION**

**QUADRANT ASSIGNMENTS FOR PIN 1 ORIENTATION IN TAPE**



\*All dimensions are nominal

Device	Package Type	Package Drawing	Pins	SPQ	Reel Diameter (mm)	Reel Width W1 (mm)	A0 (mm)	B0 (mm)	K0 (mm)	P1 (mm)	W (mm)	Pin1 Quadrant
5962-9564003NXDR	SOIC	D	8	2500	330.0	12.4	6.4	5.2	2.1	8.0	12.0	Q1
TLC2252AIDR	SOIC	D	8	2500	330.0	12.4	6.4	5.2	2.1	8.0	12.0	Q1
TLC2252AIPWR	TSSOP	PW	8	2000	330.0	12.4	7.0	3.6	1.6	8.0	12.0	Q1
TLC2252AQDR	SOIC	D	8	2500	330.0	12.5	6.4	5.2	2.1	8.0	12.0	Q1
TLC2252CDR	SOIC	D	8	2500	330.0	12.4	6.4	5.2	2.1	8.0	12.0	Q1
TLC2252CPWR	TSSOP	PW	8	2000	330.0	12.4	7.0	3.6	1.6	8.0	12.0	Q1
TLC2252IDR	SOIC	D	8	2500	330.0	12.4	6.4	5.2	2.1	8.0	12.0	Q1
TLC2254AIDR	SOIC	D	14	2500	330.0	16.4	6.5	9.0	2.1	8.0	16.0	Q1
TLC2254AIPWR	TSSOP	PW	14	2000	330.0	12.4	6.9	5.6	1.6	8.0	12.0	Q1
TLC2254AQDR	SOIC	D	14	2500	330.0	16.4	6.5	9.0	2.1	8.0	16.0	Q1
TLC2254CDR	SOIC	D	14	2500	330.0	16.4	6.5	9.0	2.1	8.0	16.0	Q1
TLC2254CPWR	TSSOP	PW	14	2000	330.0	12.4	6.9	5.6	1.6	8.0	12.0	Q1
TLC2254IDR	SOIC	D	14	2500	330.0	16.4	6.5	9.0	2.1	8.0	16.0	Q1

**TAPE AND REEL BOX DIMENSIONS**

\*All dimensions are nominal

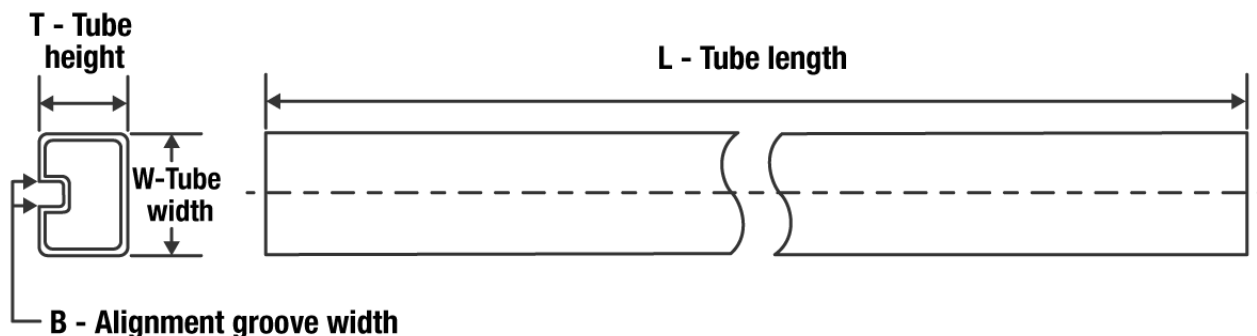
Device	Package Type	Package Drawing	Pins	SPQ	Length (mm)	Width (mm)	Height (mm)
5962-9564003NXDR	SOIC	D	8	2500	350.0	350.0	43.0
TLC2252AIDR	SOIC	D	8	2500	340.5	336.1	25.0
TLC2252AIPWR	TSSOP	PW	8	2000	853.0	449.0	35.0
TLC2252AQDR	SOIC	D	8	2500	340.5	336.1	25.0
TLC2252CDR	SOIC	D	8	2500	340.5	336.1	25.0
TLC2252CPWR	TSSOP	PW	8	2000	853.0	449.0	35.0
TLC2252IDR	SOIC	D	8	2500	340.5	336.1	25.0
TLC2254AIDR	SOIC	D	14	2500	350.0	350.0	43.0
TLC2254AIPWR	TSSOP	PW	14	2000	853.0	449.0	35.0
TLC2254AQDR	SOIC	D	14	2500	350.0	350.0	43.0
TLC2254CDR	SOIC	D	14	2500	350.0	350.0	43.0
TLC2254CPWR	TSSOP	PW	14	2000	853.0	449.0	35.0
TLC2254IDR	SOIC	D	14	2500	350.0	350.0	43.0

**TUBE**

\*All dimensions are nominal

Device	Package Name	Package Type	Pins	SPQ	L (mm)	W (mm)	T (μm)	B (mm)
5962-9564001Q2A	FK	LCCC	20	1	506.98	12.06	2030	NA
5962-9564002Q2A	FK	LCCC	20	1	506.98	12.06	2030	NA
5962-9564003Q2A	FK	LCCC	20	1	506.98	12.06	2030	NA
5962-9564004Q2A	FK	LCCC	20	1	506.98	12.06	2030	NA
TLC2252AID	D	SOIC	8	75	507	8	3940	4.32
TLC2252AID	D	SOIC	8	75	505.46	6.76	3810	4
TLC2252AIDG4	D	SOIC	8	75	507	8	3940	4.32
TLC2252AIDG4	D	SOIC	8	75	505.46	6.76	3810	4
TLC2252AIP	P	PDIP	8	50	506	13.97	11230	4.32
TLC2252AIPW	PW	TSSOP	8	150	530	10.2	3600	3.5
TLC2252AMFKB	FK	LCCC	20	1	506.98	12.06	2030	NA
TLC2252CD	D	SOIC	8	75	507	8	3940	4.32
TLC2252CD	D	SOIC	8	75	505.46	6.76	3810	4
TLC2252CDG4	D	SOIC	8	75	505.46	6.76	3810	4
TLC2252CDG4	D	SOIC	8	75	507	8	3940	4.32
TLC2252CP	P	PDIP	8	50	506	13.97	11230	4.32
TLC2252CPW	PW	TSSOP	8	150	530	10.2	3600	3.5
TLC2252ID	D	SOIC	8	75	507	8	3940	4.32
TLC2252ID	D	SOIC	8	75	505.46	6.76	3810	4
TLC2252IDG4	D	SOIC	8	75	507	8	3940	4.32
TLC2252IDG4	D	SOIC	8	75	505.46	6.76	3810	4
TLC2252IP	P	PDIP	8	50	506	13.97	11230	4.32
TLC2252MFKB	FK	LCCC	20	1	506.98	12.06	2030	NA
TLC2254AID	D	SOIC	14	50	505.46	6.76	3810	4
TLC2254AIDG4	D	SOIC	14	50	505.46	6.76	3810	4
TLC2254AIN	N	PDIP	14	25	506	13.97	11230	4.32
TLC2254AIPW	PW	TSSOP	14	90	530	10.2	3600	3.5
TLC2254AMFKB	FK	LCCC	20	1	506.98	12.06	2030	NA



Device	Package Name	Package Type	Pins	SPQ	L (mm)	W (mm)	T (μm)	B (mm)
TLC2254AQD	D	SOIC	14	50	505.46	6.76	3810	4
TLC2254CD	D	SOIC	14	50	505.46	6.76	3810	4
TLC2254CDG4	D	SOIC	14	50	505.46	6.76	3810	4
TLC2254CN	N	PDIP	14	25	506	13.97	11230	4.32
TLC2254CPW	PW	TSSOP	14	90	530	10.2	3600	3.5
TLC2254ID	D	SOIC	14	50	507	8	3940	4.32
TLC2254ID	D	SOIC	14	50	505.46	6.76	3810	4
TLC2254IDG4	D	SOIC	14	50	505.46	6.76	3810	4
TLC2254IDG4	D	SOIC	14	50	507	8	3940	4.32
TLC2254IN	N	PDIP	14	25	506	13.97	11230	4.32
TLC2254MFKB	FK	LCCC	20	1	506.98	12.06	2030	NA

JG (R-GDIP-T8)

CERAMIC DUAL-IN-LINE



- NOTES: A. All linear dimensions are in inches (millimeters).  
 B. This drawing is subject to change without notice.  
 C. This package can be hermetically sealed with a ceramic lid using glass frit.  
 D. Index point is provided on cap for terminal identification.  
 E. Falls within MIL STD 1835 GDIP1-T8

U0010A



PACKAGE OUTLINE

CFP - 2.03 mm max height

CERAMIC FLATPACK

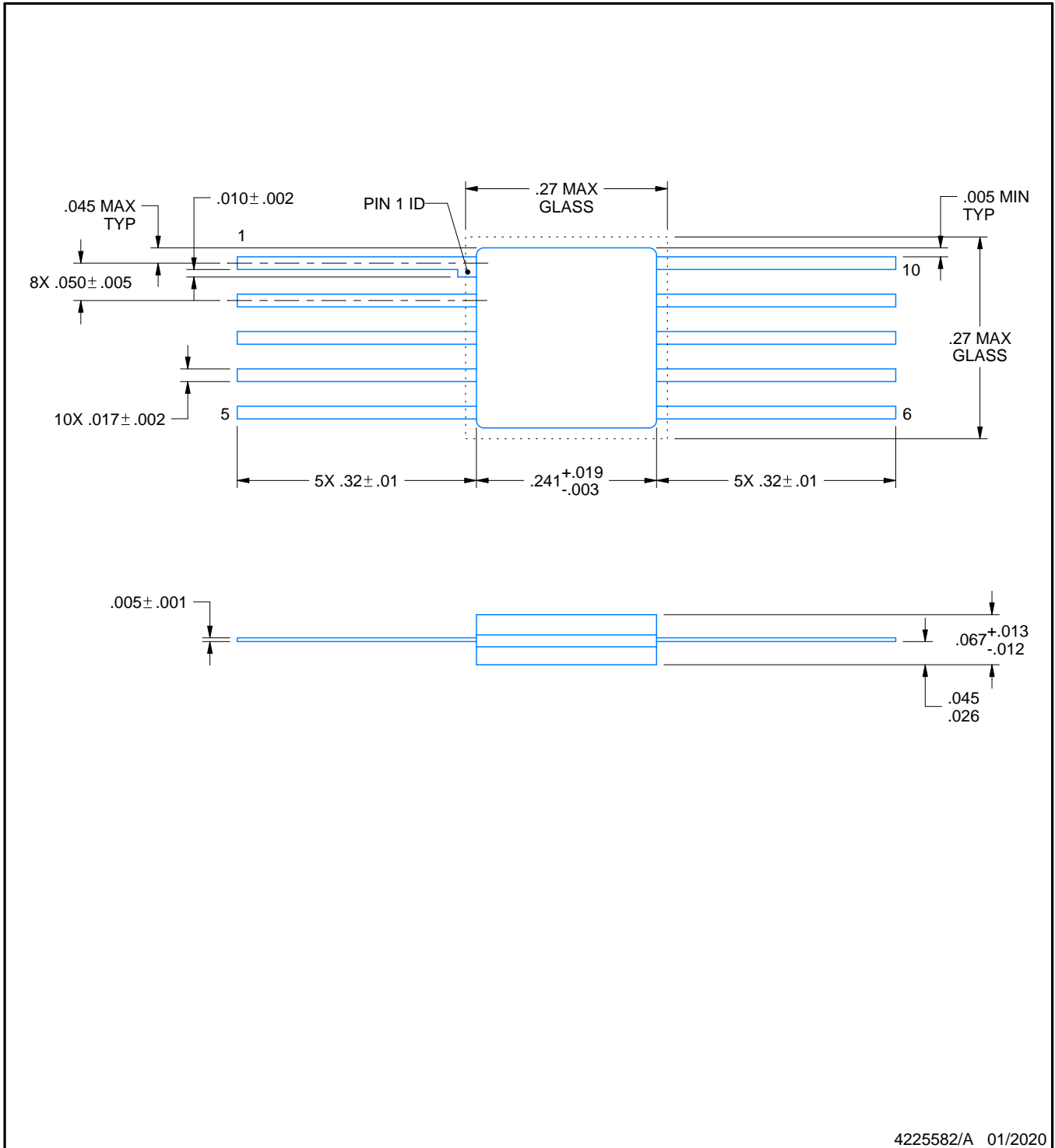

NOTES:

1. All linear dimensions are in inches. Any dimensions in parenthesis are for reference only. Dimensioning and tolerancing per ASME Y14.5M.
2. This drawing is subject to change without notice.

W (R-GDFP-F14)

CERAMIC DUAL FLATPACK



- NOTES:
- A. All linear dimensions are in inches (millimeters).
  - B. This drawing is subject to change without notice.
  - C. This package can be hermetically sealed with a ceramic lid using glass frit.
  - D. Index point is provided on cap for terminal identification only.
  - E. Falls within MIL STD 1835 GDFP1-F14

FK (S-CQCC-N\*\*)

LEADLESS CERAMIC CHIP CARRIER

28 TERMINAL SHOWN



NO. OF TERMINALS **	A		B	
	MIN	MAX	MIN	MAX
20	0.342 (8,69)	0.358 (9,09)	0.307 (7,80)	0.358 (9,09)
28	0.442 (11,23)	0.458 (11,63)	0.406 (10,31)	0.458 (11,63)
44	0.640 (16,26)	0.660 (16,76)	0.495 (12,58)	0.560 (14,22)
52	0.740 (18,78)	0.761 (19,32)	0.495 (12,58)	0.560 (14,22)
68	0.938 (23,83)	0.962 (24,43)	0.850 (21,6)	0.858 (21,8)
84	1.141 (28,99)	1.165 (29,59)	1.047 (26,6)	1.063 (27,0)



4040140/D 01/11

- NOTES:
- All linear dimensions are in inches (millimeters).
  - This drawing is subject to change without notice.
  - This package can be hermetically sealed with a metal lid.
  - Falls within JEDEC MS-004

P (R-PDIP-T8)

PLASTIC DUAL-IN-LINE PACKAGE



- NOTES:
- A. All linear dimensions are in inches (millimeters).
  - B. This drawing is subject to change without notice.
  - C. Falls within JEDEC MS-001 variation BA.

N (R-PDIP-T\*\*)

PLASTIC DUAL-IN-LINE PACKAGE

16 PINS SHOWN





4040049/E 12/2002

- NOTES:
- A. All linear dimensions are in inches (millimeters).
  - B. This drawing is subject to change without notice.
  - (C) Falls within JEDEC MS-001, except 18 and 20 pin minimum body length (Dim A).
  - (D) The 20 pin end lead shoulder width is a vendor option, either half or full width.

D (R-PDSO-G14)

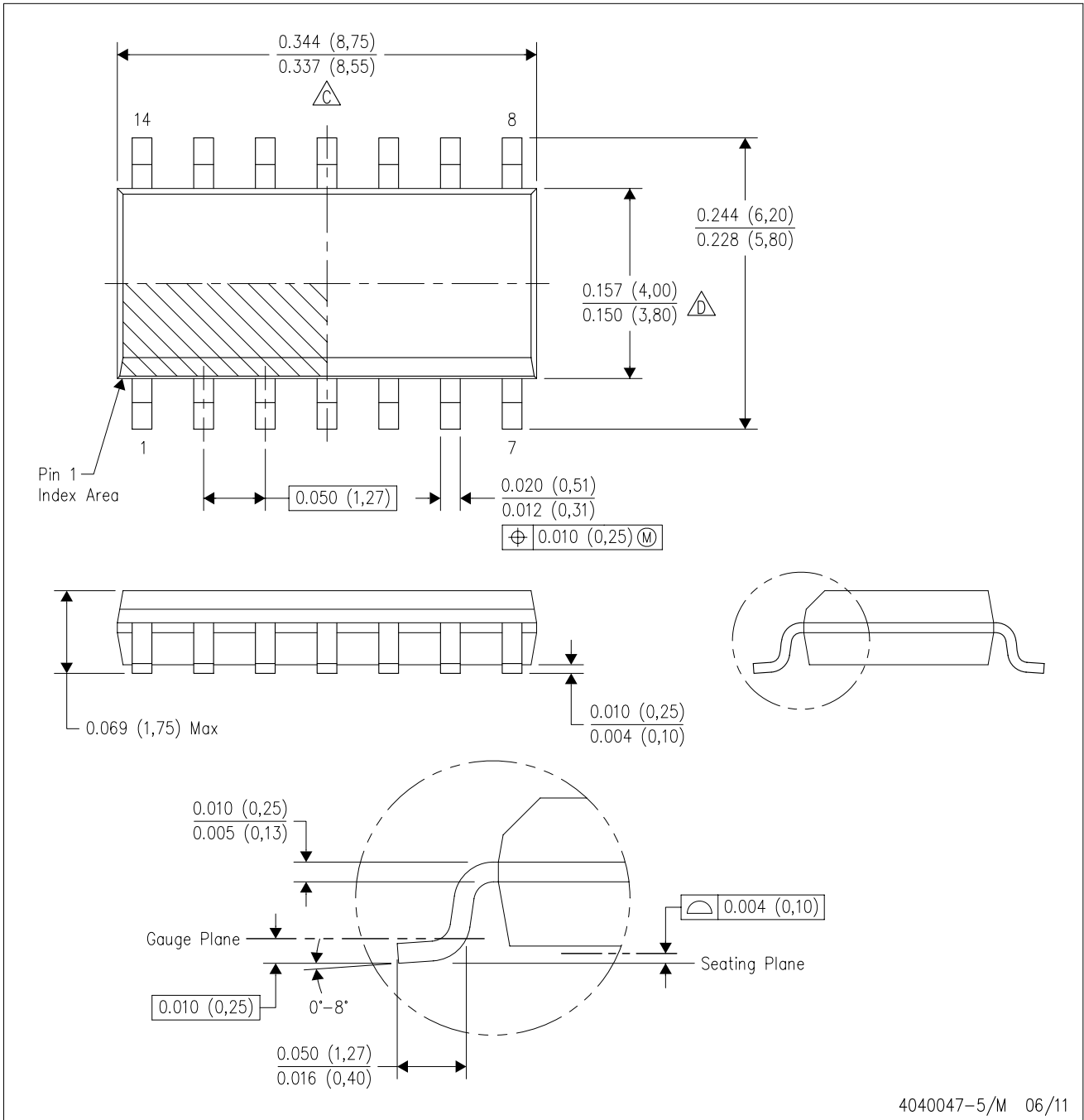
PLASTIC SMALL OUTLINE



- NOTES:
- A. All linear dimensions are in inches (millimeters).
  - B. This drawing is subject to change without notice.
  -  Body length does not include mold flash, protrusions, or gate burrs. Mold flash, protrusions, or gate burrs shall not exceed 0.006 (0,15) each side.
  -  Body width does not include interlead flash. Interlead flash shall not exceed 0.017 (0,43) each side.
  - E. Reference JEDEC MS-012 variation AB.



D (R-PDSO-G14)

PLASTIC SMALL OUTLINE



4211283-3/E 08/12

- NOTES:
- All linear dimensions are in millimeters.
  - This drawing is subject to change without notice.
  - Publication IPC-7351 is recommended for alternate designs.
  - Laser cutting apertures with trapezoidal walls and also rounding corners will offer better paste release. Customers should contact their board assembly site for stencil design recommendations. Refer to IPC-7525 for other stencil recommendations.
  - Customers should contact their board fabrication site for solder mask tolerances between and around signal pads.

# MECHANICAL DATA

PW (R-PDSO-G14)

PLASTIC SMALL OUTLINE

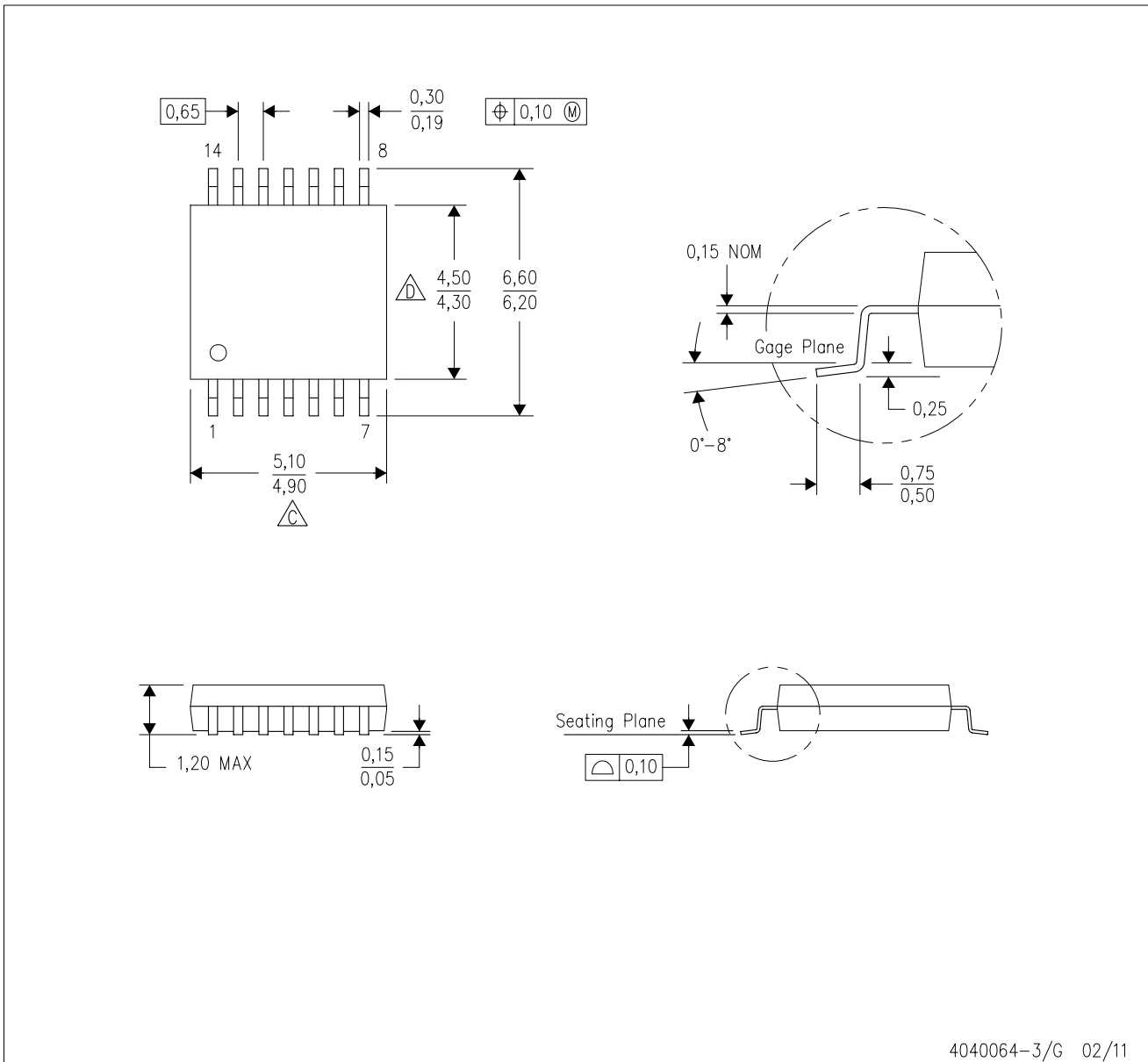

4040064-3/G 02/11

- NOTES:
- A. All linear dimensions are in millimeters. Dimensioning and tolerancing per ASME Y14.5M-1994.
  - B. This drawing is subject to change without notice.
  - C. Body length does not include mold flash, protrusions, or gate burrs. Mold flash, protrusions, or gate burrs shall not exceed 0,15 each side.
  - D. Body width does not include interlead flash. Interlead flash shall not exceed 0,25 each side.
  - E. Falls within JEDEC MO-153

PW0008A



# PACKAGE OUTLINE

## TSSOP - 1.2 mm max height

SMALL OUTLINE PACKAGE



4221848/A 02/2015

### NOTES:

1. All linear dimensions are in millimeters. Any dimensions in parenthesis are for reference only. Dimensioning and tolerancing per ASME Y14.5M.
2. This drawing is subject to change without notice.
3. This dimension does not include mold flash, protrusions, or gate burrs. Mold flash, protrusions, or gate burrs shall not exceed 0.15 mm per side.
4. This dimension does not include interlead flash. Interlead flash shall not exceed 0.25 mm per side.
5. Reference JEDEC registration MO-153, variation AA.

# EXAMPLE BOARD LAYOUT

PW0008A

TSSOP - 1.2 mm max height

SMALL OUTLINE PACKAGE



LAND PATTERN EXAMPLE  
SCALE:10X



SOLDER MASK DETAILS  
NOT TO SCALE

4221848/A 02/2015

NOTES: (continued)

- 6. Publication IPC-7351 may have alternate designs.
- 7. Solder mask tolerances between and around signal pads can vary based on board fabrication site.

# EXAMPLE STENCIL DESIGN

PW0008A

TSSOP - 1.2 mm max height

SMALL OUTLINE PACKAGE



SOLDER PASTE EXAMPLE  
BASED ON 0.125 mm THICK STENCIL  
SCALE:10X

4221848/A 02/2015

NOTES: (continued)

8. Laser cutting apertures with trapezoidal walls and rounded corners may offer better paste release. IPC-7525 may have alternate design recommendations.
9. Board assembly site may have different recommendations for stencil design.



D0008A

# PACKAGE OUTLINE

SOIC - 1.75 mm max height

SMALL OUTLINE INTEGRATED CIRCUIT



4214825/C 02/2019

### NOTES:

1. Linear dimensions are in inches [millimeters]. Dimensions in parenthesis are for reference only. Controlling dimensions are in inches. Dimensioning and tolerancing per ASME Y14.5M.
2. This drawing is subject to change without notice.
3. This dimension does not include mold flash, protrusions, or gate burrs. Mold flash, protrusions, or gate burrs shall not exceed  $.006$  [0.15] per side.
4. This dimension does not include interlead flash.
5. Reference JEDEC registration MS-012, variation AA.

# EXAMPLE BOARD LAYOUT

D0008A

SOIC - 1.75 mm max height

SMALL OUTLINE INTEGRATED CIRCUIT



LAND PATTERN EXAMPLE  
EXPOSED METAL SHOWN  
SCALE:8X



SOLDER MASK DETAILS

4214825/C 02/2019

NOTES: (continued)

- 6. Publication IPC-7351 may have alternate designs.
- 7. Solder mask tolerances between and around signal pads can vary based on board fabrication site.

# EXAMPLE STENCIL DESIGN

D0008A

SOIC - 1.75 mm max height

SMALL OUTLINE INTEGRATED CIRCUIT



SOLDER PASTE EXAMPLE  
BASED ON .005 INCH [0.125 MM] THICK STENCIL  
SCALE:8X

4214825/C 02/2019

NOTES: (continued)

8. Laser cutting apertures with trapezoidal walls and rounded corners may offer better paste release. IPC-7525 may have alternate design recommendations.
9. Board assembly site may have different recommendations for stencil design.



## IMPORTANT NOTICE AND DISCLAIMER

TI PROVIDES TECHNICAL AND RELIABILITY DATA (INCLUDING DATA SHEETS), DESIGN RESOURCES (INCLUDING REFERENCE DESIGNS), APPLICATION OR OTHER DESIGN ADVICE, WEB TOOLS, SAFETY INFORMATION, AND OTHER RESOURCES "AS IS" AND WITH ALL FAULTS, AND DISCLAIMS ALL WARRANTIES, EXPRESS AND IMPLIED, INCLUDING WITHOUT LIMITATION ANY IMPLIED WARRANTIES OF MERCHANTABILITY, FITNESS FOR A PARTICULAR PURPOSE OR NON-INFRINGEMENT OF THIRD PARTY INTELLECTUAL PROPERTY RIGHTS.

These resources are intended for skilled developers designing with TI products. You are solely responsible for (1) selecting the appropriate TI products for your application, (2) designing, validating and testing your application, and (3) ensuring your application meets applicable standards, and any other safety, security, regulatory or other requirements.

These resources are subject to change without notice. TI grants you permission to use these resources only for development of an application that uses the TI products described in the resource. Other reproduction and display of these resources is prohibited. No license is granted to any other TI intellectual property right or to any third party intellectual property right. TI disclaims responsibility for, and you will fully indemnify TI and its representatives against, any claims, damages, costs, losses, and liabilities arising out of your use of these resources.

TI's products are provided subject to [TI's Terms of Sale](#) or other applicable terms available either on [ti.com](http://ti.com) or provided in conjunction with such TI products. TI's provision of these resources does not expand or otherwise alter TI's applicable warranties or warranty disclaimers for TI products.

TI objects to and rejects any additional or different terms you may have proposed.

Mailing Address: Texas Instruments, Post Office Box 655303, Dallas, Texas 75265  
Copyright © 2022, Texas Instruments Incorporated