



FAMILY OF 600 μ A/Ch 2.8MHz RAIL-TO-RAIL INPUT/OUTPUT HIGH-DRIVE OPERATIONAL AMPLIFIERS WITH SHUTDOWN

FEATURES

- **CMOS Rail-To-Rail Input/Output**
- **Input Bias Current: 2.5pA**
- **Low Supply Current: 600 μ A/Channel**
- **Ultra-Low Power Shutdown Mode:**
 $I_{DD(SHDN)}$: 350nA/ch at 3V
 $I_{DD(SHDN)}$: 1000nA/ch at 5V
- **Gain-Bandwidth Product: 2.8MHz**
- **High Output Drive Capability:**
 - ± 10 mA at 180mV
 - ± 35 mA at 500mV
- **Input Offset Voltage: 250 μ V (typ)**
- **Supply Voltage Range: 2.7V to 6V**
- **Ultra-Small Packaging**
 - SOT23-5 or -6 (TLV2470/1)
 - MSOP-8 or -10 (TLV2472/3)

DESCRIPTION

The TLV247x is a family of CMOS rail-to-rail input/output operational amplifiers that establishes a new performance point for supply current versus ac performance. These devices consume just 600 μ A/channel while offering 2.8MHz of gain-bandwidth product. Along with increased ac performance, the amplifier provides high output drive capability, solving a major shortcoming of older micropower operational amplifiers. The TLV247x can swing to within 180mV of each supply rail while driving a 10mA load. For non-RRO applications, the TLV247x can supply ± 35 mA at 500mV off the rail. Both the inputs and outputs swing rail-to-rail for increased dynamic range in low-voltage applications. This performance makes the TLV247x family ideal for sensor interface, portable medical equipment, and other data acquisition circuits.

FAMILY PACKAGE TABLE

DEVICE	NUMBER OF CHANNELS	PACKAGE TYPES					SHUTDOWN	UNIVERSAL EVM BOARD
		PDIP	SOIC	SOT23	TSSOP	MSOP		
TLV2470	1	8	8	6	—	—	Yes	Refer to the EVM Selection Guide (SLOU060)
TLV2471	1	8	8	5	—	—	—	
TLV2472	2	8	8	—	—	8	—	
TLV2473	2	14	14	—	—	10	Yes	
TLV2474	4	14	14	—	14	—	—	
TLV2475	4	16	16	—	16	—	Yes	

A SELECTION OF SINGLE-SUPPLY OPERATIONAL AMPLIFIER PRODUCTS⁽¹⁾

DEVICE	V _{DD} (V)	V _{IO} (μ V)	BW (MHz)	SLEW RATE (V/ μ s)	I _{DD} (per channel) (μ A)	OUTPUT DRIVE	RAIL-TO-RAIL
TLV247X	2.7 – 6.0	250	2.8	1.5	600	± 35 mA	I/O
TLV245X	2.7 – 6.0	20	0.22	0.11	23	± 10 mA	I/O
TLV246X	2.7 – 6.0	150	6.4	1.6	550	± 90 mA	I/O
TLV277X	2.5 – 6.0	360	5.1	10.5	1000	± 10 mA	O

(1) All specifications measured at 5V.



Please be aware that an important notice concerning availability, standard warranty, and use in critical applications of Texas Instruments semiconductor products and disclaimers thereto appears at the end of this data sheet.

PowerPAD is a trademark of Texas Instruments.
 Microsim PARTS is a trademark of MicroSim Corporation.
 Microsim PSpice is a registered trademark of MicroSim Corporation.
 All other trademarks are the property of their respective owners.



This integrated circuit can be damaged by ESD. Texas Instruments recommends that all integrated circuits be handled with appropriate precautions. Failure to observe proper handling and installation procedures can cause damage.

ESD damage can range from subtle performance degradation to complete device failure. Precision integrated circuits may be more susceptible to damage because very small parametric changes could cause the device not to meet its published specifications.

TLV2470 and TLV2471 AVAILABLE OPTIONS⁽¹⁾

T _A	PACKAGED DEVICES			
	SMALL OUTLINE (D) ⁽²⁾	SOT23		PLASTIC DIP (P)
		(DBV) ⁽²⁾	SYMBOL	
0°C to +70°C	TLV2470CD TLV2471CD	TLV2470CDBV TLV2471CDBV	VAUC VAVC	TLV2470CP TLV2471CP
–40°C to +125°C	TLV2470ID TLV2471ID	TLV2470IDBV TLV2471IDBV	VAUI VAVI	TLV2470IP TLV2471IP
	TLV2470AID TLV2471AID	—	—	TLV2470AIP TLV2471AIP

- (1) For the most current package and ordering information see the Package Option Addendum at the end of this document, or see the TI web site at www.ti.com.
 (2) This package is available taped and reeled. To order this packaging option, add an R suffix to the part number (for example, TLV2470CDR).

TLV2472 AND TLV2473 AVAILABLE OPTIONS⁽¹⁾

T _A	PACKAGED DEVICES						
	SMALL OUTLINE (D) ⁽²⁾	MSOP		MSOP		PLASTIC DIP (N)	PLASTIC DIP (P)
		(DGN) ⁽²⁾	SYMBOL ⁽³⁾	(DGQ) ⁽²⁾	SYMBOL ⁽³⁾		
0°C to +70°C	TLV2472CD TLV2473CD	TLV2472CDGN —	xxTIABU —	— TLV2473CDGQ	— xxTIABW	— TLV2473CN	TLV2472CP —
–40°C to +125°C	TLV2472ID TLV2473ID	TLV2472IDGN —	xxTIABV —	— TLV2473IDGQ	— xxTIABX	— TLV2473IN	TLV2472IP —
	TLV2472AID TLV2473AID	—	—	—	—	— TLV2473AIN	TLV2472AIP —

- (1) For the most current package and ordering information see the Package Option Addendum at the end of this document, or see the TI web site at www.ti.com.
 (2) This package is available taped and reeled. To order this packaging option, add an R suffix to the part number (for example, TLV2472CDR).
 (3) xx represents the device date code.

TLV2474 and TLV2475 AVAILABLE OPTIONS⁽¹⁾

T _A	PACKAGED DEVICES		
	SMALL OUTLINE (D) ⁽²⁾	PLASTIC DIP (N)	TSSOP (PWP) ⁽²⁾
0°C to +70°C	TLV2474CD TLV2475CD	TLV2474CN TLV2475CN	TLV2474CPWP TLV2475CPWP
–40°C to +125°C	TLV2474ID TLV2475ID	TLV2474IN TLV2475IN	TLV2474IPWP TLV2475IPWP
	TLV2474AID TLV2475AID	TLV2474AIN TLV2475AIN	TLV2474AIPWP TLV2475AIPWP

- (1) For the most current package and ordering information see the Package Option Addendum at the end of this document, or see the TI web site at www.ti.com.
 (2) This package is available taped and reeled. To order this packaging option, add an R suffix to the part number (for example, TLV2474CDR).

TLV247X PACKAGE PINOUTS

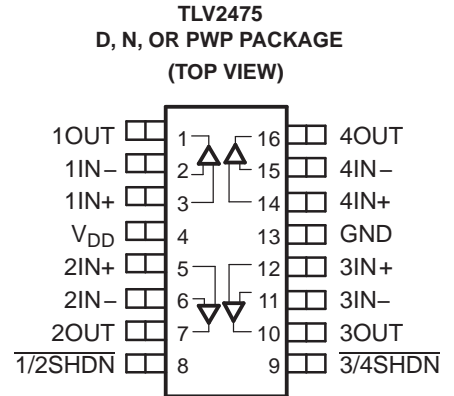
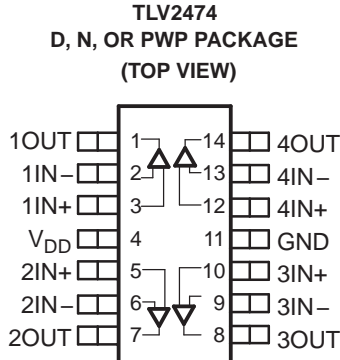
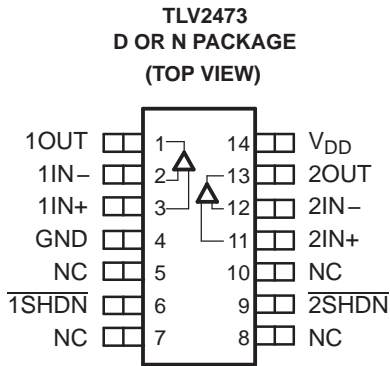
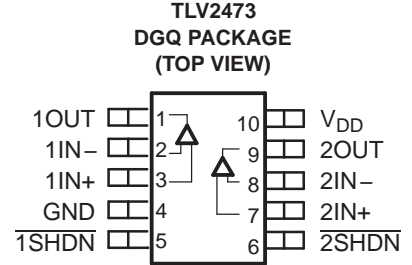
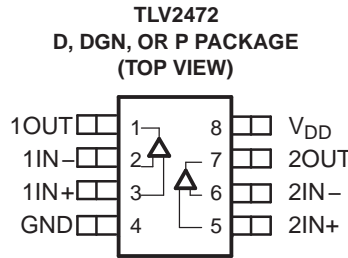
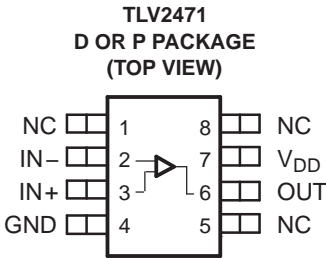
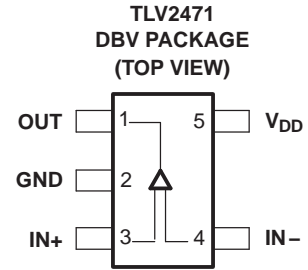
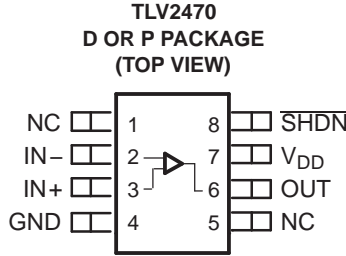
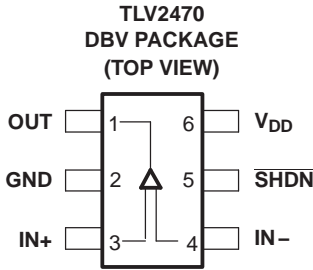

NC – No internal connection

TYPICAL PIN 1 INDICATORS

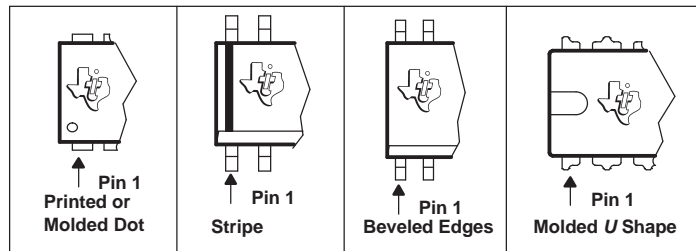

DESCRIPTION (CONTINUED)

Three members of the family (TLV2470/3/5) offer a shutdown terminal for conserving battery life in portable applications. During shutdown, the outputs are placed in a high-impedance state and the amplifier consumes only 350nA/channel. The family is fully specified at 3V and 5V across an expanded industrial temperature range (–40°C to +125°C). The singles and duals are available in the SOT23 and MSOP packages, while the quads are available in TSSOP. The TLV2470 offers an amplifier with shutdown functionality all in a SOT23-6 package, making it perfect for high-density power-sensitive circuits.

ABSOLUTE MAXIMUM RATINGS⁽¹⁾

Over operating free-air temperature range, unless otherwise noted.

		UNIT
Supply voltage, V_{DD} ⁽²⁾		7V
Differential input voltage, V_{ID}		$\pm V_{DD}$
Continuous total power dissipation		See Dissipation Rating table
Operating free-air temperature range, T_A	C-suffix	0°C to +70°C
	I-suffix	–40°C to +125°C
Maximum junction temperature, T_J		+150°C
Storage temperature range, T_{stg}		–65°C to +150°C
Lead temperature 1,6 mm (1/16 inch) from case for 10 seconds		+260°C

- (1) Stresses beyond those listed under *absolute maximum ratings* may cause permanent damage to the device. These are stress ratings only, and functional operation of the device at these or any other conditions beyond those indicated under *recommended operating conditions* is not implied. Exposure to absolute-maximum-rated conditions for extended periods may affect device reliability.
- (2) All voltage values, except differential voltages, are with respect to GND.

DISSIPATION RATING TABLE

PACKAGE	θ_{JC} (°C/W)	θ_{JA} (°C/W)	$T_A \leq +25^\circ\text{C}$ POWER RATING
D (8)	38.3	176	710mW
D (14)	26.9	122.3	1022mW
D (16)	25.7	114.7	1090mW
DBV (5)	55	324.1	385mW
DBV (6)	55	294.3	425mW
DGN (8)	4.7	52.7	2.37W
DGQ (10)	4.7	52.3	2.39W
N (14, 16)	32	78	1600mW
P (8)	41	104	1200mW
PWP (14)	2.07	30.7	4.07W
PWP (16)	2.07	29.7	4.21W

RECOMMENDED OPERATING CONDITIONS

		MIN	MAX	UNIT
Supply voltage, V_{DD}	Single supply	2.7	6	V
	Split supply	± 1.35	± 3	
Common-mode input voltage range, V_{ICR}		0	V_{DD}	V
Operating free-air temperature, T_A	C-suffix	0	+70	°C
	I-suffix	–40	+125	
Shutdown on/off voltage level ⁽¹⁾	V_{IH}	2		V
	V_{IL}		0.8	

- (1) Relative to GND.

ELECTRICAL CHARACTERISTICS

At specified free-air temperature, $V_{DD} = 3V$, unless otherwise noted.

PARAMETER	TEST CONDITIONS	$T_A^{(1)}$	MIN	TYP	MAX	UNIT	
V_{IO} Input offset voltage		TLV247x	+25°C	250	2200	μV	
			Full range		2400		
		TLV247xA	+25°C	250	1600		
			Full range		1800		
α_{VIO} Temperature coefficient of input offset voltage	$V_{IC} = V_{DD}/2$, $V_O = V_{DD}/2$, $R_S = 50\Omega$			0.4		$\mu V/^\circ C$	
		25°C	1.5	50			
I_{IO} Input offset current		TLV247xC	Full range			100	μA
		TLV247xI	Full range			300	
I_{IB} Input bias current		+25°C		2	50		
	TLV247xC	Full range			100		
	TLV247xI	Full range			300		
V_{OH} High-level output voltage	$V_{IC} = V_{DD}/2$	$I_{OH} = -2.5mA$	+25°C	2.85	2.94	V	
			Full range		2.8		
		$I_{OH} = -10mA$	+25°C	2.6	2.74		
			Full range		2.5		
V_{OL} Low-level output voltage	$V_{IC} = V_{DD}/2$	$I_{OL} = 2.5mA$	+25°C		0.07	0.15	V
			Full range			0.2	
		$I_{OL} = 10mA$	+25°C		0.2	0.35	
			Full range			0.5	
I_{OS} Short-circuit output current	Sourcing		+25°C	30		mA	
		Full range		20			
	Sinking		+25°C	30			
		Full range		20			
I_O Output current	$V_O = 0.5V$ from rail		+25°C	± 22		mA	
A_{VD} Large-signal differential voltage amplification	$V_{O(PP)} = 1V$, $R_L = 10k\Omega$		+25°C	90	116	dB	
		Full range		88			
$r_{i(d)}$ Differential input resistance			+25°C	10^{12}		Ω	
C_{IC} Common-mode input capacitance	$f = 10kHz$		+25°C	19.3		pF	
z_o Closed-loop output impedance	$f = 10kHz$, $A_V = 10$		+25°C	2		Ω	
CMRR Common-mode rejection ratio	$V_{IC} = 0V$ to $3V$, $R_S = 50\Omega$		+25°C	61	78	dB	
		TLV247xC	Full range	59			
		TLV247xI	Full range	58			

(1) Full range is 0°C to +70°C for C-suffix and –40°C to +125°C for I-suffix. If not specified, full range is –40°C to +125°C.

ELECTRICAL CHARACTERISTICS (continued)

At specified free-air temperature, $V_{DD} = 3V$, unless otherwise noted.

PARAMETER		TEST CONDITIONS		$T_A^{(1)}$	MIN	TYP	MAX	UNIT
k_{SVR}	Supply voltage rejection ratio ($\Delta V_{DD}/\Delta V_{IO}$)	$V_{DD} = 2.7V$ to $6V$, $V_{IC} = V_{DD}/2$, No load		+25°C	74	90	dB	
				Full range	66			
		$V_{DD} = 3V$ to $5V$, $V_{IC} = V_{DD}/2$, No load		+25°C	77	92		
				Full range	68			
I_{DD}	Supply current (per channel)	$V_O = 1.5V$, No load		+25°C		550	750	μA
				Full range			800	
$I_{DD(SHDN)}$	Supply current in shutdown mode (TLV2470, TLV2473, TLV2475) (per channel)	$\overline{SHDN} = 0V$		+25°C		350	1500	nA
			TLV247xC	Full range			2000	
			TLV247xI	Full range			4000	

(1) Full range is 0°C to +70°C for C-suffix and –40°C to +125°C for I-suffix. If not specified, full range is –40°C to +125°C.

OPERATING CHARACTERISTICS

At specified free-air temperature, $V_{DD} = 3V$, unless otherwise noted.

PARAMETER		TEST CONDITIONS		$T_A^{(1)}$	MIN	TYP	MAX	UNIT
SR	Slew rate at unity gain	$V_{O(PP)} = 0.8V$, $C_L = 150pF$, $R_L = 10k\Omega$		+25°C	1.1	1.4	$V/\mu s$	
				Full range	0.6			
V_n	Equivalent input noise voltage	$f = 100Hz$		+25°C		28	nV/\sqrt{Hz}	
		$f = 1kHz$		+25°C		15		
I_n	Equivalent input noise current	$f = 1kHz$		+25°C		0.405	pA/\sqrt{Hz}	
THD+N	Total harmonic distortion plus noise	$V_{O(PP)} = 2V$, $R_L = 10k\Omega$, $f = 1kHz$		$A_V = 1$	+25°C		0.02%	
				$A_V = 10$			0.1%	
				$A_V = 100$			0.5%	
$t_{(on)}$	Amplifier turn-on time	$R_L = OPEN^{(2)}$		+25°C		5	μs	
$t_{(off)}$	Amplifier turn-off time			+25°C		250	ns	
	Gain-bandwidth product	$f = 10kHz$, $R_L = 600\Omega$		+25°C		2.8	MHz	
t_s	Settling time	$V_{(STEP)PP} = 2V$, $A_V = -1$, $C_L = 10pF$, $R_L = 10k\Omega$		0.1%	+25°C		1.5	μs
				0.01%			3.9	
		$V_{(STEP)PP} = 2V$, $A_V = -1$, $C_L = 56pF$, $R_L = 10k\Omega$		0.1%			1.6	
				0.01%			4	
Φ_m	Phase margin	$R_L = 10k\Omega$, $C_L = 1000pF$		+25°C		61	°	
	Gain margin	$R_L = 10k\Omega$, $C_L = 1000pF$		+25°C		15	dB	

(1) Full range is 0°C to +70°C for C-suffix and –40°C to +125°C for I-suffix. If not specified, full range is –40°C to +125°C.

(2) Disable and enable time are defined as the interval between application of logic signal to \overline{SHDN} and the point at which the supply current has reached half its final value.

ELECTRICAL CHARACTERISTICS

At specified free-air temperature, $V_{DD} = 5V$, unless otherwise noted.

PARAMETER	TEST CONDITIONS	T_A ⁽¹⁾	MIN	TYP	MAX	UNIT
V_{IO} Input offset voltage		TLV247x	+25°C	250	2200	μV
			Full range		2400	
		TLV247xA	+25°C	250	1600	
			Full range		2000	
α_{VIO} Temperature coefficient of input offset voltage	$V_{IC} = V_{DD}/2$, $V_O = V_{DD}/2$, $R_S = 50\Omega$			0.4		$\mu V/^\circ C$
I_{IO} Input offset current		+25°C	1.7	50	pA	
		TLV247xC	Full range			100
			TLV247xI	Full range		
I_{IB} Input bias current		+25°C	2.5	50	pA	
	TLV247xC	Full range		100		
		TLV247xI	Full range			300
V_{OH} High-level output voltage	$V_{IC} = V_{DD}/2$	$I_{OH} = -2.5mA$	+25°C	4.85	4.96	V
			Full range		4.8	
		$I_{OH} = -10mA$	+25°C	4.72	4.82	
			Full range		4.65	
V_{OL} Low-level output voltage	$V_{IC} = V_{DD}/2$	$I_{OL} = 2.5mA$	+25°C	0.07	0.15	V
			Full range		0.2	
		$I_{OL} = 10mA$	+25°C	0.178	0.28	
			Full range		0.35	
I_{OS} Short-circuit output current	Sourcing		+25°C	110	mA	
		Full range		60		
	Sinking		+25°C	90		
		Full range		60		
I_O Output current	$V_O = 0.5V$ from rail		+25°C	± 35	mA	
A_{VD} Large-signal differential voltage amplification	$V_{O(PP)} = 3V$, $R_L = 10k\Omega$		+25°C	92	120	dB
		Full range		91		
$r_{i(d)}$ Differential input resistance			+25°C	10^{12}	Ω	
C_{IC} Common-mode input capacitance	$f = 10kHz$		+25°C	18.9	pF	
Z_o Closed-loop output impedance	$f = 10kHz$, $A_V = 10$		+25°C	1.8	Ω	
CMRR Common-mode rejection ratio	$V_{IC} = 0V$ to $5V$, $R_S = 50\Omega$		+25°C	64	84	dB
		TLV247xC	Full range	63		
		TLV247xI	Full range	58		
k_{SVR} Supply voltage rejection ratio ($\Delta V_{DD}/\Delta V_{IO}$)	$V_{DD} = 2.7V$ to $6V$, $V_{IC} = V_{DD}/2$, No load		+25°C	74	90	dB
		Full range		66		
	$V_{DD} = 3V$ to $5V$, $V_{IC} = V_{DD}/2$, No load		+25°C	77	92	
		Full range		66		
I_{DD} Supply current (per channel)	$V_O = 2.5V$, No load		+25°C	600	900	μA
		Full range			1000	

(1) Full range is 0°C to +70°C for C-suffix and -40°C to +125°C for I-suffix. If not specified, full range is -40°C to +125°C.

ELECTRICAL CHARACTERISTICS (continued)

At specified free-air temperature, $V_{DD} = 5V$, unless otherwise noted.

PARAMETER		TEST CONDITIONS	$T_A^{(1)}$	MIN	TYP	MAX	UNIT	
$I_{DD(SHDN)}$	Supply current in shutdown mode (TLV2470, TLV2473, TLV2475) (per channel)	$\overline{SHDN} = 0V$	+25°C	1000	2500		nA	
			TLV247xC	Full range		3000		nA
			TLV247xI	Full range		6000		nA

(1) Full range is 0°C to +70°C for C-suffix and –40°C to +125°C for I-suffix. If not specified, full range is –40°C to +125°C.

OPERATING CHARACTERISTICS

At specified free-air temperature, $V_{DD} = 5V$, unless otherwise noted.

PARAMETER		TEST CONDITIONS	$T_A^{(1)}$	MIN	TYP	MAX	UNIT
SR	Slew rate at unity gain	$V_{O(PP)} = 2V$, $C_L = 150pF$, $R_L = 10k\Omega$	+25°C	1.1	1.5		V/ μs
			Full range	0.7			
V_n	Equivalent input noise voltage	$f = 100Hz$	+25°C		28		nV/ \sqrt{Hz}
		$f = 1kHz$	+25°C		15		
I_n	Equivalent input noise current	$f = 1kHz$	+25°C		0.39		pA/ \sqrt{Hz}
THD + N	Total harmonic distortion plus noise	$V_{O(PP)} = 4V$, $R_L = 10k\Omega$, $f = 1kHz$	+25°C			$A_V = 1$	0.01%
						$A_V = 10$	0.05%
						$A_V = 100$	0.3%
$t_{(on)}$	Amplifier turn-on time	$R_L = OPEN^{(2)}$	+25°C		5		μs
$t_{(off)}$	Amplifier turn-off time		+25°C		250		ns
	Gain-bandwidth product	$f = 10kHz$, $R_L = 600\Omega$	+25°C		2.8		MHz
t_s	Settling time	$V_{(STEP)PP} = 2V$, $A_V = -1$, $C_L = 10pF$, $R_L = 10k\Omega$	+25°C			0.1%	1.8
						0.01%	3.3
		$V_{(STEP)PP} = 2V$, $A_V = -1$, $C_L = 56pF$, $R_L = 10k\Omega$				0.1%	1.7
						0.01%	3
Φ_m	Phase margin	$R_L = 10k\Omega$, $C_L = 1000pF$	+25°C		68		°
	Gain margin	$R_L = 10k\Omega$, $C_L = 1000pF$	+25°C		23		dB

(1) Full range is 0°C to +70°C for C suffix and –40°C to +125°C for I suffix. If not specified, full range is –40°C to +125°C.

(2) Disable and enable time are defined as the interval between application of logic signal to \overline{SHDN} and the point at which the supply current has reached half its final value.

TYPICAL CHARACTERISTICS

Table of Graphs

			FIGURE
V_{IO}	Input offset voltage	vs Common-mode input voltage	Figure 1, Figure 2
I_{IB}	Input bias current	vs Free-air temperature	Figure 3, Figure 4
I_{IO}	Input offset current		
V_{OH}	High-level output voltage	vs High-level output current	Figure 5, Figure 7
V_{OL}	Low-level output voltage	vs Low-level output current	Figure 6, Figure 8
Z_o	Output impedance	vs Frequency	Figure 9
I_{DD}	Supply current	vs Supply voltage	Figure 10
PSRR	Power-supply rejection ratio	vs Frequency	Figure 11
CMRR	Common-mode rejection ratio	vs Frequency	Figure 12
V_n	Equivalent input noise voltage	vs Frequency	Figure 13
$V_{O(PP)}$	Maximum peak-to-peak output voltage	vs Frequency	Figure 14, Figure 15
A_{VD}	Differential voltage gain and phase	vs Frequency	Figure 16, Figure 17
Φ_m	Phase margin	vs Load capacitance	Figure 18, Figure 19
	Gain margin	vs Load capacitance	Figure 20, Figure 21
	Gain-bandwidth product	vs Supply voltage	Figure 22
SR	Slew rate	vs Supply voltage	Figure 23
		vs Free-air temperature	Figure 24, Figure 25
	Crosstalk	vs Frequency	Figure 26
THD+N	Total harmonic distortion + noise	vs Frequency	Figure 27, Figure 28
V_o	Large and small signal follower	vs Time	Figure 29–Figure 32
	Shutdown pulse response	vs Time	Figure 33, Figure 34
	Shutdown forward and reverse isolation	vs Frequency	Figure 35, Figure 36
$I_{DD(SHDN)}$	Shutdown supply current	vs Supply voltage	Figure 37
$I_{DD(SHDN)}$	Shutdown supply current	vs Free-air temperature	Figure 38
$I_{DD(SHDN)}$	Shutdown pulse current	vs Time	Figure 39, Figure 40

TYPICAL CHARACTERISTICS

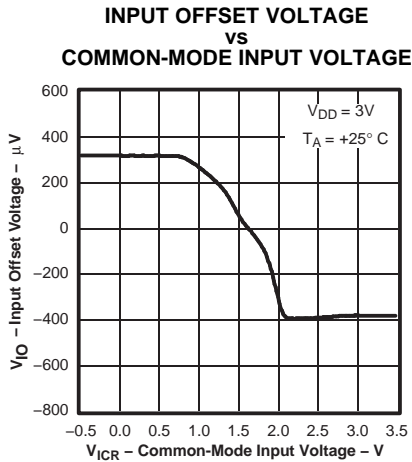

Figure 1.

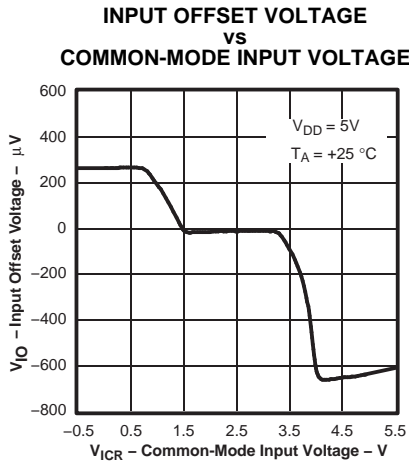

Figure 2.

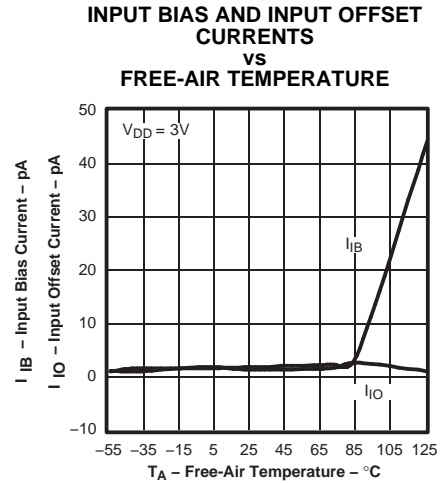

Figure 3.

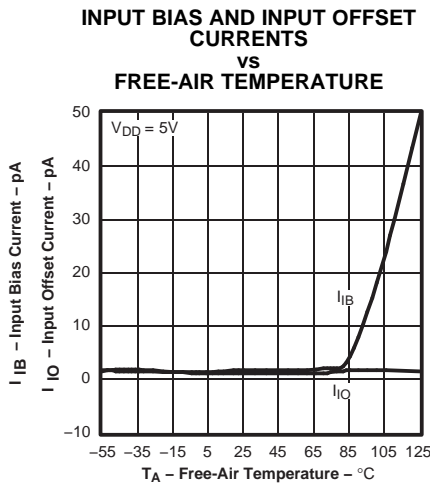

Figure 4.

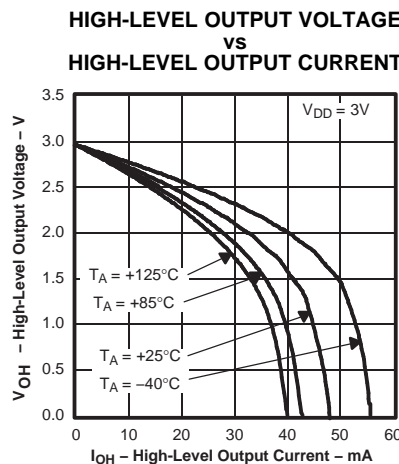

Figure 5.

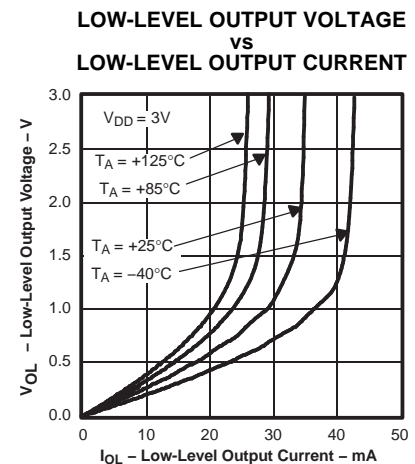

Figure 6.

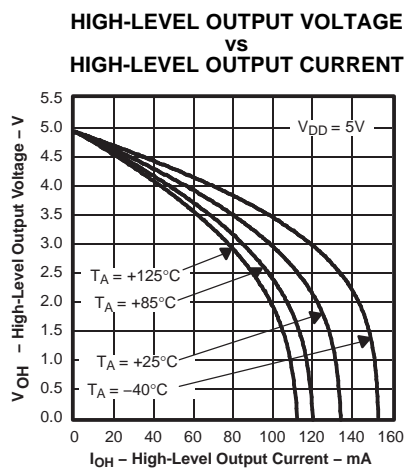

Figure 7.

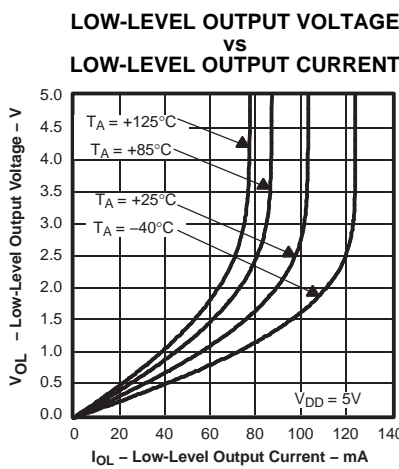

Figure 8.

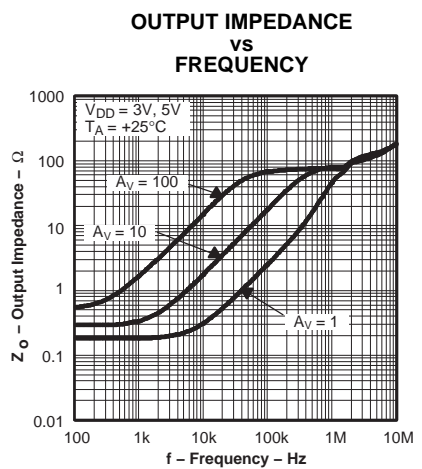

Figure 9.

TYPICAL CHARACTERISTICS (continued)

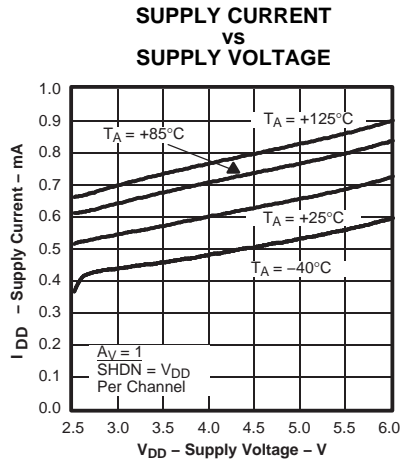

Figure 10.

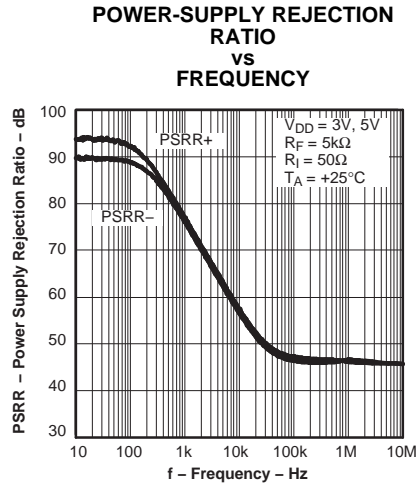

Figure 11.

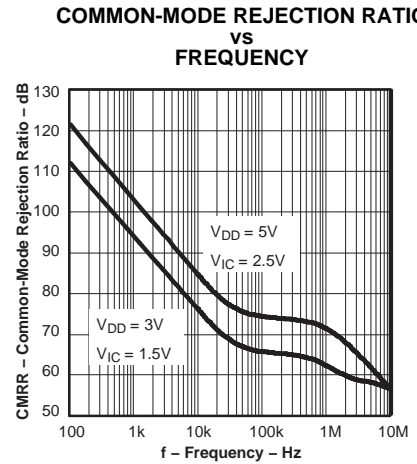

Figure 12.

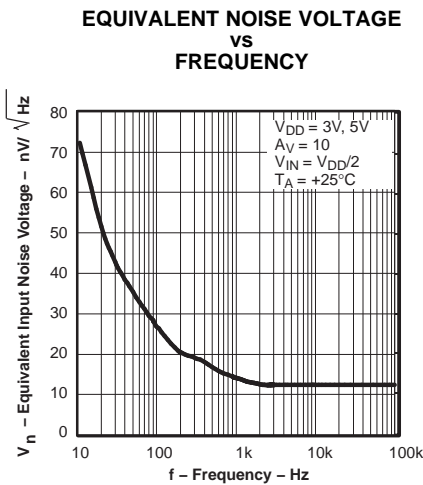

Figure 13.

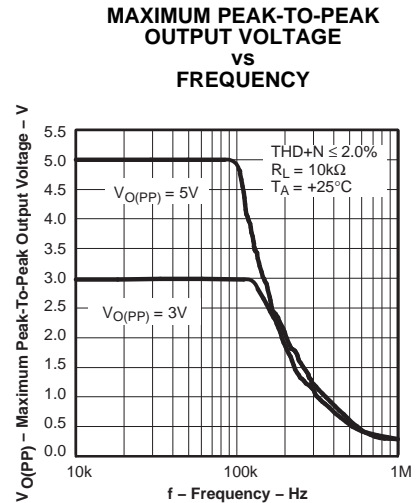

Figure 14.

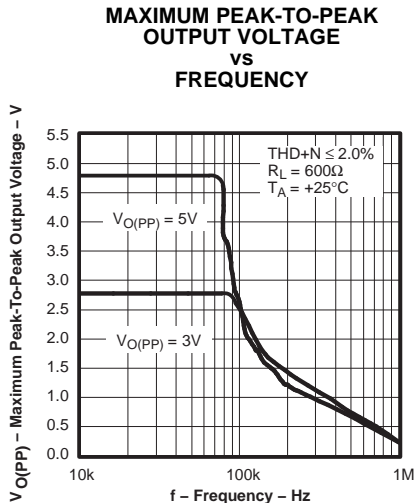

Figure 15.

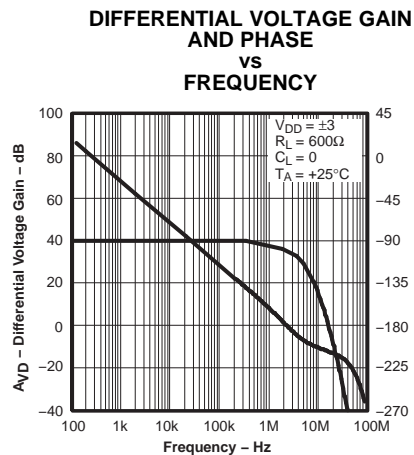

Figure 16.

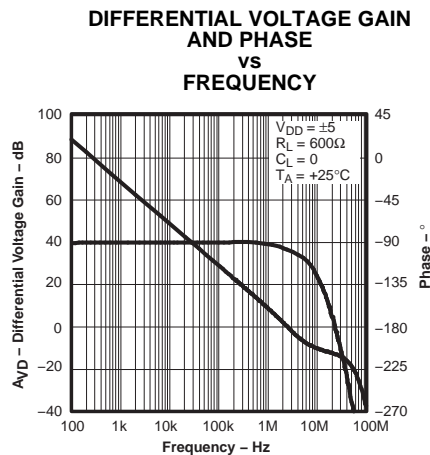

Figure 17.

TYPICAL CHARACTERISTICS (continued)

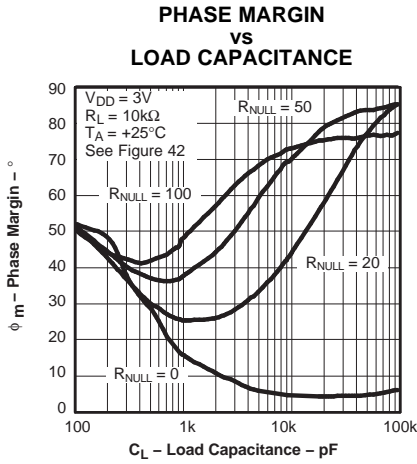

Figure 18.

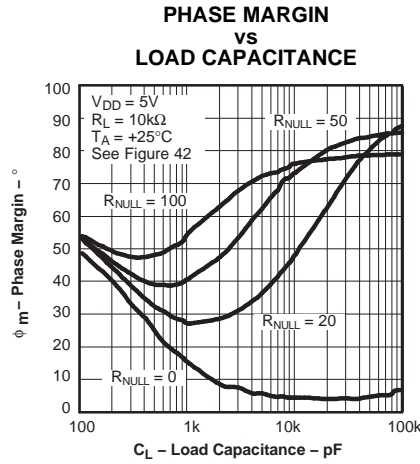

Figure 19.

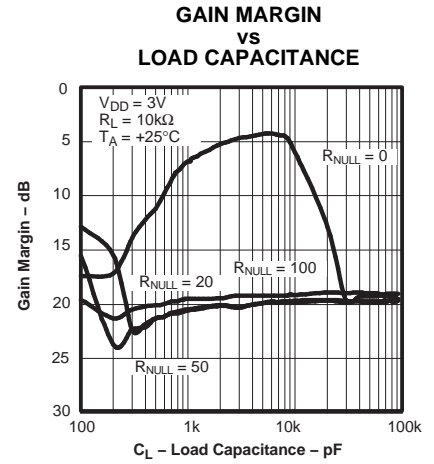

Figure 20.

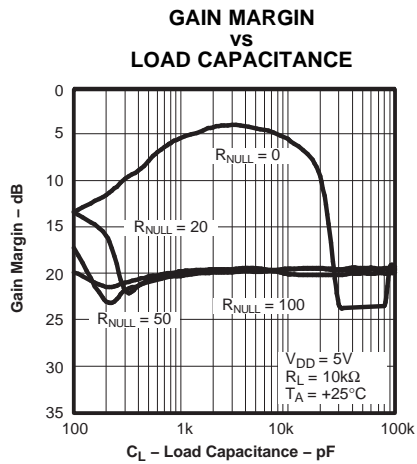

Figure 21.

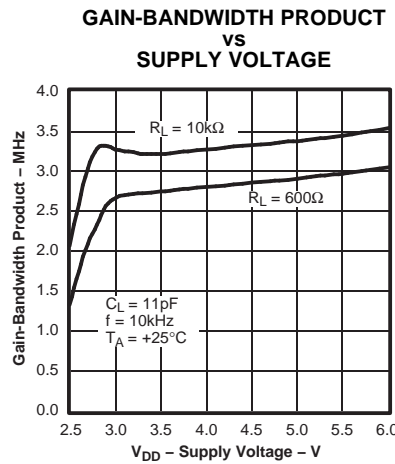

Figure 22.

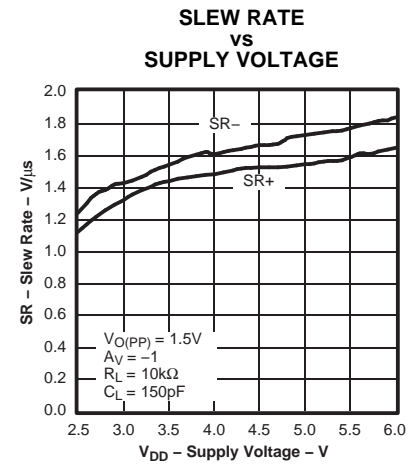

Figure 23.

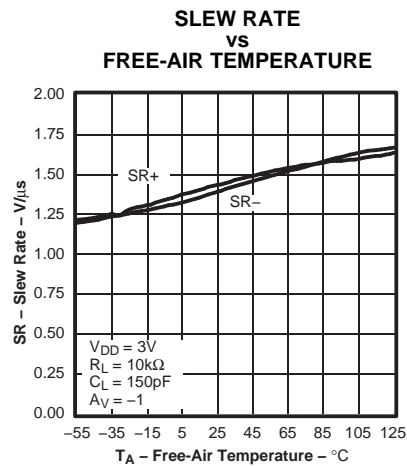

Figure 24.

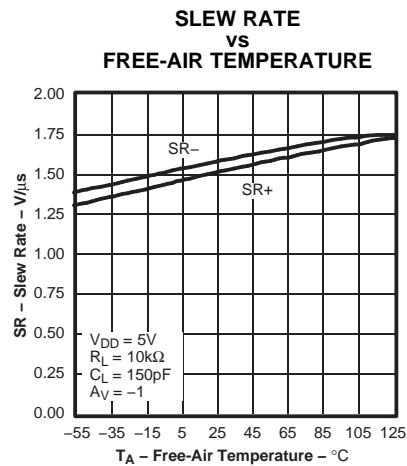

Figure 25.

TYPICAL CHARACTERISTICS (continued)

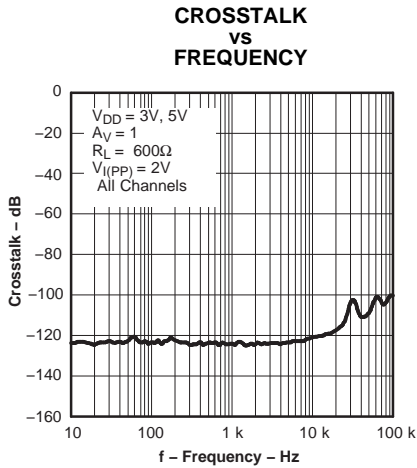

Figure 26.

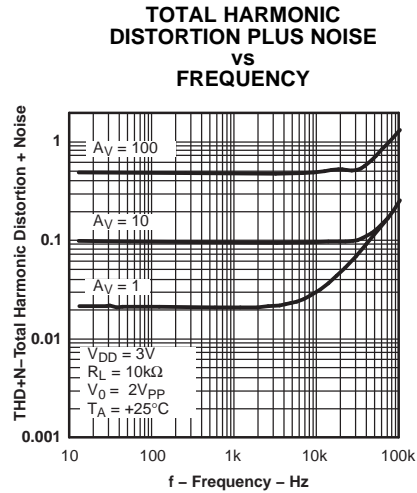

Figure 27.

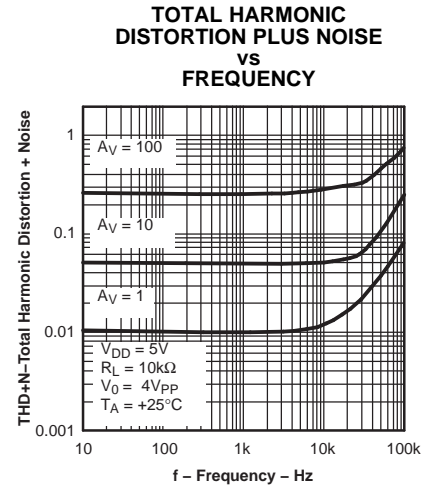

Figure 28.

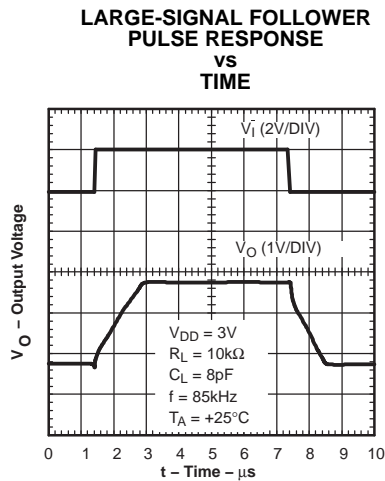

Figure 29.

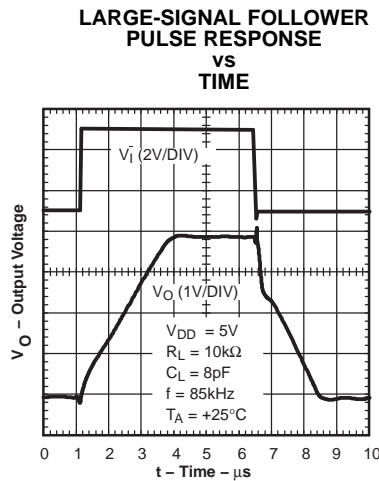

Figure 30.

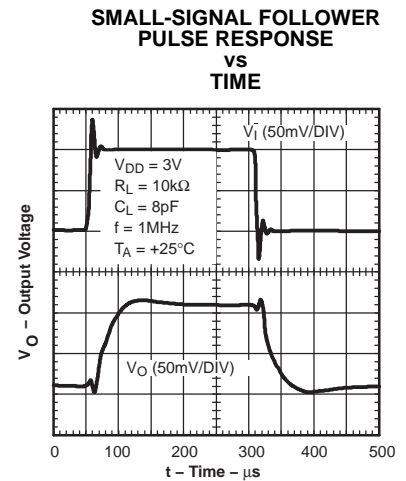

Figure 31.

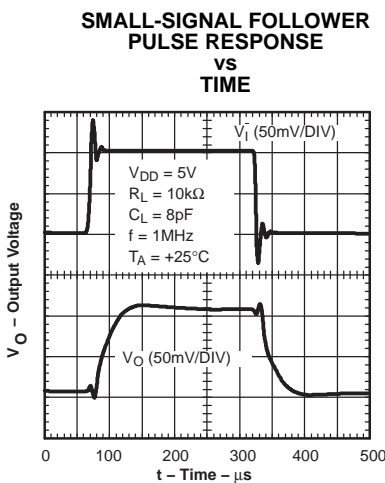

Figure 32.

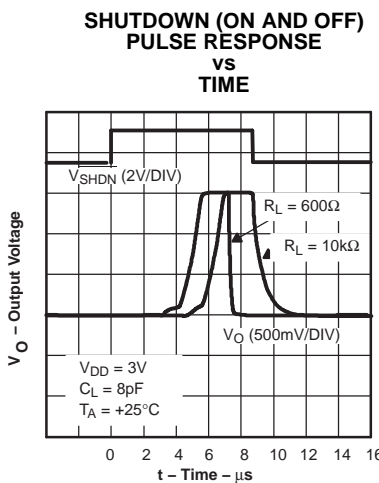

Figure 33.

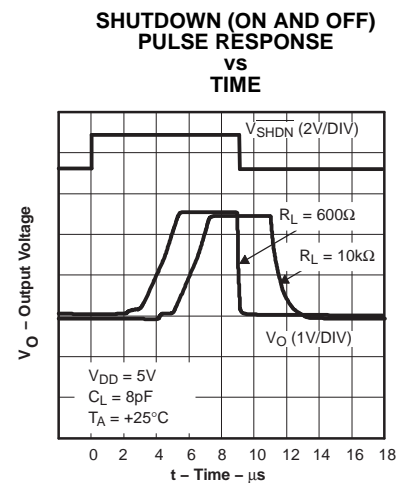

Figure 34.

TYPICAL CHARACTERISTICS (continued)

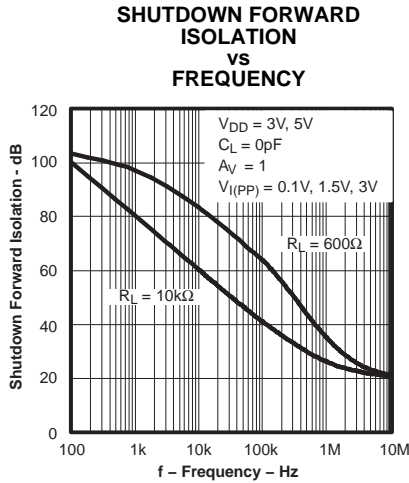

Figure 35.

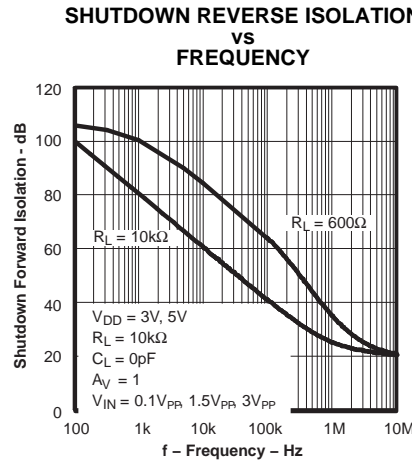

Figure 36.

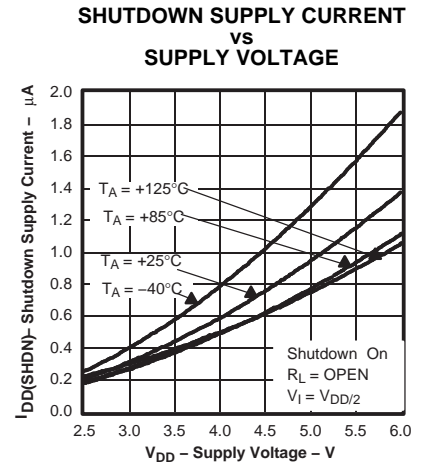

Figure 37.

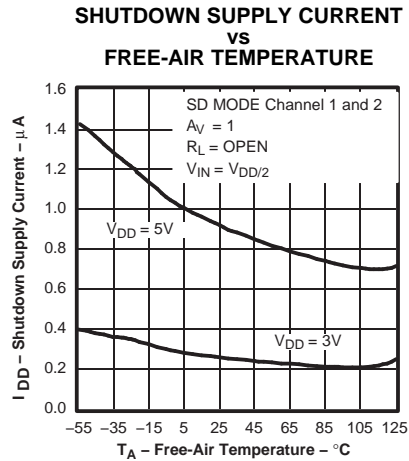

Figure 38.

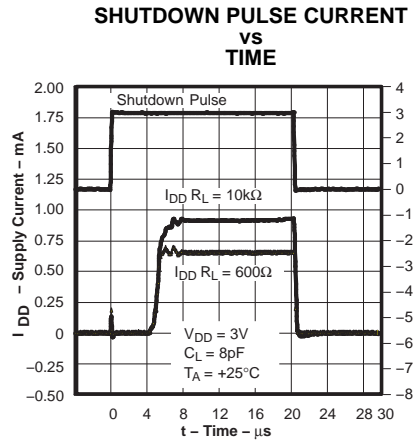

Figure 39.

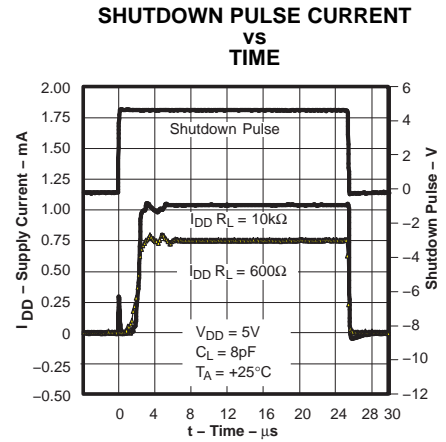

Figure 40.

PARAMETER MEASUREMENT INFORMATION

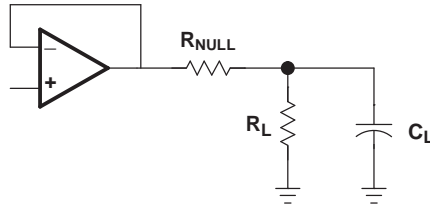

Figure 41.

APPLICATION INFORMATION

DRIVING A CAPACITIVE LOAD

When the amplifier is configured in this manner, capacitive loading directly on the output will decrease the device phase margin leading to high-frequency ringing or oscillations. Therefore, for capacitive loads of greater than 10pF, it is recommended that a resistor (R_{NULL}) be placed in series with the output of the amplifier, as shown in Figure 42. A minimum value of 20Ω should work well for most applications.

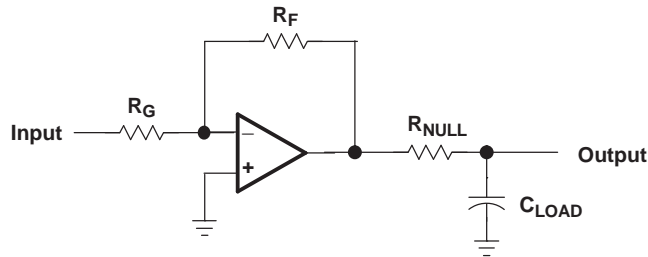
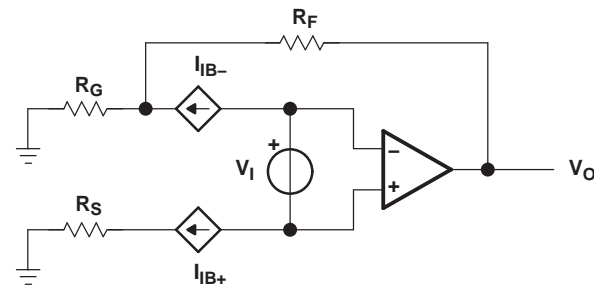

Figure 42. Driving a Capacitive Load

OFFSET VOLTAGE

The output offset voltage (V_{OO}) is the sum of the input offset voltage (V_{IO}) and both input bias currents (I_{IB}) times the corresponding gains. The following schematic and formula can be used to calculate the output offset voltage:



$$V_{OO} = V_{IO} \left(1 + \left(\frac{R_F}{R_G} \right) \right) \pm I_{IB+} R_S \left(1 + \left(\frac{R_F}{R_G} \right) \right) \pm I_{IB-} R_F$$

Figure 43. Output Offset Voltage Model

APPLICATION INFORMATION (continued)

GENERAL CONFIGURATIONS

When receiving low-level signals, limiting the bandwidth of the incoming signals into the system is often required. The simplest way to accomplish this is to place an RC filter at the noninverting terminal of the amplifier (see Figure 44).

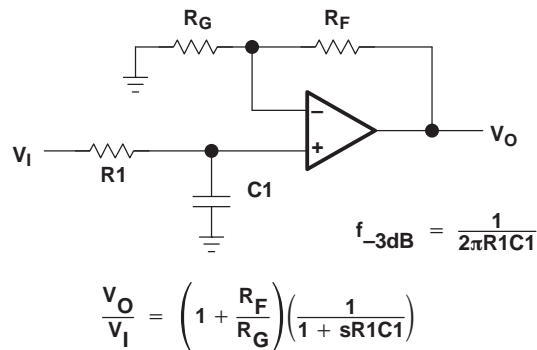

Figure 44. Single-Pole Low-Pass Filter

If even more attenuation is needed, a multiple pole filter is required. The Sallen-Key filter can be used for this task. For best results, the amplifier should have a bandwidth that is eight to ten times the filter frequency bandwidth. Failure to do this can result in phase shift of the amplifier.

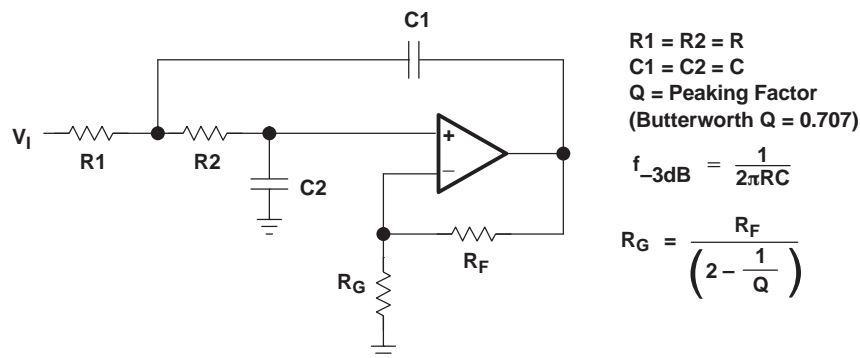

Figure 45. 2-Pole Low-Pass Sallen-Key Filter

SHUTDOWN FUNCTION

Three members of the TLV247x family (TLV2470/3/5) have a shutdown terminal for conserving battery life in portable applications. When the shutdown terminal is tied low, the supply current is reduced to 350nA/channel, the amplifier is disabled, and the outputs are placed in a high impedance mode. To enable the amplifier, the shutdown terminal can either be left floating or pulled high. When the shutdown terminal is left floating, care should be taken to ensure that parasitic leakage current at the shutdown terminal does not inadvertently place the operational amplifier into shutdown. The shutdown terminal threshold is always referenced to $V_{DD}/2$. Therefore, when operating the device with split supply voltages (e.g., $\pm 2.5V$), the shutdown terminal needs to be pulled to V_{DD-} (not GND) to disable the operational amplifier.

The amplifier output with a shutdown pulse is shown in Figure 33 and Figure 34. The amplifier is powered with a single 5V supply and configured as a noninverting configuration with a gain of 5. The amplifier turn-on and turn-off times are measured from the 50% point of the shutdown pulse to the 50% point of the output waveform. The times for the single, dual, and quad versions are listed in the data tables.

APPLICATION INFORMATION (continued)

Figure 35 and Figure 36 show the amplifier forward and reverse isolation in shutdown. The operational amplifier is powered by $\pm 1.35\text{V}$ supplies and configured as a voltage follower ($A_V = 1$). The isolation performance is plotted across frequency using 0.1V_{PP} , 1.5V_{PP} , and 2.5V_{PP} input signals. During normal operation, the amplifier would not be able to handle a 2.5V_{PP} input signal with a supply voltage of $\pm 1.35\text{V}$ since it exceeds the common-mode input voltage range (V_{ICR}). However, this curve illustrates that the amplifier remains in shutdown even under a worst case scenario.

CIRCUIT LAYOUT CONSIDERATIONS

To achieve the levels of high performance of the TLV247x, follow proper printed circuit board (PCB) design techniques. A general set of guidelines is given below:

- **Ground planes**—It is highly recommended that a ground plane be used on the board to provide all components with a low inductive ground connection. However, in the areas of the amplifier inputs and output, the ground plane can be removed to minimize the stray capacitance.
- **Proper power supply decoupling**—Use a $6.8\mu\text{F}$ tantalum capacitor in parallel with a $0.1\mu\text{F}$ ceramic capacitor on each supply terminal. It may be possible to share the tantalum among several amplifiers depending on the application, but a $0.1\mu\text{F}$ ceramic capacitor should always be used on the supply terminal of every amplifier. In addition, the $0.1\mu\text{F}$ capacitor should be placed as close as possible to the supply terminal. As this distance increases, the inductance in the connecting trace makes the capacitor less effective. The designer should strive for distances of less than 0.1 inches between the device power terminals and the ceramic capacitors.
- **Sockets**—Sockets can be used but are not recommended. The additional lead inductance in the socket pins will often lead to stability problems. Surface-mount packages soldered directly to the printed-circuit board is the best implementation.
- **Short trace runs/compact part placements**—Optimum high performance is achieved when stray series inductance has been minimized. To realize this, the circuit layout should be made as compact as possible, thereby minimizing the length of all trace runs. Particular attention should be paid to the inverting input of the amplifier. Its length should be kept as short as possible. This will help to minimize stray capacitance at the input of the amplifier.
- **Surface-mount passive components**—Using surface-mount passive components is recommended for high-performance amplifier circuits for several reasons. First, because of the extremely low lead inductance of surface-mount components, the problem with stray series inductance is greatly reduced. Second, the small size of surface-mount components naturally leads to a more compact layout thereby minimizing both stray inductance and capacitance. If leaded components are used, it is recommended that the lead lengths be kept as short as possible.

GENERAL PowerPAD™ DESIGN CONSIDERATIONS

The TLV247x is available in a thermally-enhanced PowerPAD family of packages. These packages are constructed using a downset leadframe upon which the die is mounted (see Figure 46a and Figure 46b). This arrangement results in the lead frame being exposed as a thermal pad on the underside of the package (see Figure 46c). Because this thermal pad has direct thermal contact with the die, excellent thermal performance can be achieved by providing a good thermal path away from the thermal pad.

The PowerPAD package allows for both assembly and thermal management in one manufacturing operation. During the surface-mount solder operation (when the leads are being soldered), the thermal pad must be soldered to a copper area underneath the package. Through the use of thermal paths within this copper area, heat can be conducted away from the package into either a ground plane or other heat dissipating device.

Soldering the PowerPAD to the PCB is always recommended, even with applications that have low power dissipation. It provides the necessary mechanical and thermal connection between the lead frame die pad and the PCB.

The PowerPAD package represents a breakthrough in combining the small area and ease of assembly of surface mount with previously awkward mechanical methods of heatsinking.

APPLICATION INFORMATION (continued)

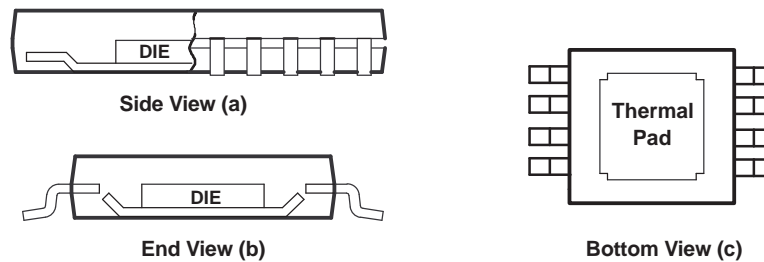

The thermal pad is electrically isolated from all terminals in the package.

Figure 46. Views of Thermally Enhanced DGN Package

Although there are many ways to properly heatsink the PowerPAD package, the following steps illustrate the recommended approach.

1. The thermal pad must be connected to the most negative supply voltage on the device (GND pin).
2. Prepare the PCB with a top side etch pattern as illustrated in the thermal land pattern mechanical drawing at the end of this document. There should be etch for the leads as well as etch for the thermal pad.
3. Place holes in the area of the thermal pad as illustrated in the land pattern mechanical drawing at the end of this document. These holes should be 13mils (0.013 inches or 0.3302mm) in diameter. Keep them small so that solder wicking through the holes is not a problem during reflow.
4. Additional vias may be placed anywhere along the thermal plane outside of the thermal pad area. This helps dissipate the heat generated by the TLV247x IC. These additional vias may be larger than the 13mil diameter vias directly under the thermal pad. They can be larger because they are not in the thermal pad area to be soldered so that wicking is not a problem.
5. Connect all holes to the internal ground plane that is at the same voltage potential as the device GND pin.
6. When connecting these holes to the ground plane, **do not** use the typical web or spoke via connection methodology. Web connections have a high thermal resistance connection that is useful for slowing the heat transfer during soldering operations. This makes the soldering of vias that have plane connections easier. In this application, however, low thermal resistance is desired for the most efficient heat transfer. Therefore, the holes under the TLV247x PowerPAD package should make their connection to the internal ground plane with a complete connection around the entire circumference of the plated-through hole.
7. The top-side solder mask should leave the terminals of the package and the thermal pad area with its holes exposed. The bottom-side solder mask should cover the holes of the thermal pad area. This prevents solder from being pulled away from the thermal pad area during the reflow process.
8. Apply solder paste to the exposed thermal pad area and all of the IC terminals.
9. With these preparatory steps in place, the TLV247x IC is simply placed in position and run through the solder reflow operation as any standard surface-mount component. This results in a part that is properly installed.

For a given θ_{JA} , the maximum power dissipation is shown in [Figure 47](#) and is calculated by [Equation 1](#):

$$P_D = \left(\frac{T_{MAX} - T_A}{\theta_{JA}} \right) \quad (1)$$

Where:

- P_D = Maximum power dissipation of TLV247x IC (watts)
- T_{MAX} = Absolute maximum junction temperature (+150°C)
- T_A = Free-ambient air temperature (°C)
- $\theta_{JA} = \theta_{JC} + \theta_{CA}$
 - θ_{JC} = Thermal coefficient from junction to case
 - θ_{CA} = Thermal coefficient from case to ambient air (°C/W)

APPLICATION INFORMATION (continued)

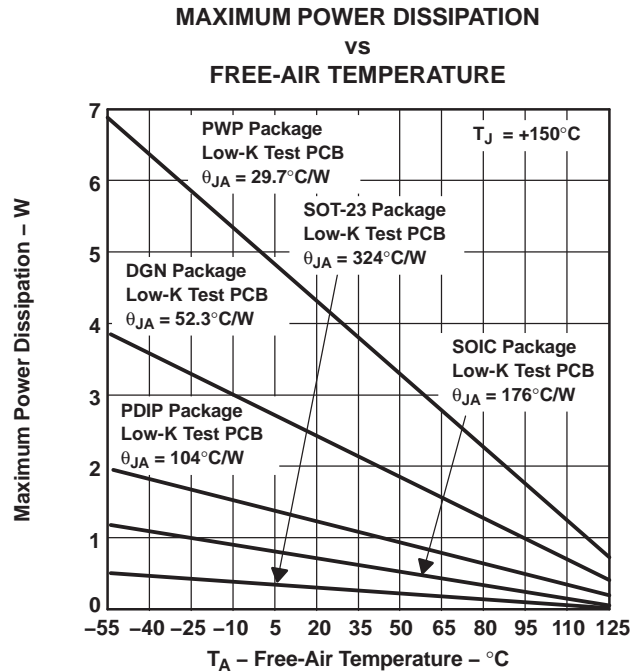

Results are obtained with no air flow and using JEDEC Standard Low-K test PCB.

Figure 47. Maximum Power Dissipation vs Free-Air Temperature

The next consideration is the package constraints. The two sources of heat within an amplifier are quiescent power and output power. The designer should never forget about the quiescent heat generated within the device, especially multi-amplifier devices. Because these devices have linear output stages (Class A-B), most of the heat dissipation is at low output voltages with high output currents. Figure 48 to Figure 53 show this effect, along with the quiescent heat, with an ambient air temperature of +70°C and +125°C. When using $V_{DD} = 3V$, there is generally not a heat problem with an ambient air temperature of +70°C. But, when using $V_{DD} = 5V$, the package is severely limited in the amount of heat it can dissipate. The other key factor when looking at these graphs is how the devices are mounted on the PCB. The PowerPAD devices are extremely useful for heat dissipation. But the device should always be soldered to a copper plane to fully use the heat dissipation properties of the PowerPAD. The SOIC package, on the other hand, is highly dependent on how it is mounted on the PCB. As more trace and copper area is placed around the device, θ_{JA} decreases and the heat dissipation capability increases. The currents and voltages shown in these graphs are for the total package. For the dual or quad amplifier packages, the sum of the RMS output currents and voltages should be used to choose the proper package.

APPLICATION INFORMATION (continued)

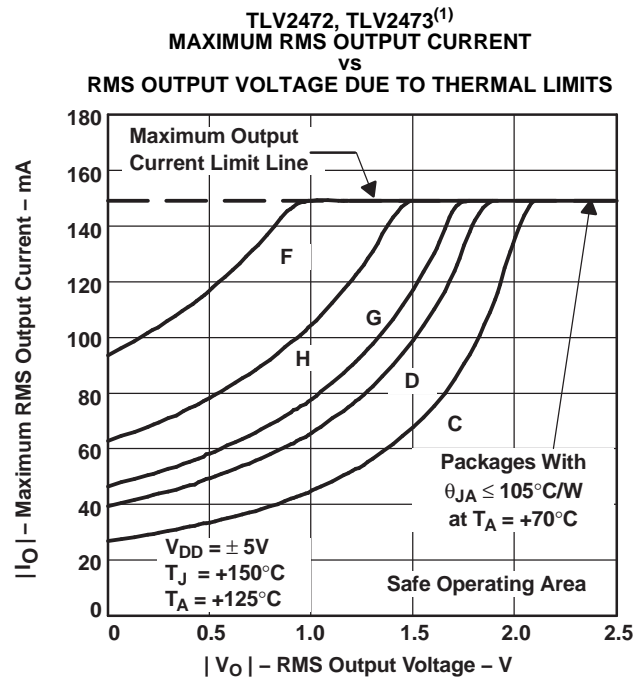
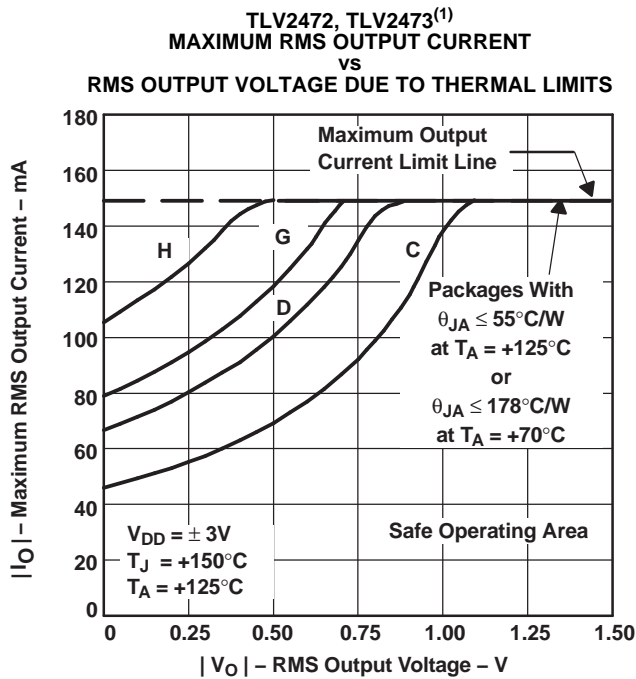
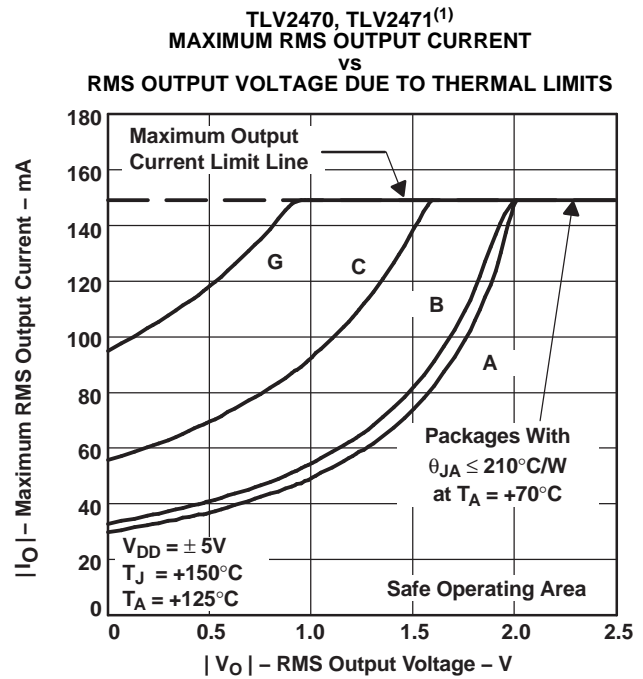
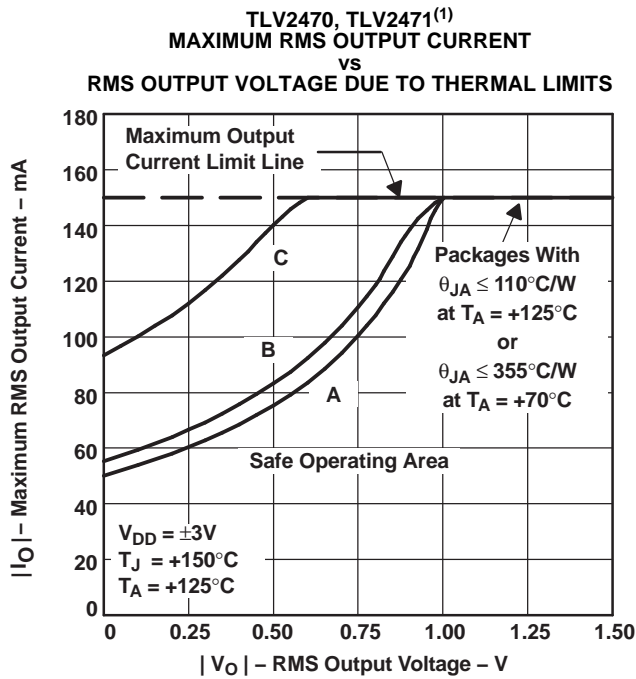

Note: (1) A - SOT23 (5); B - SOT23 (6); C - SOIC (8); D - SOIC (14); E - SOIC (16); F - MSOP PP (8); G - PDIP (8); H - PDIP (14); I - PDIP (16); J - TSSOP PP (14/16)

APPLICATION INFORMATION (continued)

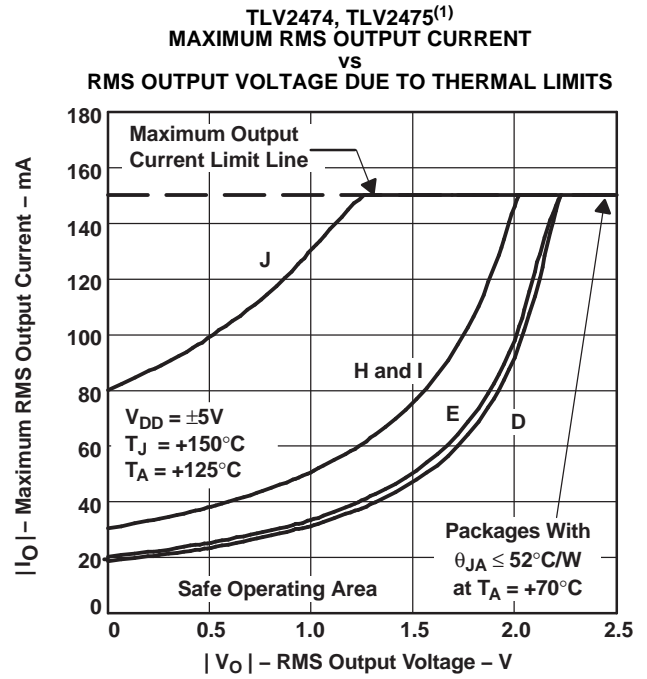
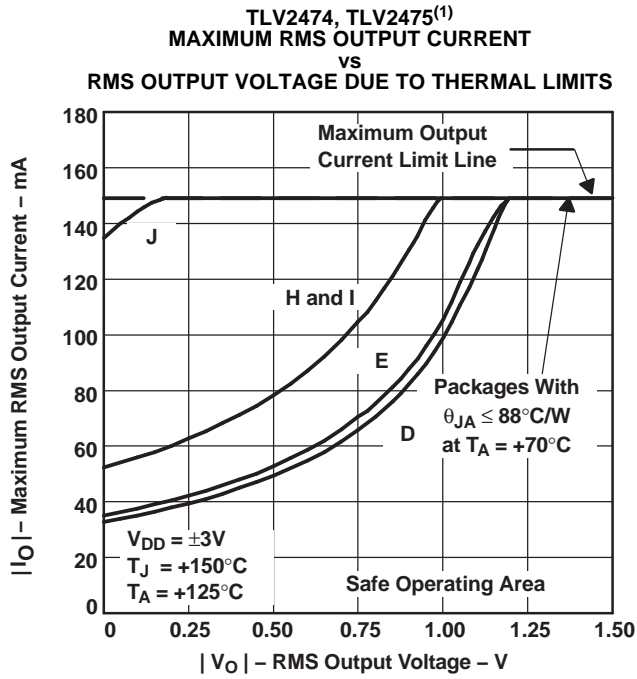

NOTE: (1) A - SOT23 (5); B - SOT23 (6); C - SOIC (8); D - SOIC (14); E - SOIC (16); F - MSOP PP (8); G - PDIP (8); H - PDIP (14); I - PDIP (16); J - TSSOP PP (14/16)

PACKAGING INFORMATION

Orderable Device	Status (1)	Package Type	Package Drawing	Pins	Package Qty	Eco Plan (2)	Lead finish/ Ball material (6)	MSL Peak Temp (3)	Op Temp (°C)	Device Marking (4/5)	Samples
TLV2470AID	ACTIVE	SOIC	D	8	75	RoHS & Green	NIPDAU	Level-1-260C-UNLIM	-40 to 125	2470AI	Samples
TLV2470AIP	ACTIVE	PDIP	P	8	50	RoHS & Green	NIPDAU	N / A for Pkg Type	-40 to 125	TLV2470AI	Samples
TLV2470CD	ACTIVE	SOIC	D	8	75	RoHS & Green	NIPDAU	Level-1-260C-UNLIM	0 to 70	2470C	Samples
TLV2470CDBVR	ACTIVE	SOT-23	DBV	6	3000	RoHS & Green	NIPDAU	Level-1-260C-UNLIM	0 to 70	VAUC	Samples
TLV2470CDBVT	ACTIVE	SOT-23	DBV	6	250	RoHS & Green	NIPDAU	Level-1-260C-UNLIM	0 to 70	VAUC	Samples
TLV2470CDR	ACTIVE	SOIC	D	8	2500	RoHS & Green	NIPDAU	Level-1-260C-UNLIM	0 to 70	2470C	Samples
TLV2470CDRG4	ACTIVE	SOIC	D	8	2500	RoHS & Green	NIPDAU	Level-1-260C-UNLIM	0 to 70	2470C	Samples
TLV2470CP	ACTIVE	PDIP	P	8	50	RoHS & Green	NIPDAU	N / A for Pkg Type	0 to 70	TLV2470C	Samples
TLV2470ID	ACTIVE	SOIC	D	8	75	RoHS & Green	NIPDAU	Level-1-260C-UNLIM	-40 to 125	2470I	Samples
TLV2470IDBVR	ACTIVE	SOT-23	DBV	6	3000	RoHS & Green	NIPDAU	Level-1-260C-UNLIM	-40 to 125	VAUI	Samples
TLV2470IDBVT	ACTIVE	SOT-23	DBV	6	250	RoHS & Green	NIPDAU	Level-1-260C-UNLIM	-40 to 125	VAUI	Samples
TLV2470IDR	ACTIVE	SOIC	D	8	2500	RoHS & Green	NIPDAU	Level-1-260C-UNLIM	-40 to 125	2470I	Samples
TLV2471AID	ACTIVE	SOIC	D	8	75	RoHS & Green	NIPDAU	Level-1-260C-UNLIM	-40 to 125	2471AI	Samples
TLV2471AIDR	ACTIVE	SOIC	D	8	2500	RoHS & Green	NIPDAU	Level-1-260C-UNLIM	-40 to 125	2471AI	Samples
TLV2471AIP	ACTIVE	PDIP	P	8	50	RoHS & Green	NIPDAU	N / A for Pkg Type	-40 to 125	TLV2471AI	Samples
TLV2471CD	ACTIVE	SOIC	D	8	75	RoHS & Green	NIPDAU	Level-1-260C-UNLIM	0 to 70	2471C	Samples
TLV2471CDBVR	ACTIVE	SOT-23	DBV	5	3000	RoHS & Green	NIPDAU	Level-1-260C-UNLIM	0 to 70	VAVC	Samples
TLV2471CDBVRG4	ACTIVE	SOT-23	DBV	5	3000	RoHS & Green	NIPDAU	Level-1-260C-UNLIM	0 to 70	VAVC	Samples
TLV2471CDBVT	ACTIVE	SOT-23	DBV	5	250	RoHS & Green	NIPDAU	Level-1-260C-UNLIM	0 to 70	VAVC	Samples
TLV2471CDBVTG4	ACTIVE	SOT-23	DBV	5	250	RoHS & Green	NIPDAU	Level-1-260C-UNLIM	0 to 70	VAVC	Samples

Orderable Device	Status (1)	Package Type	Package Drawing	Pins	Package Qty	Eco Plan (2)	Lead finish/ Ball material (6)	MSL Peak Temp (3)	Op Temp (°C)	Device Marking (4/5)	Samples
TLV2471CDR	ACTIVE	SOIC	D	8	2500	RoHS & Green	NIPDAU	Level-1-260C-UNLIM	0 to 70	2471C	Samples
TLV2471CP	ACTIVE	PDIP	P	8	50	RoHS & Green	NIPDAU	N / A for Pkg Type	0 to 70	TLV2471C	Samples
TLV2471ID	ACTIVE	SOIC	D	8	75	RoHS & Green	NIPDAU	Level-1-260C-UNLIM	-40 to 125	2471I	Samples
TLV2471IDBVR	ACTIVE	SOT-23	DBV	5	3000	RoHS & Green	NIPDAU	Level-1-260C-UNLIM	-40 to 125	VAVI	Samples
TLV2471IDBVRG4	ACTIVE	SOT-23	DBV	5	3000	RoHS & Green	NIPDAU	Level-1-260C-UNLIM	-40 to 125	VAVI	Samples
TLV2471IDBVT	ACTIVE	SOT-23	DBV	5	250	RoHS & Green	NIPDAU	Level-1-260C-UNLIM	-40 to 125	VAVI	Samples
TLV2471IDBVTG4	ACTIVE	SOT-23	DBV	5	250	RoHS & Green	NIPDAU	Level-1-260C-UNLIM	-40 to 125	VAVI	Samples
TLV2471IDR	ACTIVE	SOIC	D	8	2500	RoHS & Green	NIPDAU	Level-1-260C-UNLIM	-40 to 125	2471I	Samples
TLV2471IP	ACTIVE	PDIP	P	8	50	RoHS & Green	NIPDAU	N / A for Pkg Type	-40 to 125	TLV2471I	Samples
TLV2472AID	ACTIVE	SOIC	D	8	75	RoHS & Green	NIPDAU	Level-1-260C-UNLIM	-40 to 125	2472AI	Samples
TLV2472AIDG4	ACTIVE	SOIC	D	8	75	RoHS & Green	NIPDAU	Level-1-260C-UNLIM	-40 to 125	2472AI	Samples
TLV2472AIDR	ACTIVE	SOIC	D	8	2500	RoHS & Green	NIPDAU	Level-1-260C-UNLIM	-40 to 125	2472AI	Samples
TLV2472AIP	ACTIVE	PDIP	P	8	50	RoHS & Green	NIPDAU	N / A for Pkg Type	-40 to 125	TLV2472AI	Samples
TLV2472CD	ACTIVE	SOIC	D	8	75	RoHS & Green	NIPDAU	Level-1-260C-UNLIM	0 to 70	2472C	Samples
TLV2472CDGN	ACTIVE	HVSSOP	DGN	8	80	RoHS & Green	NIPDAU	Level-1-260C-UNLIM	0 to 70	ABU	Samples
TLV2472CDGNR	ACTIVE	HVSSOP	DGN	8	2500	RoHS & Green	NIPDAU	Level-1-260C-UNLIM	0 to 70	ABU	Samples
TLV2472CDGNRG4	ACTIVE	HVSSOP	DGN	8	2500	RoHS & Green	NIPDAU	Level-1-260C-UNLIM	0 to 70	ABU	Samples
TLV2472CDR	ACTIVE	SOIC	D	8	2500	RoHS & Green	NIPDAU	Level-1-260C-UNLIM	0 to 70	2472C	Samples
TLV2472CP	ACTIVE	PDIP	P	8	50	RoHS & Green	NIPDAU	N / A for Pkg Type	0 to 70	TLV2472CP	Samples
TLV2472ID	ACTIVE	SOIC	D	8	75	RoHS & Green	NIPDAU	Level-1-260C-UNLIM	-40 to 125	2472I	Samples
TLV2472IDGN	ACTIVE	HVSSOP	DGN	8	80	RoHS & Green	NIPDAU	Level-1-260C-UNLIM	-40 to 125	ABV	Samples

Orderable Device	Status (1)	Package Type	Package Drawing	Pins	Package Qty	Eco Plan (2)	Lead finish/ Ball material (6)	MSL Peak Temp (3)	Op Temp (°C)	Device Marking (4/5)	Samples
TLV2472IDGNG4	ACTIVE	HVSSOP	DGN	8	80	RoHS & Green	NIPDAU	Level-1-260C-UNLIM	-40 to 125	ABV	Samples
TLV2472IDGNR	ACTIVE	HVSSOP	DGN	8	2500	RoHS & Green	NIPDAU	Level-1-260C-UNLIM	-40 to 125	ABV	Samples
TLV2472IDGNRG4	ACTIVE	HVSSOP	DGN	8	2500	RoHS & Green	NIPDAU	Level-1-260C-UNLIM	-40 to 125	ABV	Samples
TLV2472IDR	ACTIVE	SOIC	D	8	2500	RoHS & Green	NIPDAU	Level-1-260C-UNLIM	-40 to 125	2472I	Samples
TLV2472IP	ACTIVE	PDIP	P	8	50	RoHS & Green	NIPDAU	N / A for Pkg Type	-40 to 125	TLV2472IP	Samples
TLV2473AID	ACTIVE	SOIC	D	14	50	RoHS & Green	NIPDAU	Level-1-260C-UNLIM	-40 to 125	TLV2473AI	Samples
TLV2473AIDR	ACTIVE	SOIC	D	14	2500	RoHS & Green	NIPDAU	Level-1-260C-UNLIM	-40 to 125	TLV2473AI	Samples
TLV2473AIN	ACTIVE	PDIP	N	14	25	RoHS & Green	NIPDAU	N / A for Pkg Type	-40 to 125	TLV2473AIN	Samples
TLV2473CD	ACTIVE	SOIC	D	14	50	RoHS & Green	NIPDAU	Level-1-260C-UNLIM	0 to 70	TLV2473C	Samples
TLV2473CDGQR	ACTIVE	HVSSOP	DGQ	10	2500	RoHS & Green	NIPDAU NIPDAUAG	Level-1-260C-UNLIM	0 to 70	ABW	Samples
TLV2473CDR	ACTIVE	SOIC	D	14	2500	RoHS & Green	NIPDAU	Level-1-260C-UNLIM	0 to 70	TLV2473C	Samples
TLV2473IDGQR	ACTIVE	HVSSOP	DGQ	10	2500	RoHS & Green	NIPDAU	Level-1-260C-UNLIM	-40 to 125	ABX	Samples
TLV2473IN	ACTIVE	PDIP	N	14	25	RoHS & Green	NIPDAU	N / A for Pkg Type	-40 to 125	TLV2473IN	Samples
TLV2474AID	ACTIVE	SOIC	D	14	50	RoHS & Green	NIPDAU	Level-1-260C-UNLIM	-40 to 125	2474AI	Samples
TLV2474AIDR	ACTIVE	SOIC	D	14	2500	RoHS & Green	NIPDAU	Level-1-260C-UNLIM	-40 to 125	2474AI	Samples
TLV2474AIN	ACTIVE	PDIP	N	14	25	RoHS & Green	NIPDAU	N / A for Pkg Type	-40 to 125	TLV2474AI	Samples
TLV2474AINE4	ACTIVE	PDIP	N	14	25	RoHS & Green	NIPDAU	N / A for Pkg Type	-40 to 125	TLV2474AI	Samples
TLV2474AIPWP	ACTIVE	HTSSOP	PWP	14	90	RoHS & Green	NIPDAU	Level-2-260C-1 YEAR	-40 to 125	2474AI	Samples
TLV2474AIPWPR	ACTIVE	HTSSOP	PWP	14	2000	RoHS & Green	NIPDAU	Level-2-260C-1 YEAR	-40 to 125	2474AI	Samples
TLV2474AIPWR	ACTIVE	TSSOP	PW	14	2000	RoHS & Green	NIPDAU	Level-1-260C-UNLIM	-40 to 125	2474AI	Samples
TLV2474CD	ACTIVE	SOIC	D	14	50	RoHS & Green	NIPDAU	Level-1-260C-UNLIM	0 to 70	2474C	Samples

Orderable Device	Status (1)	Package Type	Package Drawing	Pins	Package Qty	Eco Plan (2)	Lead finish/ Ball material (6)	MSL Peak Temp (3)	Op Temp (°C)	Device Marking (4/5)	Samples
TLV2474CDR	ACTIVE	SOIC	D	14	2500	RoHS & Green	NIPDAU	Level-1-260C-UNLIM	0 to 70	2474C	Samples
TLV2474CDRG4	ACTIVE	SOIC	D	14	2500	RoHS & Green	NIPDAU	Level-1-260C-UNLIM	0 to 70	2474C	Samples
TLV2474CN	ACTIVE	PDIP	N	14	25	RoHS & Green	NIPDAU	N / A for Pkg Type	0 to 70	TLV2474C	Samples
TLV2474CPWP	ACTIVE	HTSSOP	PWP	14	90	RoHS & Green	NIPDAU	Level-2-260C-1 YEAR	0 to 70	2474C	Samples
TLV2474CPWPR	ACTIVE	HTSSOP	PWP	14	2000	RoHS & Green	NIPDAU	Level-2-260C-1 YEAR	0 to 70	2474C	Samples
TLV2474ID	ACTIVE	SOIC	D	14	50	RoHS & Green	NIPDAU	Level-1-260C-UNLIM	-40 to 125	2474I	Samples
TLV2474IDR	ACTIVE	SOIC	D	14	2500	RoHS & Green	NIPDAU	Level-1-260C-UNLIM	-40 to 125	2474I	Samples
TLV2474IN	ACTIVE	PDIP	N	14	25	RoHS & Green	NIPDAU	N / A for Pkg Type	-40 to 125	TLV2474I	Samples
TLV2474IPWP	ACTIVE	HTSSOP	PWP	14	90	RoHS & Green	NIPDAU	Level-2-260C-1 YEAR	-40 to 125	2474I	Samples
TLV2474IPWPR	ACTIVE	HTSSOP	PWP	14	2000	RoHS & Green	NIPDAU	Level-2-260C-1 YEAR	-40 to 125	2474I	Samples
TLV2475AIDR	ACTIVE	SOIC	D	16	2500	RoHS & Green	NIPDAU	Level-1-260C-UNLIM	-40 to 125	TLV2475AI	Samples
TLV2475AIN	ACTIVE	PDIP	N	16	25	RoHS & Green	NIPDAU	N / A for Pkg Type	-40 to 125	TLV2475AI	Samples
TLV2475AIPWP	ACTIVE	HTSSOP	PWP	16	90	RoHS & Green	NIPDAU	Level-2-260C-1 YEAR	-40 to 125	2475AI	Samples
TLV2475AIPWPR	ACTIVE	HTSSOP	PWP	16	2000	RoHS & Green	NIPDAU	Level-2-260C-1 YEAR	-40 to 125	2475AI	Samples
TLV2475CD	ACTIVE	SOIC	D	16	40	RoHS & Green	NIPDAU	Level-1-260C-UNLIM	0 to 70	TLV2475C	Samples
TLV2475CDR	ACTIVE	SOIC	D	16	2500	RoHS & Green	NIPDAU	Level-1-260C-UNLIM	0 to 70	TLV2475C	Samples
TLV2475CN	ACTIVE	PDIP	N	16	25	RoHS & Green	NIPDAU	N / A for Pkg Type	0 to 70	TLV2475C	Samples
TLV2475CPWPR	ACTIVE	HTSSOP	PWP	16	2000	RoHS & Green	NIPDAU	Level-2-260C-1 YEAR	0 to 70	2475C	Samples
TLV2475IPWPR	ACTIVE	HTSSOP	PWP	16	2000	RoHS & Green	NIPDAU	Level-2-260C-1 YEAR	-40 to 125	2475I	Samples

(1) The marketing status values are defined as follows:

ACTIVE: Product device recommended for new designs.

LIFEBUY: TI has announced that the device will be discontinued, and a lifetime-buy period is in effect.

NRND: Not recommended for new designs. Device is in production to support existing customers, but TI does not recommend using this part in a new design.

PREVIEW: Device has been announced but is not in production. Samples may or may not be available.

OBSOLETE: TI has discontinued the production of the device.

⁽²⁾ **RoHS:** TI defines "RoHS" to mean semiconductor products that are compliant with the current EU RoHS requirements for all 10 RoHS substances, including the requirement that RoHS substance do not exceed 0.1% by weight in homogeneous materials. Where designed to be soldered at high temperatures, "RoHS" products are suitable for use in specified lead-free processes. TI may reference these types of products as "Pb-Free".

RoHS Exempt: TI defines "RoHS Exempt" to mean products that contain lead but are compliant with EU RoHS pursuant to a specific EU RoHS exemption.

Green: TI defines "Green" to mean the content of Chlorine (Cl) and Bromine (Br) based flame retardants meet JS709B low halogen requirements of <=1000ppm threshold. Antimony trioxide based flame retardants must also meet the <=1000ppm threshold requirement.

⁽³⁾ **MSL, Peak Temp.** - The Moisture Sensitivity Level rating according to the JEDEC industry standard classifications, and peak solder temperature.

⁽⁴⁾ There may be additional marking, which relates to the logo, the lot trace code information, or the environmental category on the device.

⁽⁵⁾ Multiple Device Markings will be inside parentheses. Only one Device Marking contained in parentheses and separated by a "~" will appear on a device. If a line is indented then it is a continuation of the previous line and the two combined represent the entire Device Marking for that device.

⁽⁶⁾ **Lead finish/Ball material** - Orderable Devices may have multiple material finish options. Finish options are separated by a vertical ruled line. Lead finish/Ball material values may wrap to two lines if the finish value exceeds the maximum column width.

Important Information and Disclaimer:The information provided on this page represents TI's knowledge and belief as of the date that it is provided. TI bases its knowledge and belief on information provided by third parties, and makes no representation or warranty as to the accuracy of such information. Efforts are underway to better integrate information from third parties. TI has taken and continues to take reasonable steps to provide representative and accurate information but may not have conducted destructive testing or chemical analysis on incoming materials and chemicals. TI and TI suppliers consider certain information to be proprietary, and thus CAS numbers and other limited information may not be available for release.

In no event shall TI's liability arising out of such information exceed the total purchase price of the TI part(s) at issue in this document sold by TI to Customer on an annual basis.

OTHER QUALIFIED VERSIONS OF TLV2471, TLV2471A, TLV2472, TLV2472A, TLV2474, TLV2474A :

- Automotive : [TLV2471-Q1](#), [TLV2471A-Q1](#), [TLV2472-Q1](#), [TLV2472A-Q1](#), [TLV2474-Q1](#), [TLV2474A-Q1](#)

NOTE: Qualified Version Definitions:

- Automotive - Q100 devices qualified for high-reliability automotive applications targeting zero defects

TAPE AND REEL INFORMATION

QUADRANT ASSIGNMENTS FOR PIN 1 ORIENTATION IN TAPE

*All dimensions are nominal

Device	Package Type	Package Drawing	Pins	SPQ	Reel Diameter (mm)	Reel Width W1 (mm)	A0 (mm)	B0 (mm)	K0 (mm)	P1 (mm)	W (mm)	Pin1 Quadrant
TLV2470CDBVR	SOT-23	DBV	6	3000	178.0	9.0	3.23	3.17	1.37	4.0	8.0	Q3
TLV2470CDBVT	SOT-23	DBV	6	250	178.0	9.0	3.23	3.17	1.37	4.0	8.0	Q3
TLV2470CDR	SOIC	D	8	2500	330.0	12.4	6.4	5.2	2.1	8.0	12.0	Q1
TLV2470IDBVR	SOT-23	DBV	6	3000	178.0	9.0	3.23	3.17	1.37	4.0	8.0	Q3
TLV2470IDBVT	SOT-23	DBV	6	250	178.0	9.0	3.23	3.17	1.37	4.0	8.0	Q3
TLV2470IDR	SOIC	D	8	2500	330.0	12.4	6.4	5.2	2.1	8.0	12.0	Q1
TLV2471AIDR	SOIC	D	8	2500	330.0	12.4	6.4	5.2	2.1	8.0	12.0	Q1
TLV2471CDBVR	SOT-23	DBV	5	3000	180.0	9.0	3.15	3.2	1.4	4.0	8.0	Q3
TLV2471CDBVT	SOT-23	DBV	5	250	180.0	9.0	3.15	3.2	1.4	4.0	8.0	Q3
TLV2471CDR	SOIC	D	8	2500	330.0	12.4	6.4	5.2	2.1	8.0	12.0	Q1
TLV2471IDBVR	SOT-23	DBV	5	3000	180.0	9.0	3.15	3.2	1.4	4.0	8.0	Q3
TLV2471IDBVT	SOT-23	DBV	5	250	180.0	9.0	3.15	3.2	1.4	4.0	8.0	Q3
TLV2471IDR	SOIC	D	8	2500	330.0	12.4	6.4	5.2	2.1	8.0	12.0	Q1
TLV2472AIDR	SOIC	D	8	2500	330.0	12.4	6.4	5.2	2.1	8.0	12.0	Q1
TLV2472CDGNR	HVSSOP	DGN	8	2500	330.0	12.4	5.3	3.4	1.4	8.0	12.0	Q1
TLV2472CDR	SOIC	D	8	2500	330.0	12.4	6.4	5.2	2.1	8.0	12.0	Q1
TLV2472IDGNR	HVSSOP	DGN	8	2500	330.0	12.4	5.3	3.4	1.4	8.0	12.0	Q1
TLV2472IDR	SOIC	D	8	2500	330.0	12.4	6.4	5.2	2.1	8.0	12.0	Q1

Device	Package Type	Package Drawing	Pins	SPQ	Reel Diameter (mm)	Reel Width W1 (mm)	A0 (mm)	B0 (mm)	K0 (mm)	P1 (mm)	W (mm)	Pin1 Quadrant
TLV2473AIDR	SOIC	D	14	2500	330.0	16.4	6.5	9.0	2.1	8.0	16.0	Q1
TLV2473CDGQR	HVSSOP	DGQ	10	2500	330.0	12.4	5.3	3.4	1.4	8.0	12.0	Q1
TLV2473CDGQR	HVSSOP	DGQ	10	2500	330.0	12.4	5.3	3.4	1.4	8.0	12.0	Q1
TLV2473CDR	SOIC	D	14	2500	330.0	16.4	6.5	9.0	2.1	8.0	16.0	Q1
TLV2473IDGQR	HVSSOP	DGQ	10	2500	330.0	12.4	5.3	3.4	1.4	8.0	12.0	Q1
TLV2474AIDR	SOIC	D	14	2500	330.0	16.4	6.5	9.0	2.1	8.0	16.0	Q1
TLV2474AIPWPR	HTSSOP	PWP	14	2000	330.0	12.4	6.9	5.6	1.6	8.0	12.0	Q1
TLV2474AIPWR	TSSOP	PW	14	2000	330.0	12.4	6.9	5.6	1.6	8.0	12.0	Q1
TLV2474CDR	SOIC	D	14	2500	330.0	16.4	6.5	9.0	2.1	8.0	16.0	Q1
TLV2474CPWPR	HTSSOP	PWP	14	2000	330.0	12.4	6.9	5.6	1.6	8.0	12.0	Q1
TLV2474IDR	SOIC	D	14	2500	330.0	16.4	6.5	9.0	2.1	8.0	16.0	Q1
TLV2474IPWPR	HTSSOP	PWP	14	2000	330.0	12.4	6.9	5.6	1.6	8.0	12.0	Q1
TLV2475AIDR	SOIC	D	16	2500	330.0	16.4	6.5	10.3	2.1	8.0	16.0	Q1
TLV2475AIPWPR	HTSSOP	PWP	16	2000	330.0	12.4	6.9	5.6	1.6	8.0	12.0	Q1
TLV2475CDR	SOIC	D	16	2500	330.0	16.4	6.5	10.3	2.1	8.0	16.0	Q1
TLV2475CPWPR	HTSSOP	PWP	16	2000	330.0	12.4	6.9	5.6	1.6	8.0	12.0	Q1
TLV2475IPWPR	HTSSOP	PWP	16	2000	330.0	12.4	6.9	5.6	1.6	8.0	12.0	Q1

TAPE AND REEL BOX DIMENSIONS

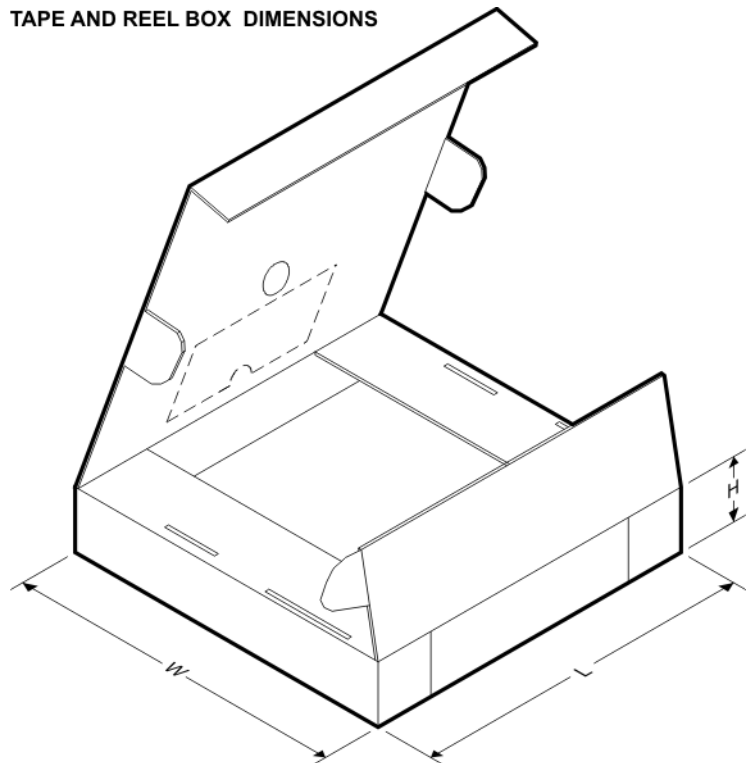

*All dimensions are nominal

Device	Package Type	Package Drawing	Pins	SPQ	Length (mm)	Width (mm)	Height (mm)
TLV2470CDBVR	SOT-23	DBV	6	3000	180.0	180.0	18.0
TLV2470CDBVT	SOT-23	DBV	6	250	180.0	180.0	18.0
TLV2470CDR	SOIC	D	8	2500	340.5	336.1	25.0
TLV2470IDBVR	SOT-23	DBV	6	3000	180.0	180.0	18.0
TLV2470IDBVT	SOT-23	DBV	6	250	180.0	180.0	18.0
TLV2470IDR	SOIC	D	8	2500	340.5	336.1	25.0
TLV2471AIDR	SOIC	D	8	2500	340.5	336.1	25.0
TLV2471CDBVR	SOT-23	DBV	5	3000	182.0	182.0	20.0
TLV2471CDBVT	SOT-23	DBV	5	250	182.0	182.0	20.0
TLV2471CDR	SOIC	D	8	2500	340.5	336.1	25.0
TLV2471IDBVR	SOT-23	DBV	5	3000	182.0	182.0	20.0
TLV2471IDBVT	SOT-23	DBV	5	250	182.0	182.0	20.0
TLV2471IDR	SOIC	D	8	2500	340.5	336.1	25.0
TLV2472AIDR	SOIC	D	8	2500	340.5	336.1	25.0
TLV2472CDGNR	HVSSOP	DGN	8	2500	358.0	335.0	35.0
TLV2472CDR	SOIC	D	8	2500	340.5	336.1	25.0
TLV2472IDGNR	HVSSOP	DGN	8	2500	358.0	335.0	35.0
TLV2472IDR	SOIC	D	8	2500	340.5	336.1	25.0
TLV2473AIDR	SOIC	D	14	2500	350.0	350.0	43.0
TLV2473CDGQR	HVSSOP	DGQ	10	2500	364.0	364.0	27.0
TLV2473CDGQR	HVSSOP	DGQ	10	2500	358.0	335.0	35.0
TLV2473CDR	SOIC	D	14	2500	350.0	350.0	43.0
TLV2473IDGQR	HVSSOP	DGQ	10	2500	358.0	335.0	35.0
TLV2474AIDR	SOIC	D	14	2500	350.0	350.0	43.0
TLV2474AIPWPR	HTSSOP	PWP	14	2000	350.0	350.0	43.0
TLV2474AIPWR	TSSOP	PW	14	2000	853.0	449.0	35.0
TLV2474CDR	SOIC	D	14	2500	350.0	350.0	43.0
TLV2474CPWPR	HTSSOP	PWP	14	2000	350.0	350.0	43.0
TLV2474IDR	SOIC	D	14	2500	350.0	350.0	43.0
TLV2474IPWPR	HTSSOP	PWP	14	2000	350.0	350.0	43.0
TLV2475AIDR	SOIC	D	16	2500	350.0	350.0	43.0
TLV2475AIPWPR	HTSSOP	PWP	16	2000	350.0	350.0	43.0
TLV2475CDR	SOIC	D	16	2500	350.0	350.0	43.0
TLV2475CPWPR	HTSSOP	PWP	16	2000	350.0	350.0	43.0
TLV2475IPWPR	HTSSOP	PWP	16	2000	350.0	350.0	43.0

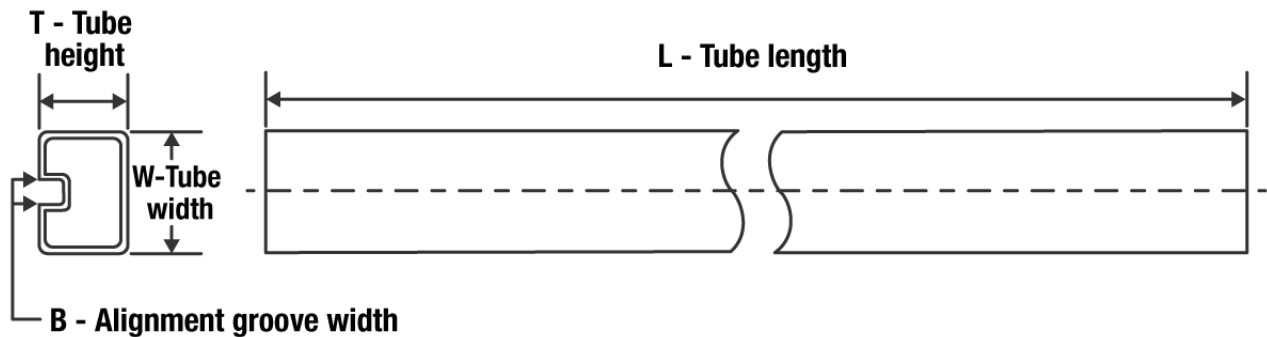
TUBE

*All dimensions are nominal

Device	Package Name	Package Type	Pins	SPQ	L (mm)	W (mm)	T (μm)	B (mm)
TLV2470AID	D	SOIC	8	75	507	8	3940	4.32
TLV2470AID	D	SOIC	8	75	505.46	6.76	3810	4
TLV2470AIP	P	PDIP	8	50	506	13.97	11230	4.32
TLV2470CD	D	SOIC	8	75	507	8	3940	4.32
TLV2470CD	D	SOIC	8	75	505.46	6.76	3810	4
TLV2470CP	P	PDIP	8	50	506	13.97	11230	4.32
TLV2470ID	D	SOIC	8	75	505.46	6.76	3810	4
TLV2470ID	D	SOIC	8	75	507	8	3940	4.32
TLV2471AID	D	SOIC	8	75	505.46	6.76	3810	4
TLV2471AID	D	SOIC	8	75	507	8	3940	4.32
TLV2471AIP	P	PDIP	8	50	506	13.97	11230	4.32
TLV2471CD	D	SOIC	8	75	505.46	6.76	3810	4
TLV2471CD	D	SOIC	8	75	507	8	3940	4.32
TLV2471CP	P	PDIP	8	50	506	13.97	11230	4.32
TLV2471ID	D	SOIC	8	75	505.46	6.76	3810	4
TLV2471ID	D	SOIC	8	75	507	8	3940	4.32
TLV2471IP	P	PDIP	8	50	506	13.97	11230	4.32
TLV2472AID	D	SOIC	8	75	507	8	3940	4.32
TLV2472AID	D	SOIC	8	75	505.46	6.76	3810	4
TLV2472AIDG4	D	SOIC	8	75	507	8	3940	4.32
TLV2472AIDG4	D	SOIC	8	75	505.46	6.76	3810	4
TLV2472AIP	P	PDIP	8	50	506	13.97	11230	4.32
TLV2472CD	D	SOIC	8	75	507	8	3940	4.32
TLV2472CD	D	SOIC	8	75	505.46	6.76	3810	4
TLV2472CP	P	PDIP	8	50	506	13.97	11230	4.32
TLV2472ID	D	SOIC	8	75	505.46	6.76	3810	4
TLV2472ID	D	SOIC	8	75	507	8	3940	4.32
TLV2472IP	P	PDIP	8	50	506	13.97	11230	4.32

Device	Package Name	Package Type	Pins	SPQ	L (mm)	W (mm)	T (μm)	B (mm)
TLV2473AID	D	SOIC	14	50	505.46	6.76	3810	4
TLV2473AIN	N	PDIP	14	25	506	13.97	11230	4.32
TLV2473CD	D	SOIC	14	50	505.46	6.76	3810	4
TLV2473IN	N	PDIP	14	25	506	13.97	11230	4.32
TLV2474AID	D	SOIC	14	50	505.46	6.76	3810	4
TLV2474AIN	N	PDIP	14	25	506	13.97	11230	4.32
TLV2474AINE4	N	PDIP	14	25	506	13.97	11230	4.32
TLV2474AIPWP	PWP	HTSSOP	14	90	530	10.2	3600	3.5
TLV2474CD	D	SOIC	14	50	505.46	6.76	3810	4
TLV2474CN	N	PDIP	14	25	506	13.97	11230	4.32
TLV2474CPWP	PWP	HTSSOP	14	90	530	10.2	3600	3.5
TLV2474ID	D	SOIC	14	50	505.46	6.76	3810	4
TLV2474IN	N	PDIP	14	25	506	13.97	11230	4.32
TLV2474IPWP	PWP	HTSSOP	14	90	530	10.2	3600	3.5
TLV2475AIN	N	PDIP	16	25	506	13.97	11230	4.32
TLV2475AIPWP	PWP	HTSSOP	16	90	530	10.2	3600	3.5
TLV2475CD	D	SOIC	16	40	505.46	6.76	3810	4
TLV2475CN	N	PDIP	16	25	506	13.97	11230	4.32



DBV0005A

PACKAGE OUTLINE

SOT-23 - 1.45 mm max height

SMALL OUTLINE TRANSISTOR



4214839/F 06/2021

NOTES:

1. All linear dimensions are in millimeters. Any dimensions in parenthesis are for reference only. Dimensioning and tolerancing per ASME Y14.5M.
2. This drawing is subject to change without notice.
3. Reference JEDEC MO-178.
4. Body dimensions do not include mold flash, protrusions, or gate burrs. Mold flash, protrusions, or gate burrs shall not exceed 0.25 mm per side.

EXAMPLE BOARD LAYOUT

DBV0005A

SOT-23 - 1.45 mm max height

SMALL OUTLINE TRANSISTOR



LAND PATTERN EXAMPLE
EXPOSED METAL SHOWN
SCALE:15X



SOLDER MASK DETAILS

4214839/F 06/2021

NOTES: (continued)

5. Publication IPC-7351 may have alternate designs.
6. Solder mask tolerances between and around signal pads can vary based on board fabrication site.

EXAMPLE STENCIL DESIGN

DBV0005A

SOT-23 - 1.45 mm max height

SMALL OUTLINE TRANSISTOR



SOLDER PASTE EXAMPLE
BASED ON 0.125 mm THICK STENCIL
SCALE:15X

4214839/F 06/2021

NOTES: (continued)

7. Laser cutting apertures with trapezoidal walls and rounded corners may offer better paste release. IPC-7525 may have alternate design recommendations.
8. Board assembly site may have different recommendations for stencil design.

D (R-PDSO-G16)

PLASTIC SMALL OUTLINE



4040047-6/M 06/11

- NOTES:
- A. All linear dimensions are in inches (millimeters).
 - B. This drawing is subject to change without notice.
 - C. Body length does not include mold flash, protrusions, or gate burrs. Mold flash, protrusions, or gate burrs shall not exceed 0.006 (0,15) each side.
 - D. Body width does not include interlead flash. Interlead flash shall not exceed 0.017 (0,43) each side.
 - E. Reference JEDEC MS-012 variation AC.

D (R-PDSO-G16)

PLASTIC SMALL OUTLINE



- NOTES:
- A. All linear dimensions are in millimeters.
 - B. This drawing is subject to change without notice.
 - C. Publication IPC-7351 is recommended for alternate designs.
 - D. Laser cutting apertures with trapezoidal walls and also rounding corners will offer better paste release. Customers should contact their board assembly site for stencil design recommendations. Refer to IPC-7525 for other stencil recommendations.
 - E. Customers should contact their board fabrication site for solder mask tolerances between and around signal pads.

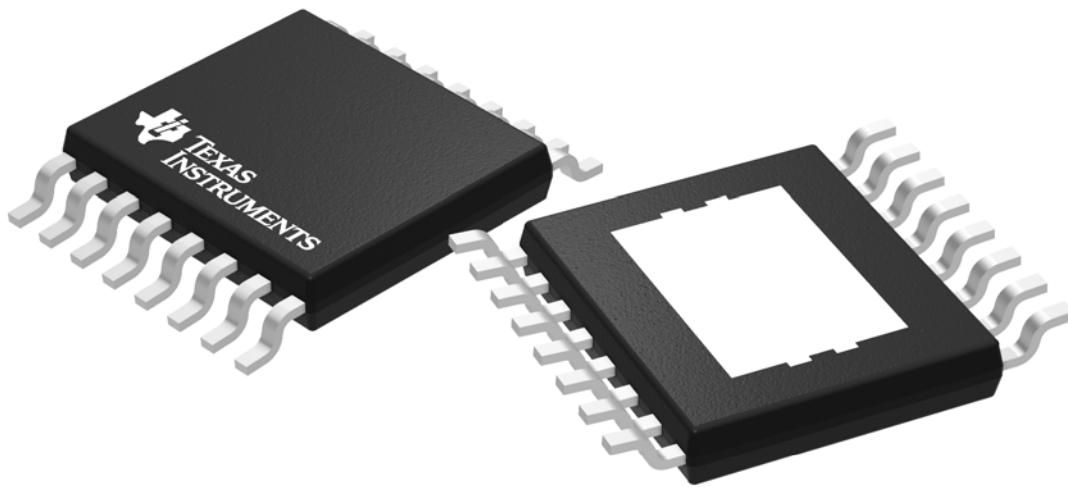

Images above are just a representation of the package family, actual package may vary.
Refer to the product data sheet for package details.

PWP0016C

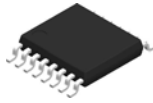

PACKAGE OUTLINE

PowerPAD™ TSSOP - 1.2 mm max height

SMALL OUTLINE PACKAGE

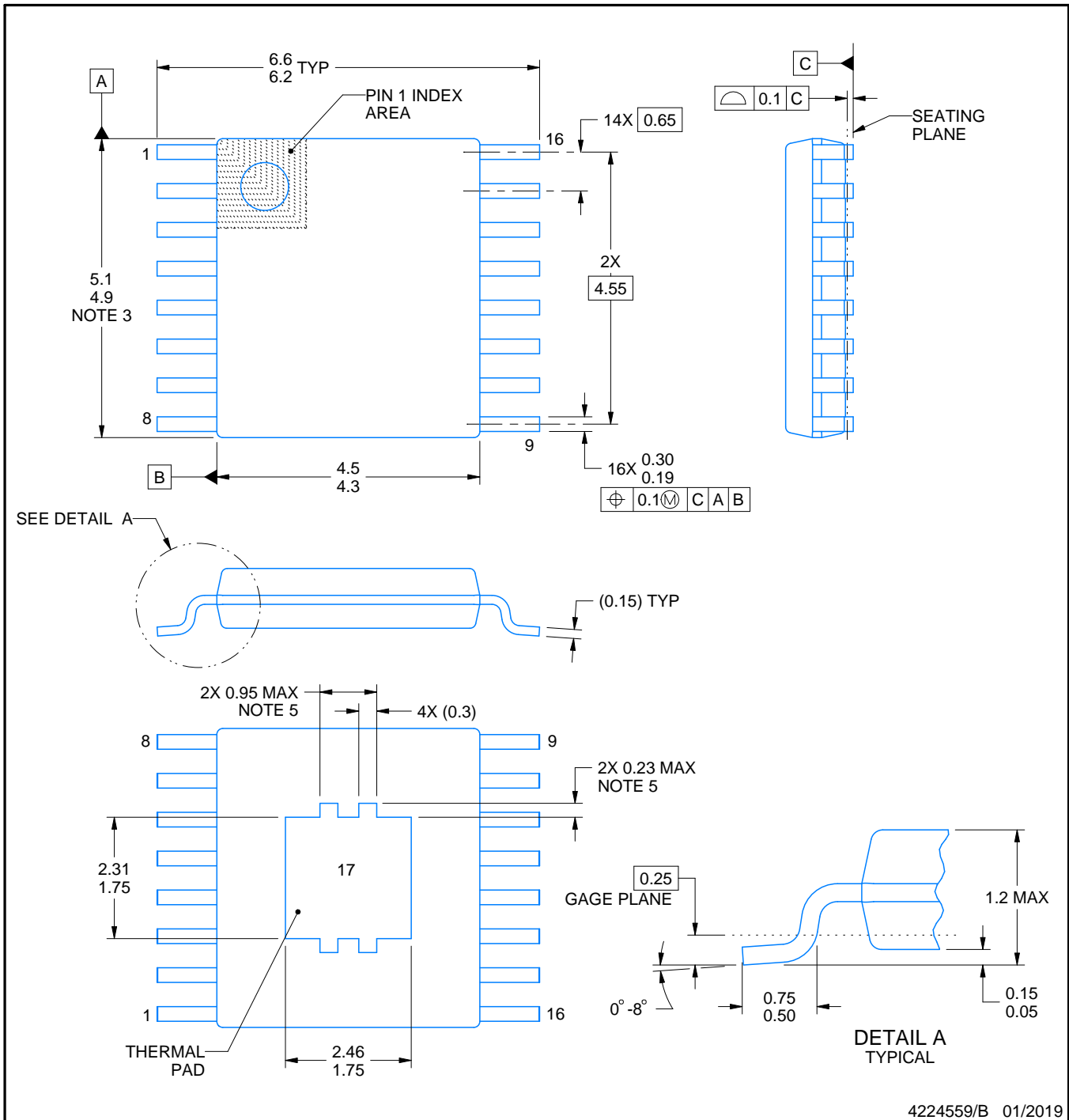

NOTES:

PowerPAD is a trademark of Texas Instruments.

1. All linear dimensions are in millimeters. Any dimensions in parenthesis are for reference only. Dimensioning and tolerancing per ASME Y14.5M.
2. This drawing is subject to change without notice.
3. This dimension does not include mold flash, protrusions, or gate burrs. Mold flash, protrusions, or gate burrs shall not exceed 0.15 mm per side.
4. Reference JEDEC registration MO-153.
5. Features may differ or may not be present.

EXAMPLE BOARD LAYOUT

PWP0016C

PowerPAD™ TSSOP - 1.2 mm max height

SMALL OUTLINE PACKAGE

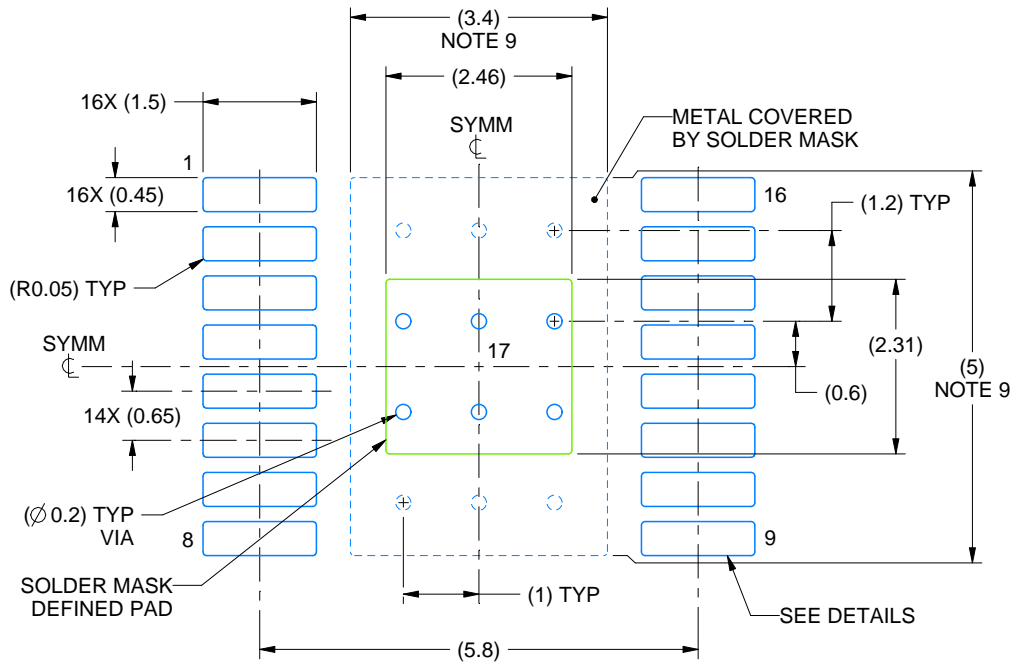

LAND PATTERN EXAMPLE
EXPOSED METAL SHOWN
SCALE: 10X

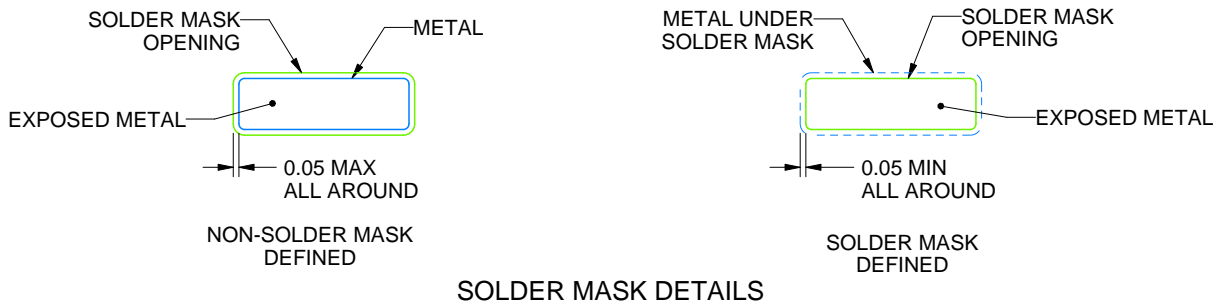

SOLDER MASK DETAILS

4224559/B 01/2019

NOTES: (continued)

6. Publication IPC-7351 may have alternate designs.
7. Solder mask tolerances between and around signal pads can vary based on board fabrication site.
8. This package is designed to be soldered to a thermal pad on the board. For more information, see Texas Instruments literature numbers SLMA002 (www.ti.com/lit/slma002) and SLMA004 (www.ti.com/lit/slma004).
9. Size of metal pad may vary due to creepage requirement.
10. Vias are optional depending on application, refer to device data sheet. It is recommended that vias under paste be filled, plugged or tented.

EXAMPLE STENCIL DESIGN

PWP0016C

PowerPAD™ TSSOP - 1.2 mm max height

SMALL OUTLINE PACKAGE

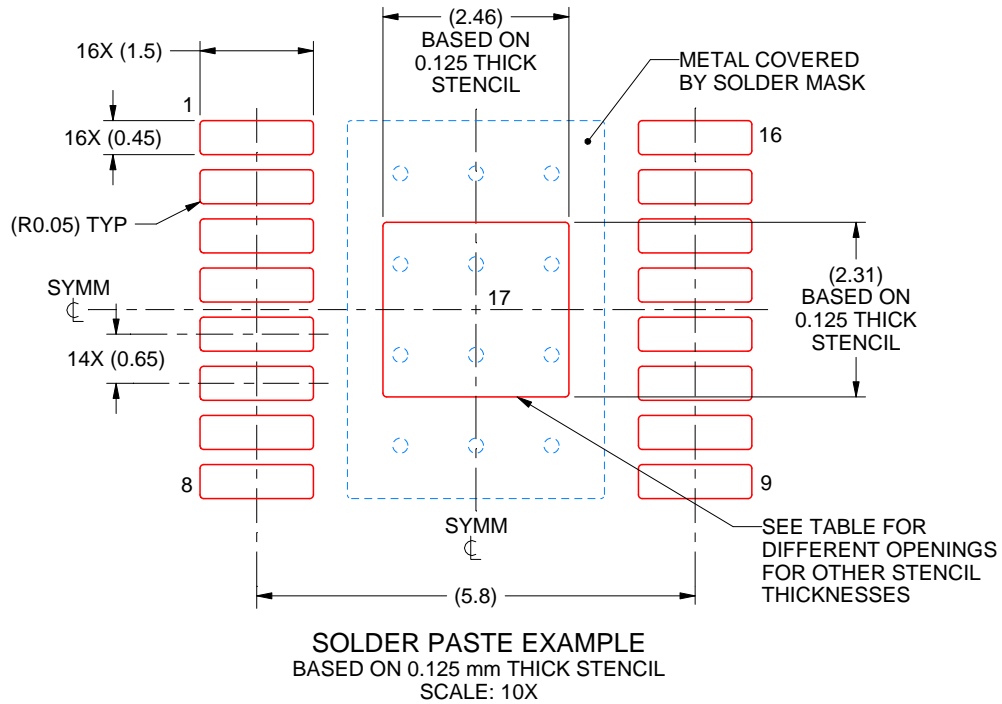

STENCIL THICKNESS	SOLDER STENCIL OPENING
0.1	2.75 X 2.58
0.125	2.46 X 2.31 (SHOWN)
0.15	2.25 X 2.11
0.175	2.08 X 1.95

4224559/B 01/2019

NOTES: (continued)

11. Laser cutting apertures with trapezoidal walls and rounded corners may offer better paste release. IPC-7525 may have alternate design recommendations.
12. Board assembly site may have different recommendations for stencil design.

GENERIC PACKAGE VIEW

DGQ 10

PowerPAD™ HVSSOP - 1.1 mm max height

3 x 3, 0.5 mm pitch

PLASTIC SMALL OUTLINE

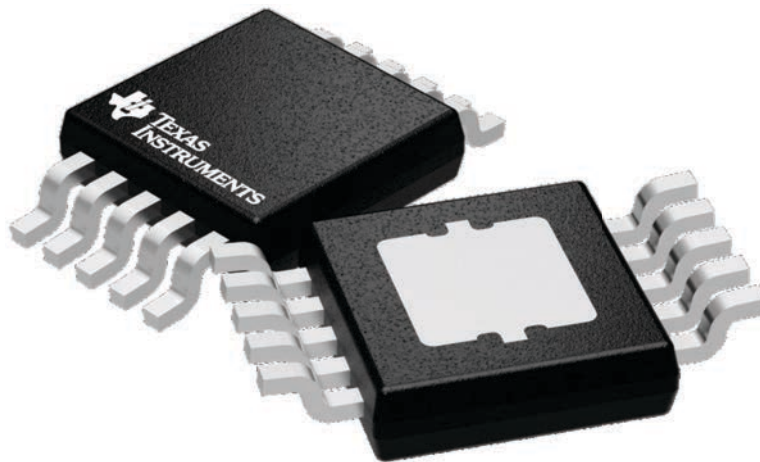

Images above are just a representation of the package family, actual package may vary.
Refer to the product data sheet for package details.

4224775/A

DGQ0010D



PACKAGE OUTLINE

PowerPAD™ - 1.1 mm max height

PLASTIC SMALL OUTLINE

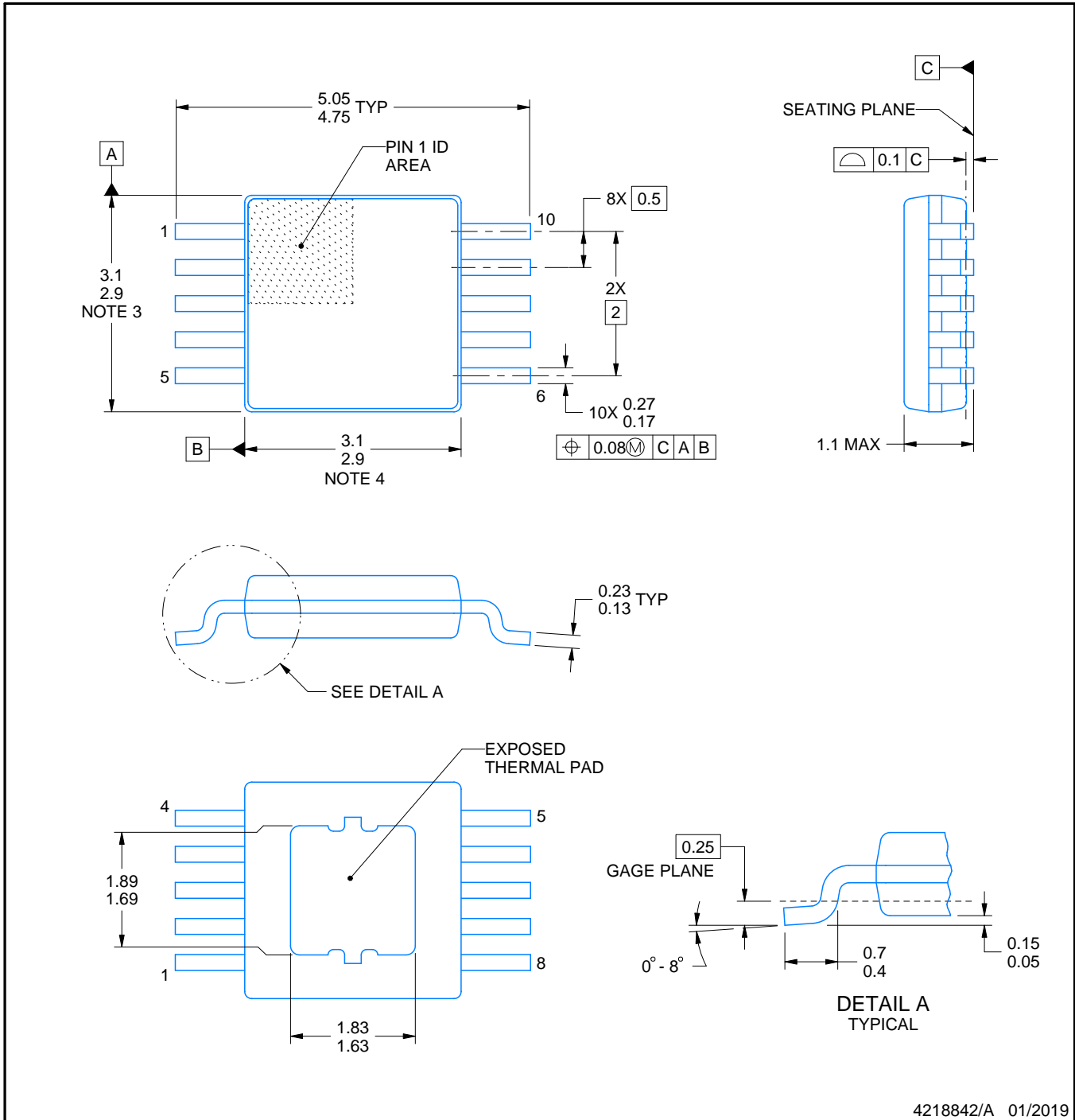

4218842/A 01/2019

PowerPAD is a trademark of Texas Instruments.

NOTES:

1. All linear dimensions are in millimeters. Any dimensions in parenthesis are for reference only. Dimensioning and tolerancing per ASME Y14.5M.
2. This drawing is subject to change without notice.
3. This dimension does not include mold flash, protrusions, or gate burrs. Mold flash, protrusions, or gate burrs shall not exceed 0.15 mm per side.
4. This dimension does not include interlead flash. Interlead flash shall not exceed 0.25 mm per side.
5. Reference JEDEC registration MO-187, variation BA-T.

EXAMPLE BOARD LAYOUT

DGQ0010D

PowerPAD™ - 1.1 mm max height

PLASTIC SMALL OUTLINE

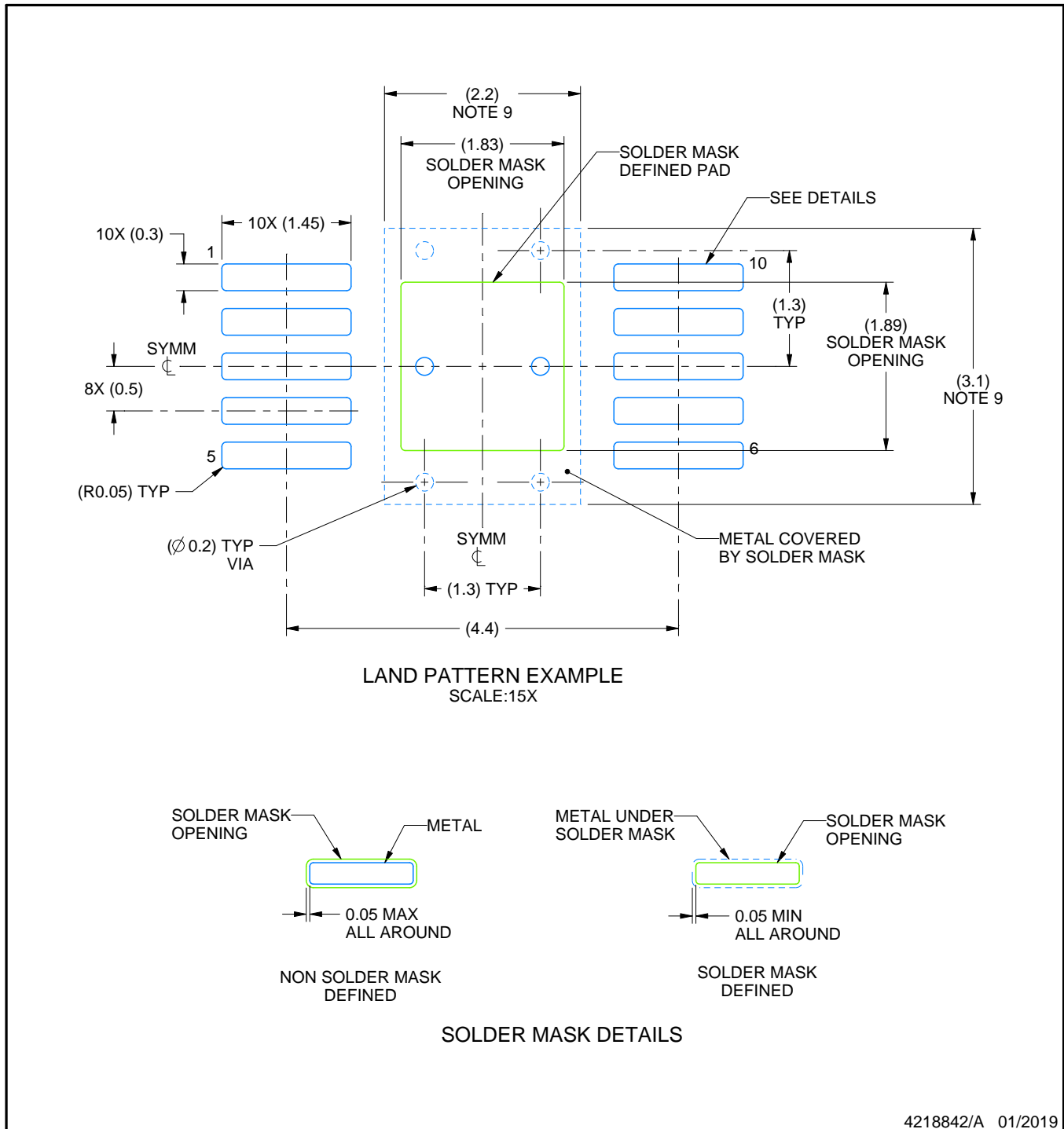

4218842/A 01/2019

NOTES: (continued)

6. Publication IPC-7351 may have alternate designs.
7. Solder mask tolerances between and around signal pads can vary based on board fabrication site.
8. This package is designed to be soldered to a thermal pad on the board. For more information, see Texas Instruments literature numbers SLMA002 (www.ti.com/lit/slma002) and SLMA004 (www.ti.com/lit/slma004).
9. Size of metal pad may vary due to creepage requirement.

EXAMPLE STENCIL DESIGN

DGQ0010D

PowerPAD™ - 1.1 mm max height

PLASTIC SMALL OUTLINE

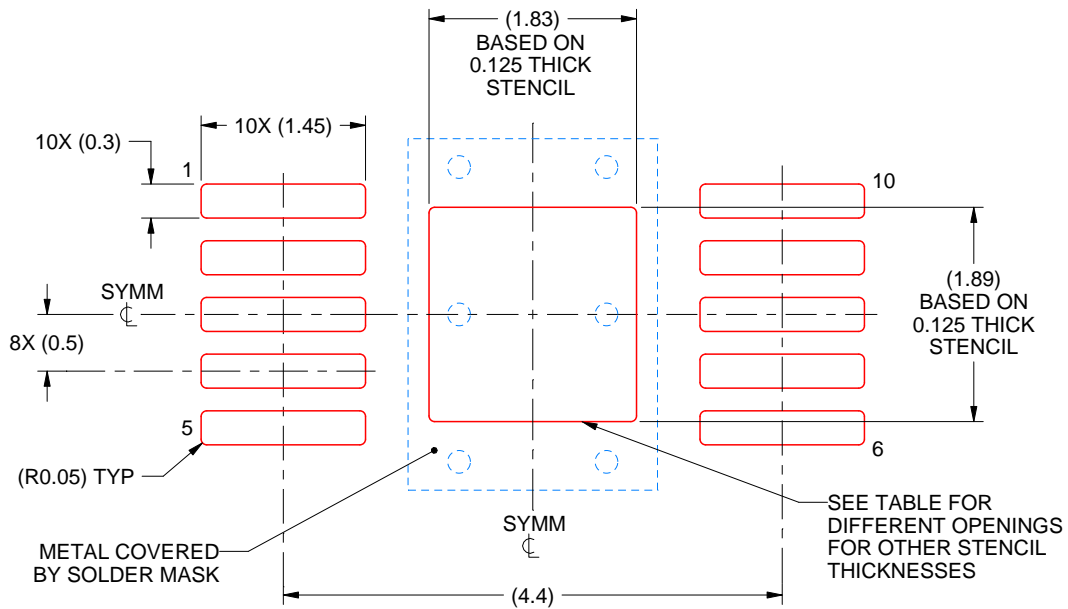

SOLDER PASTE EXAMPLE
EXPOSED PAD
100% PRINTED SOLDER COVERAGE BY AREA
SCALE:15X

STENCIL THICKNESS	SOLDER STENCIL OPENING
0.1	2.05 X 2.11
0.125	1.83 X 1.89 (SHOWN)
0.150	1.67 X 1.73
0.175	1.55 X 1.60

4218842/A 01/2019

NOTES: (continued)

10. Laser cutting apertures with trapezoidal walls and rounded corners may offer better paste release. IPC-7525 may have alternate design recommendations.
11. Board assembly site may have different recommendations for stencil design.

GENERIC PACKAGE VIEW

DGN 8

PowerPAD VSSOP - 1.1 mm max height

3 x 3, 0.65 mm pitch

SMALL OUTLINE PACKAGE

This image is a representation of the package family, actual package may vary.
Refer to the product data sheet for package details.

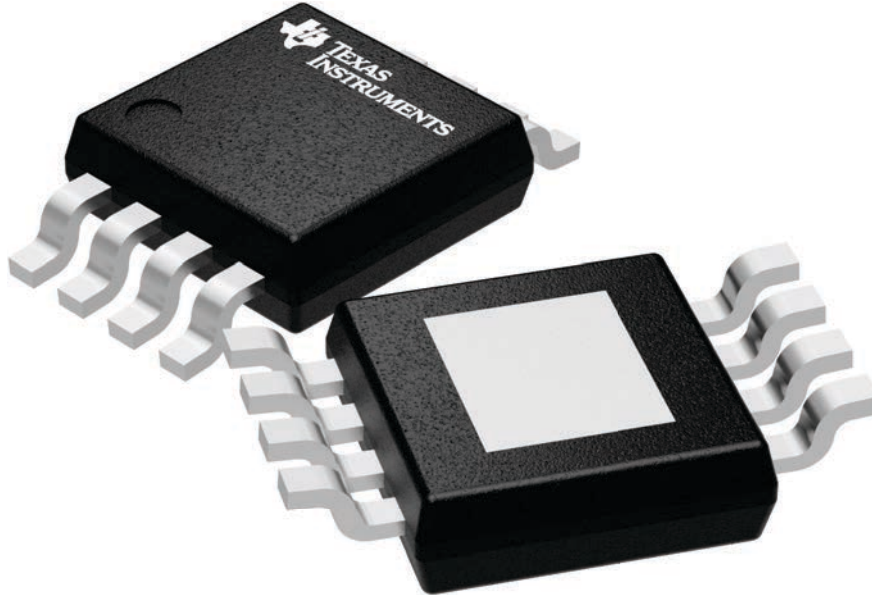

4225482/A



NOTES:

PowerPAD is a trademark of Texas Instruments.

1. All linear dimensions are in millimeters. Any dimensions in parenthesis are for reference only. Dimensioning and tolerancing per ASME Y14.5M.
2. This drawing is subject to change without notice.
3. This dimension does not include mold flash, protrusions, or gate burrs. Mold flash, protrusions, or gate burrs shall not exceed 0.15 mm per side.
4. This dimension does not include interlead flash. Interlead flash shall not exceed 0.25 mm per side.
5. Reference JEDEC registration MO-187.

EXAMPLE BOARD LAYOUT

DGN0008D

PowerPAD™ VSSOP - 1.1 mm max height

SMALL OUTLINE PACKAGE



LAND PATTERN EXAMPLE
EXPOSED METAL SHOWN
SCALE: 15X

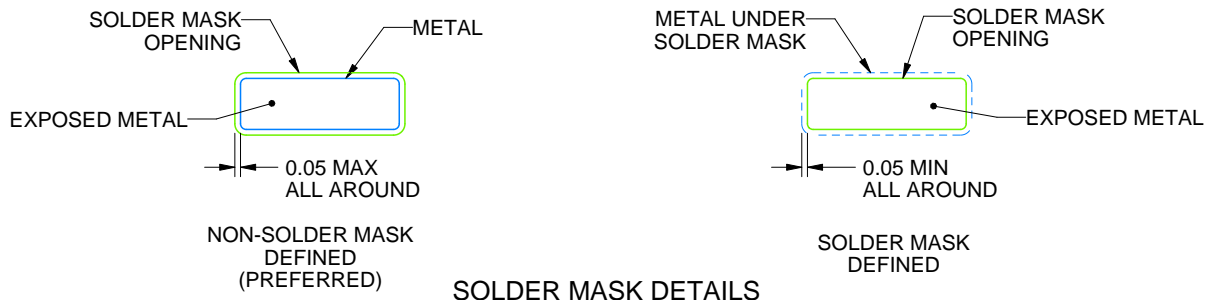

4225481/A 11/2019

NOTES: (continued)

6. Publication IPC-7351 may have alternate designs.
7. Solder mask tolerances between and around signal pads can vary based on board fabrication site.
8. Vias are optional depending on application, refer to device data sheet. If any vias are implemented, refer to their locations shown on this view. It is recommended that vias under paste be filled, plugged or tented.
9. Size of metal pad may vary due to creepage requirement.

EXAMPLE STENCIL DESIGN

DGN0008D

PowerPAD™ VSSOP - 1.1 mm max height

SMALL OUTLINE PACKAGE

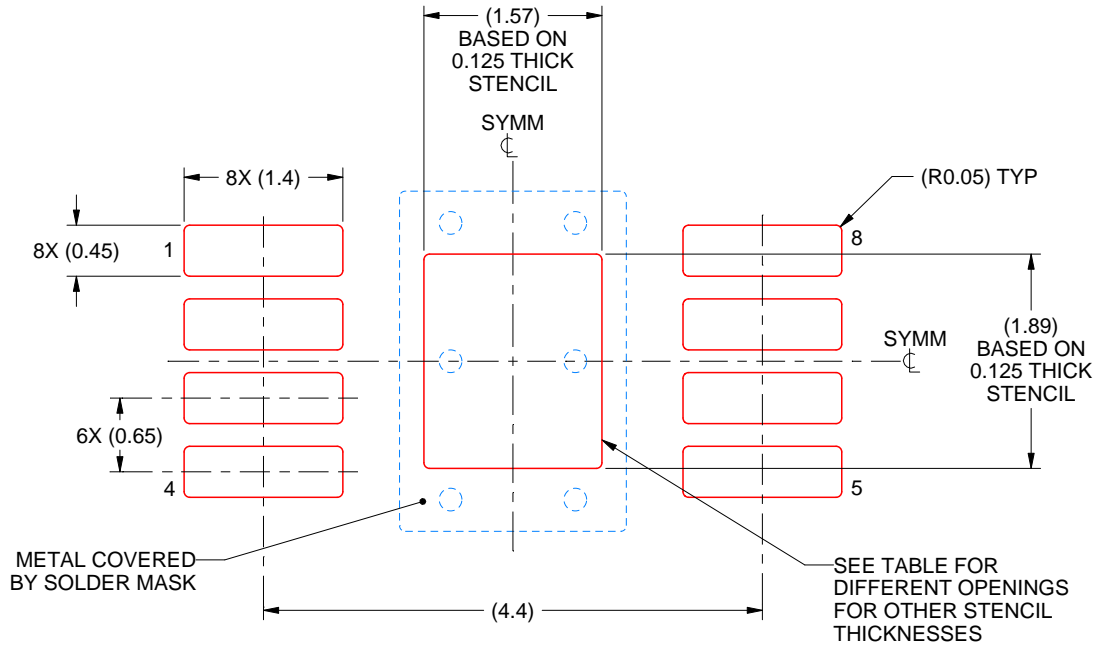

SOLDER PASTE EXAMPLE
EXPOSED PAD 9:
100% PRINTED SOLDER COVERAGE BY AREA
SCALE: 15X

STENCIL THICKNESS	SOLDER STENCIL OPENING
0.1	1.76 X 2.11
0.125	1.57 X 1.89 (SHOWN)
0.15	1.43 X 1.73
0.175	1.33 X 1.60

4225481/A 11/2019

NOTES: (continued)



10. Laser cutting apertures with trapezoidal walls and rounded corners may offer better paste release. IPC-7525 may have alternate design recommendations.
11. Board assembly site may have different recommendations for stencil design.

D (R-PDSO-G14)

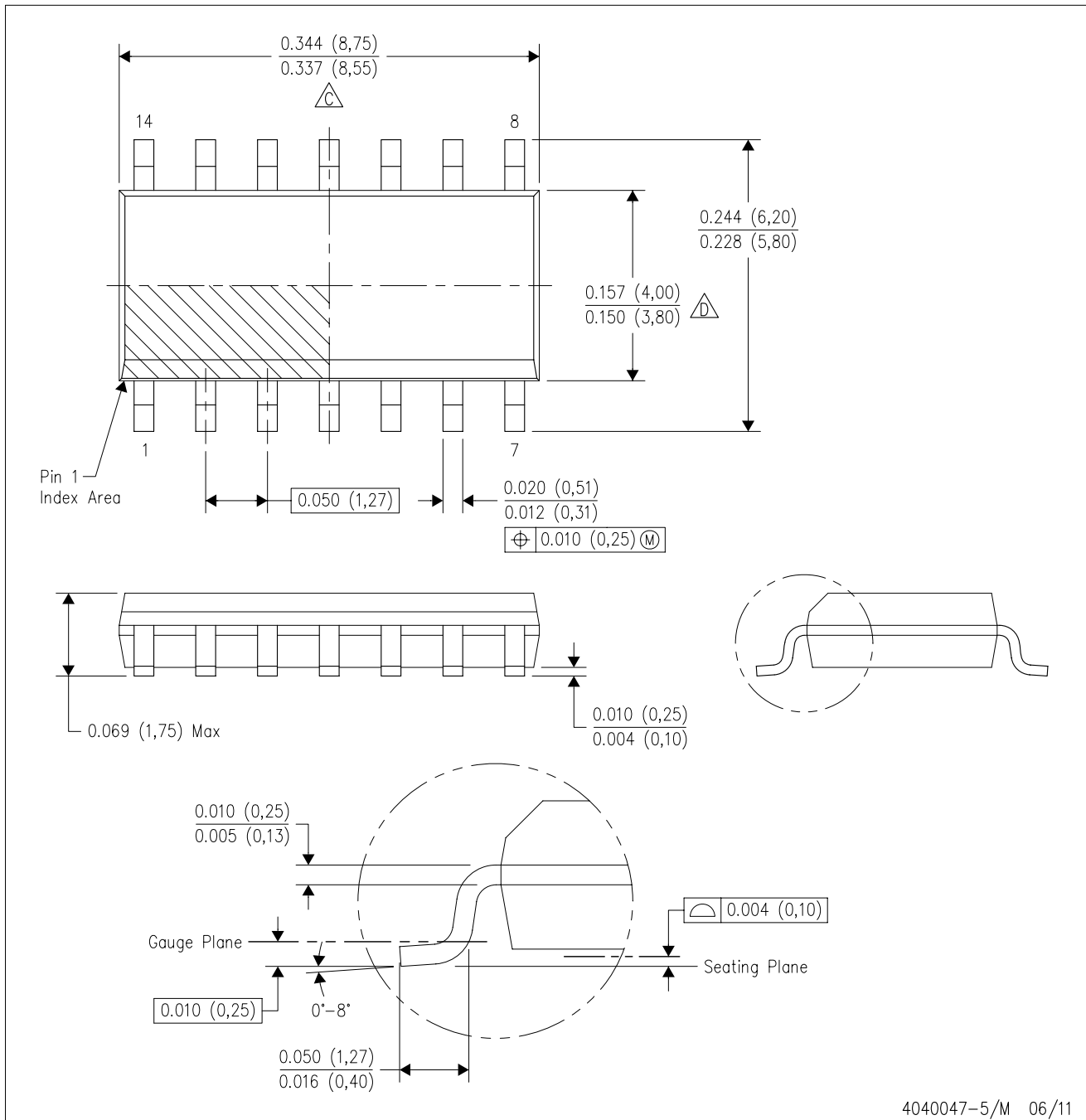
PLASTIC SMALL OUTLINE



4040047-5/M 06/11

- NOTES:
- A. All linear dimensions are in inches (millimeters).
 - B. This drawing is subject to change without notice.
 -  Body length does not include mold flash, protrusions, or gate burrs. Mold flash, protrusions, or gate burrs shall not exceed 0.006 (0,15) each side.
 -  Body width does not include interlead flash. Interlead flash shall not exceed 0.017 (0,43) each side.
 - E. Reference JEDEC MS-012 variation AB.

D (R-PDSO-G14)

PLASTIC SMALL OUTLINE



4211283-3/E 08/12

- NOTES:
- All linear dimensions are in millimeters.
 - This drawing is subject to change without notice.
 - Publication IPC-7351 is recommended for alternate designs.
 - Laser cutting apertures with trapezoidal walls and also rounding corners will offer better paste release. Customers should contact their board assembly site for stencil design recommendations. Refer to IPC-7525 for other stencil recommendations.
 - Customers should contact their board fabrication site for solder mask tolerances between and around signal pads.

PW (R-PDSO-G14)

PLASTIC SMALL OUTLINE



4040064-3/G 02/11

- NOTES:
- A. All linear dimensions are in millimeters. Dimensioning and tolerancing per ASME Y14.5M-1994.
 - B. This drawing is subject to change without notice.
 -  C. Body length does not include mold flash, protrusions, or gate burrs. Mold flash, protrusions, or gate burrs shall not exceed 0,15 each side.
 -  D. Body width does not include interlead flash. Interlead flash shall not exceed 0,25 each side.
 - E. Falls within JEDEC MO-153



D0008A

PACKAGE OUTLINE

SOIC - 1.75 mm max height

SMALL OUTLINE INTEGRATED CIRCUIT



4214825/C 02/2019

NOTES:

- Linear dimensions are in inches [millimeters]. Dimensions in parenthesis are for reference only. Controlling dimensions are in inches. Dimensioning and tolerancing per ASME Y14.5M.
- This drawing is subject to change without notice.
- This dimension does not include mold flash, protrusions, or gate burrs. Mold flash, protrusions, or gate burrs shall not exceed $.006$ [0.15] per side.
- This dimension does not include interlead flash.
- Reference JEDEC registration MS-012, variation AA.

EXAMPLE BOARD LAYOUT

D0008A

SOIC - 1.75 mm max height

SMALL OUTLINE INTEGRATED CIRCUIT



LAND PATTERN EXAMPLE
 EXPOSED METAL SHOWN
 SCALE:8X



SOLDER MASK DETAILS

4214825/C 02/2019

NOTES: (continued)

- 6. Publication IPC-7351 may have alternate designs.
- 7. Solder mask tolerances between and around signal pads can vary based on board fabrication site.

EXAMPLE STENCIL DESIGN

D0008A

SOIC - 1.75 mm max height

SMALL OUTLINE INTEGRATED CIRCUIT



SOLDER PASTE EXAMPLE
BASED ON .005 INCH [0.125 MM] THICK STENCIL
SCALE:8X

4214825/C 02/2019

NOTES: (continued)

8. Laser cutting apertures with trapezoidal walls and rounded corners may offer better paste release. IPC-7525 may have alternate design recommendations.
9. Board assembly site may have different recommendations for stencil design.

P (R-PDIP-T8)

PLASTIC DUAL-IN-LINE PACKAGE



- NOTES:
- A. All linear dimensions are in inches (millimeters).
 - B. This drawing is subject to change without notice.
 - C. Falls within JEDEC MS-001 variation BA.

N (R-PDIP-T**)

PLASTIC DUAL-IN-LINE PACKAGE

16 PINS SHOWN



- NOTES:
- A. All linear dimensions are in inches (millimeters).
 - B. This drawing is subject to change without notice.
 - Falls within JEDEC MS-001, except 18 and 20 pin minimum body length (Dim A).
 - The 20 pin end lead shoulder width is a vendor option, either half or full width.

DBV0006A



PACKAGE OUTLINE

SOT-23 - 1.45 mm max height

SMALL OUTLINE TRANSISTOR



4214840/C 06/2021

NOTES:

1. All linear dimensions are in millimeters. Any dimensions in parenthesis are for reference only. Dimensioning and tolerancing per ASME Y14.5M.
2. This drawing is subject to change without notice.
3. Body dimensions do not include mold flash or protrusion. Mold flash and protrusion shall not exceed 0.25 per side.
4. Leads 1,2,3 may be wider than leads 4,5,6 for package orientation.
5. Reference JEDEC MO-178.

EXAMPLE BOARD LAYOUT

DBV0006A

SOT-23 - 1.45 mm max height

SMALL OUTLINE TRANSISTOR



LAND PATTERN EXAMPLE
EXPOSED METAL SHOWN
SCALE:15X



SOLDER MASK DETAILS

4214840/C 06/2021

NOTES: (continued)

6. Publication IPC-7351 may have alternate designs.
7. Solder mask tolerances between and around signal pads can vary based on board fabrication site.

EXAMPLE STENCIL DESIGN

DBV0006A

SOT-23 - 1.45 mm max height

SMALL OUTLINE TRANSISTOR



SOLDER PASTE EXAMPLE
BASED ON 0.125 mm THICK STENCIL
SCALE:15X

4214840/C 06/2021

NOTES: (continued)

8. Laser cutting apertures with trapezoidal walls and rounded corners may offer better paste release. IPC-7525 may have alternate design recommendations.
9. Board assembly site may have different recommendations for stencil design.

PWP (R-PDSO-G14)

PowerPAD™ PLASTIC SMALL OUTLINE

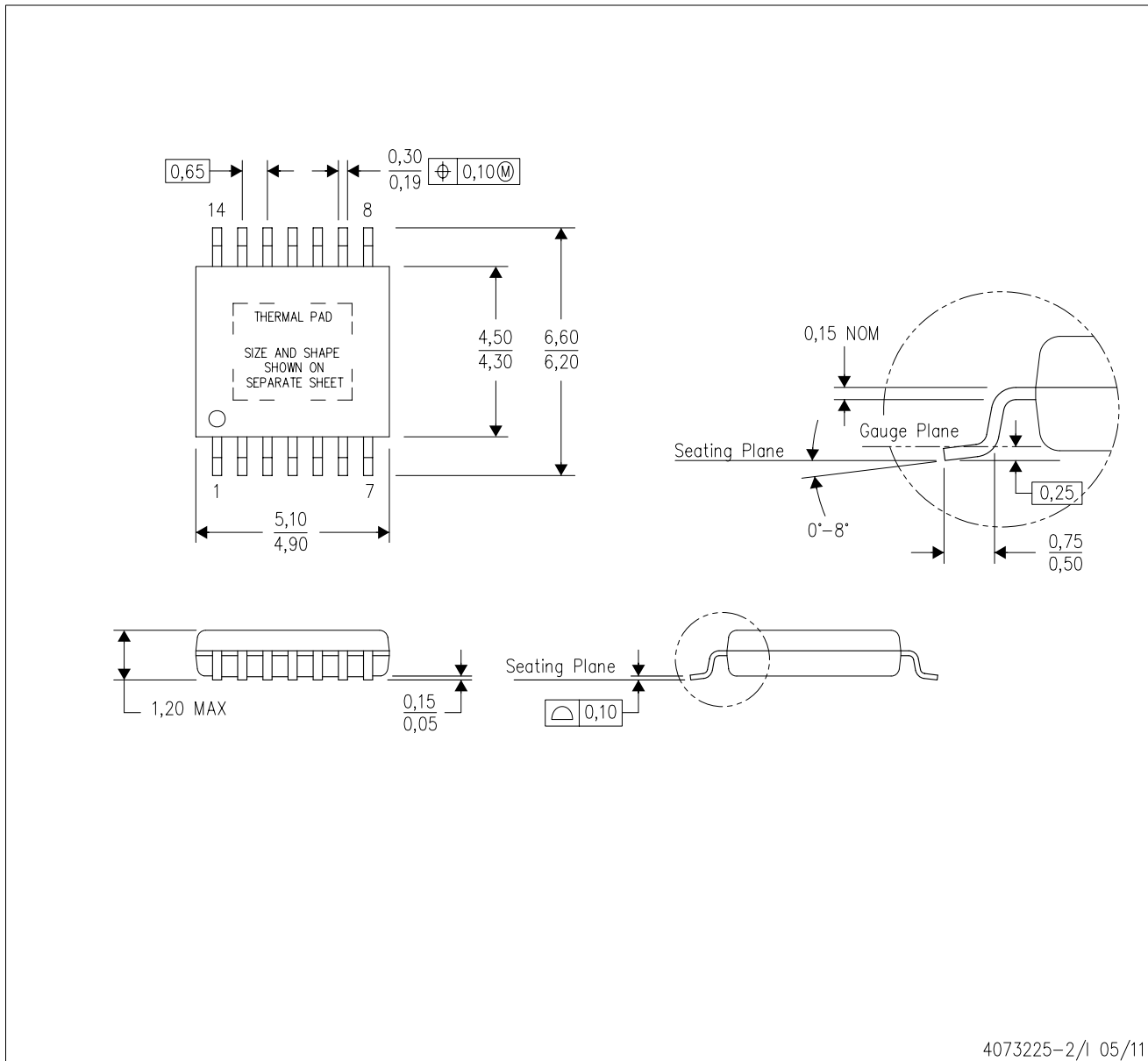

4073225-2/1 05/11

- NOTES:
- A. All linear dimensions are in millimeters.
 - B. This drawing is subject to change without notice.
 - C. Body dimensions do not include mold flash or protrusions. Mold flash and protrusion shall not exceed 0.15 per side.
 - D. This package is designed to be soldered to a thermal pad on the board. Refer to Technical Brief, PowerPad Thermally Enhanced Package, Texas Instruments Literature No. SLMA002 for information regarding recommended board layout. This document is available at www.ti.com <<http://www.ti.com>>.
 - E. See the additional figure in the Product Data Sheet for details regarding the exposed thermal pad features and dimensions.
 - E. Falls within JEDEC MO-153

PowerPAD is a trademark of Texas Instruments.

THERMAL PAD MECHANICAL DATA

PWP (R-PDSO-G14)

PowerPAD™ SMALL PLASTIC OUTLINE

THERMAL INFORMATION

This PowerPAD™ package incorporates an exposed thermal pad that is designed to be attached to a printed circuit board (PCB). The thermal pad must be soldered directly to the PCB. After soldering, the PCB can be used as a heatsink. In addition, through the use of thermal vias, the thermal pad can be attached directly to the appropriate copper plane shown in the electrical schematic for the device, or alternatively, can be attached to a special heatsink structure designed into the PCB. This design optimizes the heat transfer from the integrated circuit (IC).

For additional information on the PowerPAD package and how to take advantage of its heat dissipating abilities, refer to Technical Brief, PowerPAD Thermally Enhanced Package, Texas Instruments Literature No. SLMA002 and Application Brief, PowerPAD Made Easy, Texas Instruments Literature No. SLMA004. Both documents are available at www.ti.com.

The exposed thermal pad dimensions for this package are shown in the following illustration.

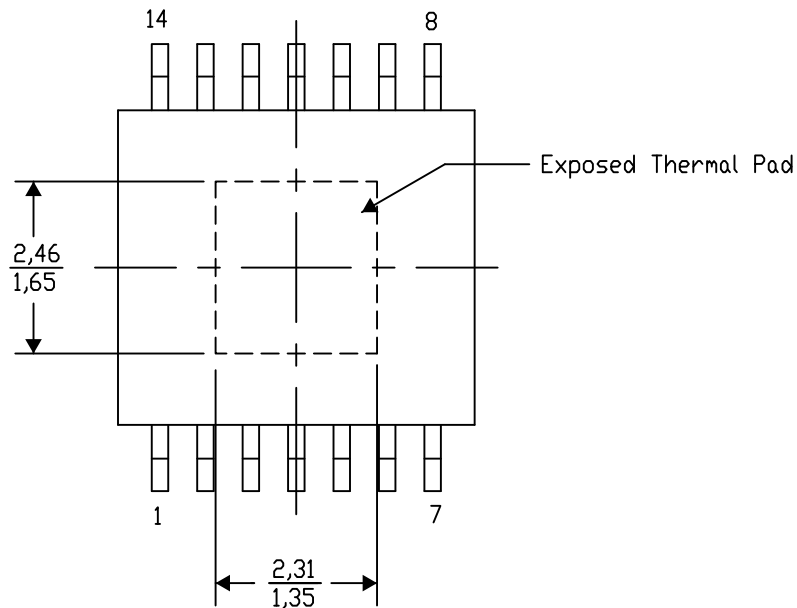

Top View

Exposed Thermal Pad Dimensions

4206332-2/AO 01/16

NOTE: A. All linear dimensions are in millimeters

PowerPAD is a trademark of Texas Instruments

PWP (R-PDSO-G14)

PowerPAD™ PLASTIC SMALL OUTLINE

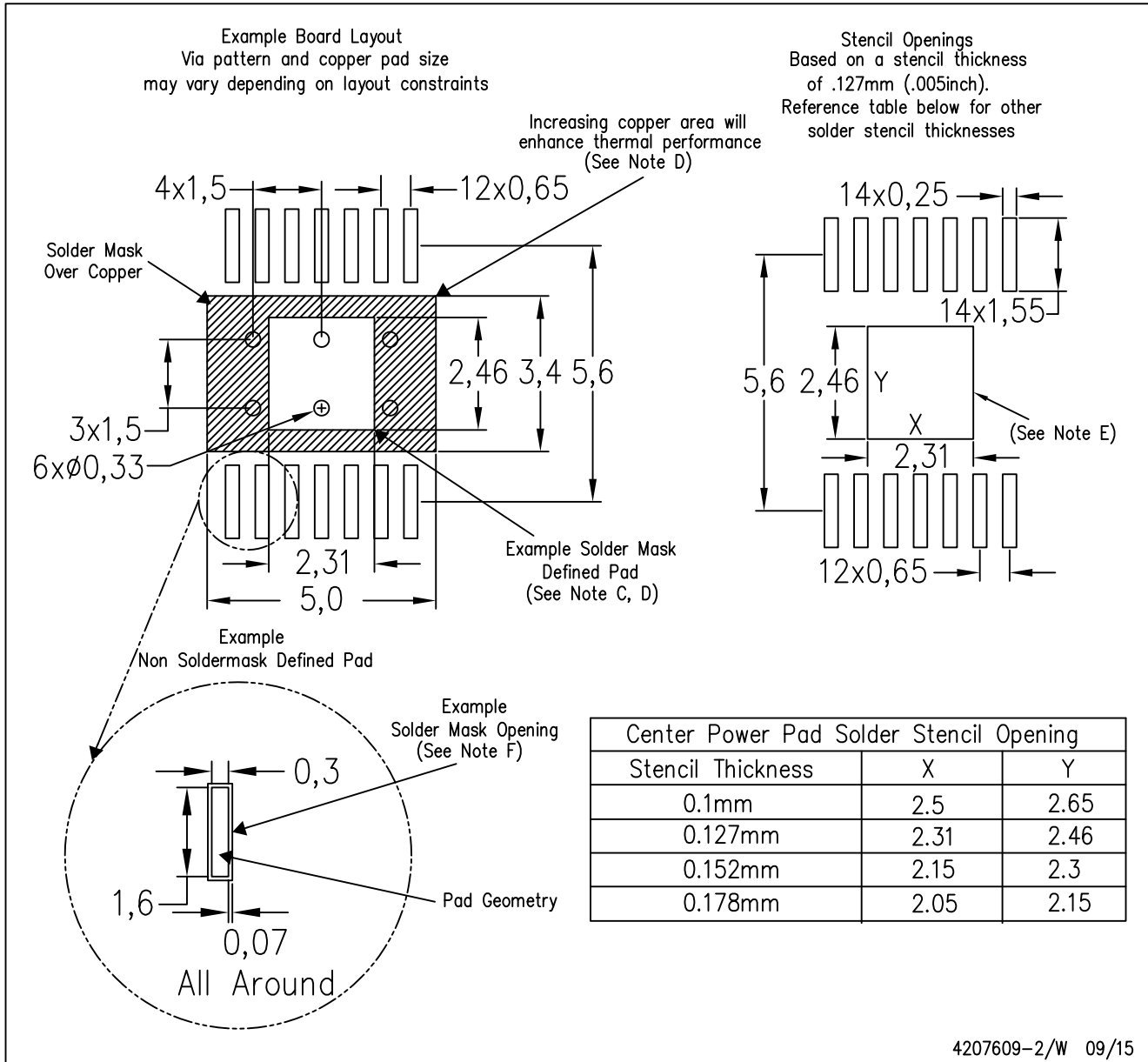

4207609-2/W 09/15

- NOTES:
- A. All linear dimensions are in millimeters.
 - B. This drawing is subject to change without notice.
 - C. Customers should place a note on the circuit board fabrication drawing not to alter the center solder mask defined pad.
 - D. This package is designed to be soldered to a thermal pad on the board. Refer to Technical Brief, PowerPAD Thermally Enhanced Package, Texas Instruments Literature No. SLMA002, SLMA004, and also the Product Data Sheets for specific thermal information, via requirements, and recommended board layout. These documents are available at www.ti.com <<http://www.ti.com>>. Publication IPC-7351 is recommended for alternate designs.
 - E. Laser cutting apertures with trapezoidal walls and also rounding corners will offer better paste release. Customers should contact their board assembly site for stencil design recommendations. Example stencil design based on a 50% volumetric metal load solder paste. Refer to IPC-7525 for other stencil recommendations.
 - F. Customers should contact their board fabrication site for solder mask tolerances between and around signal pads.

THERMAL PAD MECHANICAL DATA

PWP (R-PDSO-G14) PowerPAD™ SMALL PLASTIC OUTLINE

THERMAL INFORMATION

This PowerPAD™ package incorporates an exposed thermal pad that is designed to be attached to a printed circuit board (PCB). The thermal pad must be soldered directly to the PCB. After soldering, the PCB can be used as a heatsink. In addition, through the use of thermal vias, the thermal pad can be attached directly to the appropriate copper plane shown in the electrical schematic for the device, or alternatively, can be attached to a special heatsink structure designed into the PCB. This design optimizes the heat transfer from the integrated circuit (IC).

For additional information on the PowerPAD package and how to take advantage of its heat dissipating abilities, refer to Technical Brief, PowerPAD Thermally Enhanced Package, Texas Instruments Literature No. SLMA002 and Application Brief, PowerPAD Made Easy, Texas Instruments Literature No. SLMA004. Both documents are available at www.ti.com.

The exposed thermal pad dimensions for this package are shown in the following illustration.

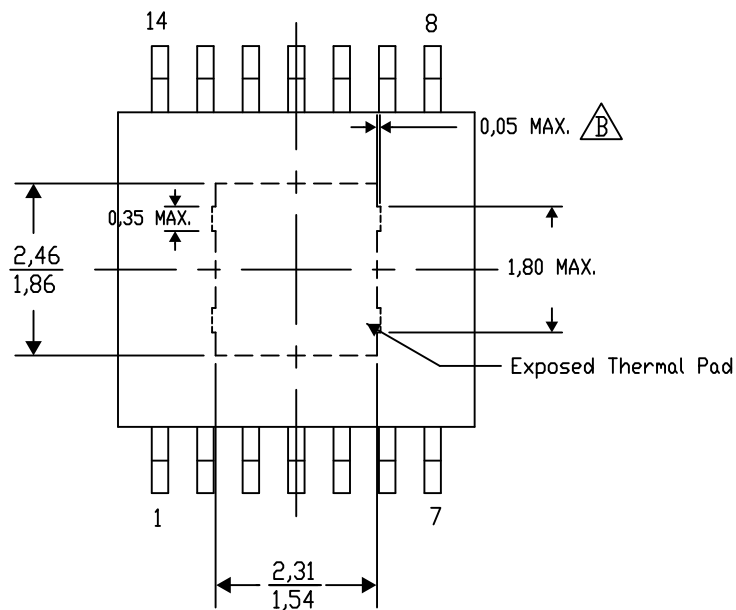

Top View

Exposed Thermal Pad Dimensions

4206332-44/AO 01/16

NOTE: A. All linear dimensions are in millimeters

$\triangle B$ Exposed tie strap features may not be present.

PowerPAD is a trademark of Texas Instruments

PWP (R-PDSO-G14)

PowerPAD™ PLASTIC SMALL OUTLINE

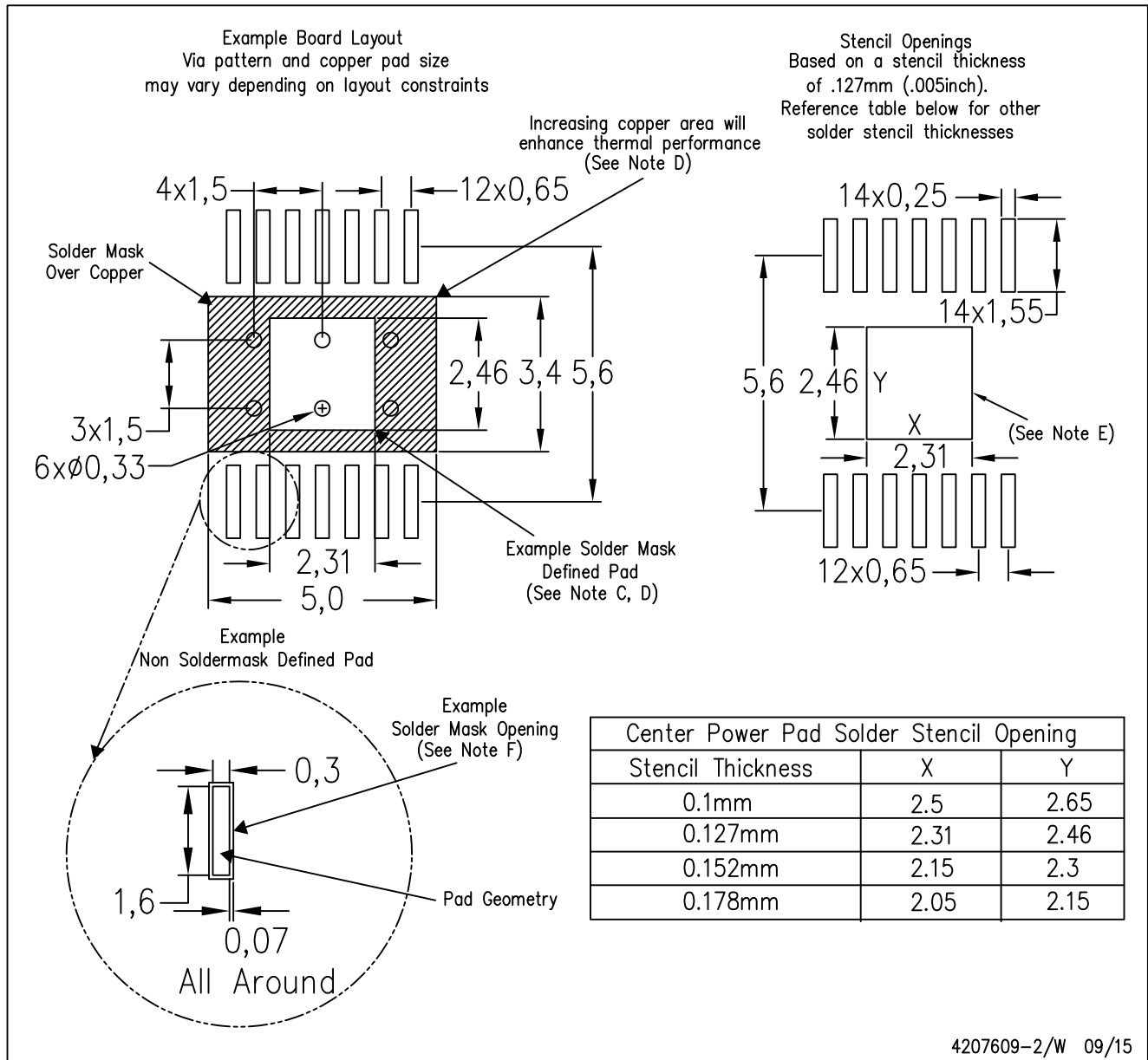

4207609-2/W 09/15

- NOTES:
- A. All linear dimensions are in millimeters.
 - B. This drawing is subject to change without notice.
 - C. Customers should place a note on the circuit board fabrication drawing not to alter the center solder mask defined pad.
 - D. This package is designed to be soldered to a thermal pad on the board. Refer to Technical Brief, PowerPAD Thermally Enhanced Package, Texas Instruments Literature No. SLMA002, SLMA004, and also the Product Data Sheets for specific thermal information, via requirements, and recommended board layout. These documents are available at www.ti.com <<http://www.ti.com>>. Publication IPC-7351 is recommended for alternate designs.
 - E. Laser cutting apertures with trapezoidal walls and also rounding corners will offer better paste release. Customers should contact their board assembly site for stencil design recommendations. Example stencil design based on a 50% volumetric metal load solder paste. Refer to IPC-7525 for other stencil recommendations.
 - F. Customers should contact their board fabrication site for solder mask tolerances between and around signal pads.

IMPORTANT NOTICE AND DISCLAIMER

TI PROVIDES TECHNICAL AND RELIABILITY DATA (INCLUDING DATA SHEETS), DESIGN RESOURCES (INCLUDING REFERENCE DESIGNS), APPLICATION OR OTHER DESIGN ADVICE, WEB TOOLS, SAFETY INFORMATION, AND OTHER RESOURCES "AS IS" AND WITH ALL FAULTS, AND DISCLAIMS ALL WARRANTIES, EXPRESS AND IMPLIED, INCLUDING WITHOUT LIMITATION ANY IMPLIED WARRANTIES OF MERCHANTABILITY, FITNESS FOR A PARTICULAR PURPOSE OR NON-INFRINGEMENT OF THIRD PARTY INTELLECTUAL PROPERTY RIGHTS.

These resources are intended for skilled developers designing with TI products. You are solely responsible for (1) selecting the appropriate TI products for your application, (2) designing, validating and testing your application, and (3) ensuring your application meets applicable standards, and any other safety, security, regulatory or other requirements.

These resources are subject to change without notice. TI grants you permission to use these resources only for development of an application that uses the TI products described in the resource. Other reproduction and display of these resources is prohibited. No license is granted to any other TI intellectual property right or to any third party intellectual property right. TI disclaims responsibility for, and you will fully indemnify TI and its representatives against, any claims, damages, costs, losses, and liabilities arising out of your use of these resources.

TI's products are provided subject to [TI's Terms of Sale](#) or other applicable terms available either on ti.com or provided in conjunction with such TI products. TI's provision of these resources does not expand or otherwise alter TI's applicable warranties or warranty disclaimers for TI products.

TI objects to and rejects any additional or different terms you may have proposed.

Mailing Address: Texas Instruments, Post Office Box 655303, Dallas, Texas 75265
Copyright © 2022, Texas Instruments Incorporated