





SMT Power Inductors

Unshielded Drum Core - PF0580NL Series



-  **Height:** 3.48mm Max
-  **Footprint:** 4.7mm Typ x 4.2mm Max
-  **Current Rating:** up to 3.1A
-  **Inductance Range:** 1 μ H to 65 μ H
-  260°C reflow peak temperature qualified

Electrical Specifications @ 25°C - Operating Temperature -40°C to +125°C⁶

Part ⁵ Number	Inductance ¹ @ I _{rated} (μ H TYP)	I _{rated} ² (A)	DCR (MAX) (m Ω MAX)	Inductance @ 0A _{DC} (μ H \pm 15%)	Saturation Current ³ I _{sat} (A)	Heating Current ⁴ I _{bc} (A)
PF0580.102NL	1.0	3.1	35	1.0	3.6	3.1
PF0580.152NL	1.4	2.7	40	1.5	2.7	2.7
PF0580.182NL *	1.7	2.4	45	1.8	2.4	2.6
PF0580.222NL	2.1	2.2	49	2.2	2.2	2.4
PF0580.272NL *	2.6	2.0	58	2.7	2.0	2.3
PF0580.332NL	3.1	1.8	63	3.3	1.8	2.25
PF0580.382NL	3.6	1.7	68	3.8	1.7	2.2
PF0580.472NL	4.5	1.6	77	4.7	1.6	2.0
PF0580.562NL	5.3	1.4	90	5.6	1.4	1.9
PF0580.682NL	6.5	1.3	100	6.8	1.3	1.8
PF0580.822NL	7.8	1.2	111	8.2	1.2	1.6
PF0580.103NL	9.5	1.1	132	10	1.1	1.5
PF0580.123NL	11	1.0	160	12	1.0	1.4
PF0580.153NL	14	0.85	197	15	0.85	1.3
PF0580.183NL *	17	0.80	255	18	0.80	1.1
PF0580.223NL	21	0.75	280	22	0.75	1.0
PF0580.273NL *	26	0.65	384	27	0.65	0.90
PF0580.333NL	31	0.58	427	33	0.58	0.85
PF0580.393NL	37	0.55	490	39	0.55	0.80
PF0580.473NL	45	0.50	645	47	0.50	0.70
PF0580.563NL	53	0.46	700	56	0.46	0.67
PF0580.683NL	65	0.41	827	68	0.41	0.62

Mechanical

Schematic

PF0580.XXXNL

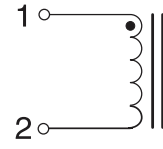
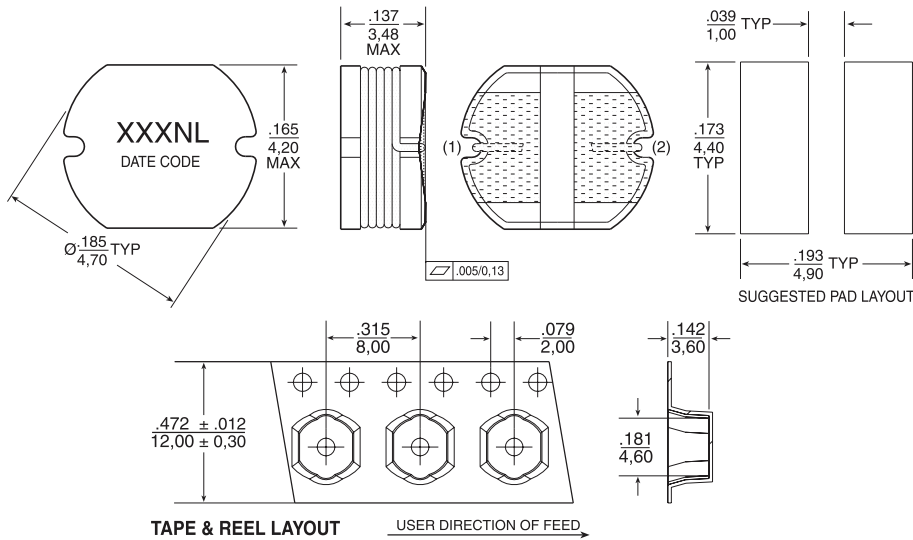

Weight6.0 grams
Tape & Reel160/reel
Dimensions: $\frac{\text{Inches}}{\text{mm}}$
Unless otherwise specified,
all tolerances are $\pm \frac{.004}{0,10}$

Notes from Tables:

- Inductance at I_{rated} is a typical inductance value measured when the inductor is subjected to the rated current.
- The rated current listed is the lower of the saturation current @ 25°C or the heating current.
- The saturation current, I_{sat} , is the current at which the component inductance drops by 20% (maximum) at an ambient temperature of 25°C. This current is determined by placing the component in the specified ambient environment and applying a short duration pulse current (to eliminate self-heating effects) to the component.
- The heating current, I_{hc} , is the DC current required to raise the component temperature by approximately 40°C. The heating current is determined by mounting the component on a typical PCB and applying current for 30 minutes.
- Optional Tape & Reel packaging can be ordered by adding a "T" suffix to the part number (i.e. PF0504.681NL becomes PF0504.681NLT). Pulse complies to industry standard tape and reel specification EIA481.
- The temperature of the component (ambient plus temperature rise) must be within the stated operating temperature range.

* Contact Pulse for availability

Typical Inductance vs Current Characteristics

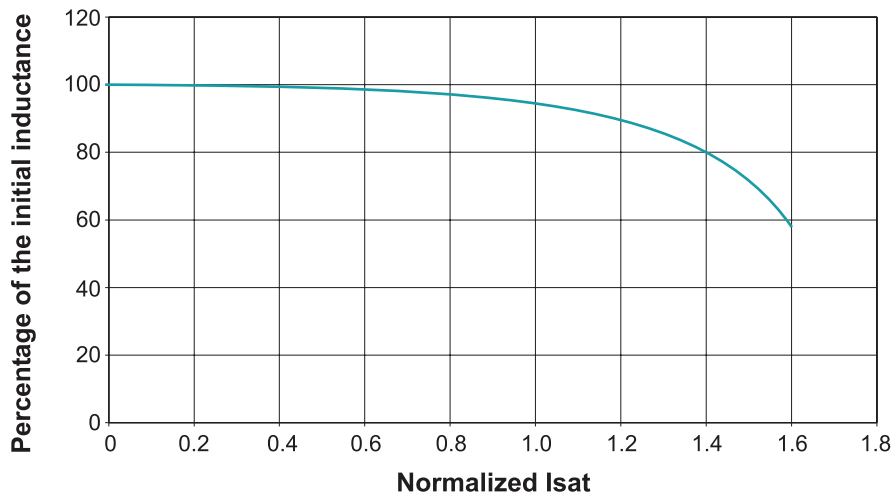

SMT Power Inductors

Unshielded Drum Core - PF0580NL Series



For More Information

Pulse Worldwide Headquarters

15255 Innovation Drive Ste 100
San Diego, CA 92128
U.S.A.

Tel: 858 674 8100
Fax: 858 674 8262

Pulse Europe

Pulse Electronics GmbH
Am Rottland 12
58540 Meinerzhagen
Germany

Tel: 49 2354 777 100
Fax: 49 2354 777 168

Pulse China Headquarters

Pulse Electronics (ShenZhen) CO., LTD
D708, Shenzhen Academy of
Aerospace Technology,
The 10th Keji South Road,
Nanshan District, Shenzhen,
P.R. China 518057

Tel: 86 755 33966678
Fax: 86 755 33966700

Pulse North China

Room 2704/2705
Super Ocean Finance Ctr.
2067 Yan An Road West
Shanghai 200336
China

Tel: 86 21 62787060
Fax: 86 2162786973

Pulse South Asia

3 Fraser Street 0428
DUO Tower
Singapore 189352

Tel: 65 6287 8998
Fax: 65 6280 0080

Pulse North Asia

1F., No.111 Xiyuan Road
Zhongli District
Taoyuan City 32057
Taiwan (R.O.C)

Tel: 886 3 4356768
Fax: 886 3 4356820

Performance warranty of products offered on this data sheet is limited to the parameters specified. Data is subject to change without notice. Other brand and product names mentioned herein may be trademarks or registered trademarks of their respective owners. © Copyright, 2019. Pulse Electronics, Inc. All rights reserved.