

SFH 3410

Smart DIL

Silicon NPN Phototransistor with V_{λ} Characteristics

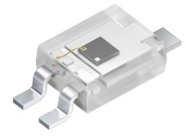

Applications

- Ambient Light Sensors
- Displays (Backlighting)
- Mood Lighting

Features:

- Package: clear epoxy
- Qualifications: AEC-Q102 Qualified
- ESD: 2 kV acc. to ANSI/ESDA/JEDEC JS-001 (HBM, Class 2)
- Especially suitable for applications from 350 nm to 970 nm
- Adapted to human eye sensitivity (V_{λ})
- SMT package without base connection, suitable for IR reflow soldering
- Only available on tape and reel
- Smart-DIL package
- Spectral range of sensitivity: (typ) 350 ... 970 nm

Ordering Information

Type	Photocurrent ¹⁾ $V_{CE} = 5 \text{ V}; \text{ Std. Light A}; E_v = 20 \text{ lx}$ I_{PCE}	Ordering Code
SFH 3410-Z	3.6 ... 22.4 μA	Q65110A1211
SFH 3410-1/2-Z	3.6 ... 9.0 μA	Q65110A2653
SFH 3410-2/3-Z	5.6 ... 14.0 μA	Q65110A2654
SFH 3410-3/4-Z	9.0 ... 22.4 μA	Q65110A2655

Maximum Ratings

 $T_A = 25\text{ °C}$

Parameter	Symbol		Values
Operating temperature	T_{op}	min.	-40 °C
		max.	100 °C
Storage temperature	T_{stg}	min.	-40 °C
		max.	100 °C
Collector-emitter voltage	V_{CE}	max.	5.5 V
Collector current	I_C	max.	20 mA
Emitter-collector voltage	V_{EC}	max.	0.5 V
ESD withstand voltage acc. to ANSI/ESDA/JEDEC JS-001 (HBM, Class 2)	V_{ESD}	max.	2 kV

Characteristics

$T_A = 25\text{ °C}$

Parameter	Symbol		Values
Wavelength of max sensitivity	$\lambda_{S\text{ max}}$	typ.	570 nm
Spectral range of sensitivity	$\lambda_{10\%}$	typ.	350 ... 970 nm
Dimensions of chip area	L x W	typ.	0.75 x 0.75 mm x mm
Radiant sensitive area	A	typ.	0.29 mm ²
Half angle	φ	typ.	60 °
Dark current	I_{CE0}	typ.	3 nA
$V_{CE} = 5\text{ V}$		max.	50 nA
Collector-emitter saturation voltage ²⁾ $I_C = I_{PCE,min} \times 0.3$; $E_e = 0\text{ mW/cm}^2$; $E_v = 20\text{ lx}$; 0	V_{CEsat}	typ.	100 mV
Capacitance $V_{CE} = 0\text{ V}$; $f = 1\text{ MHz}$; $E = 0$	C_{CE}	typ.	3.9 pF

Photocurrent Groups

$T_A = 25\text{ }^\circ\text{C}$

Group	Photocurrent ¹⁾	Photocurrent ¹⁾
	$V_{CE} = 5\text{ V}; \text{ Std. Light A}; E_v = 20\text{ lx}$ min. I_{PCE}	$V_{CE} = 5\text{ V}; \text{ Std. Light A}; E_v = 20\text{ lx}$ max. I_{PCE}
1	3.6 μA	5.6 μA
2	5.6 μA	9.0 μA
3	9.0 μA	14.0 μA
4	14.0 μA	22.4 μA

Relative Spectral Sensitivity ^{3), 4)}

$S_{rel} = f(\lambda)$

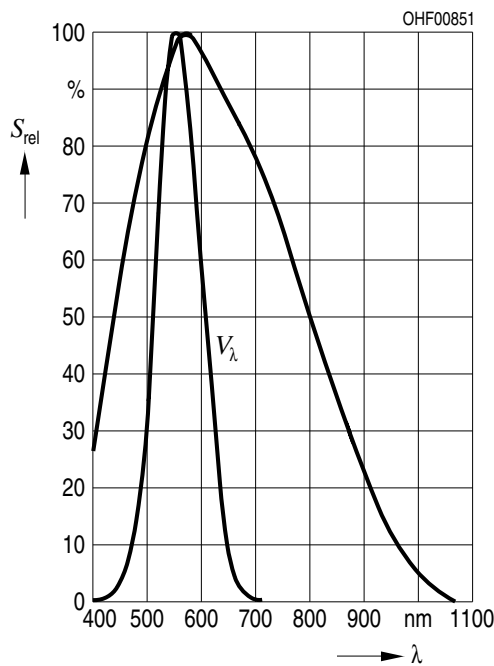

Directional Characteristics 3), 4)

$S_{rel} = f(\varphi)$

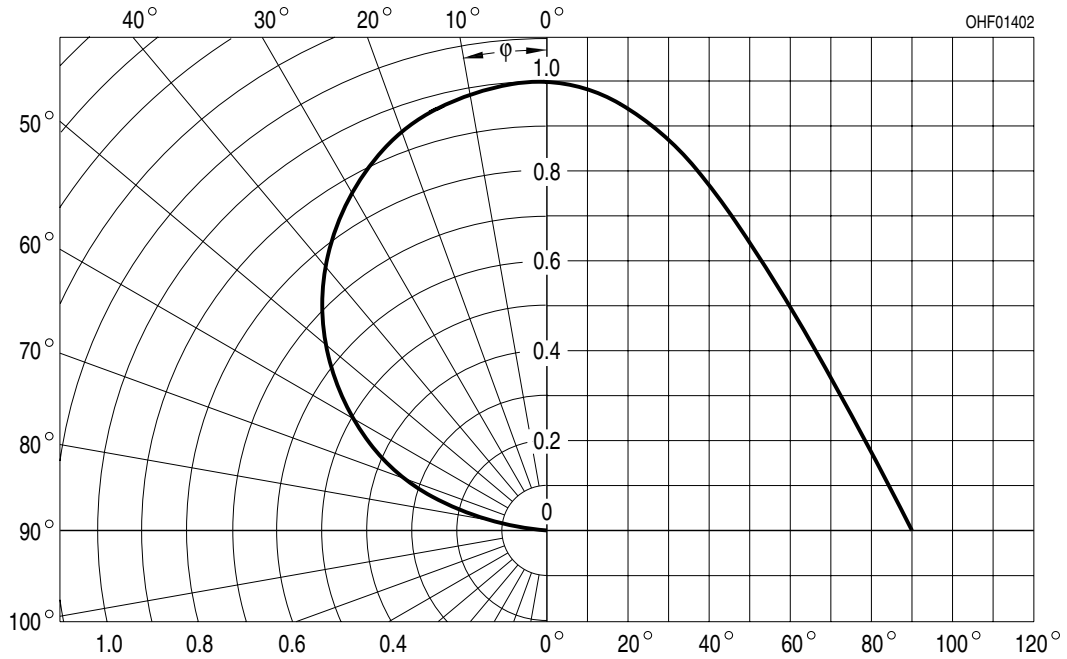

Photocurrent 3), 4)

$I_{PCE} = f(E_v); V_{CE} = 5 V; 0$

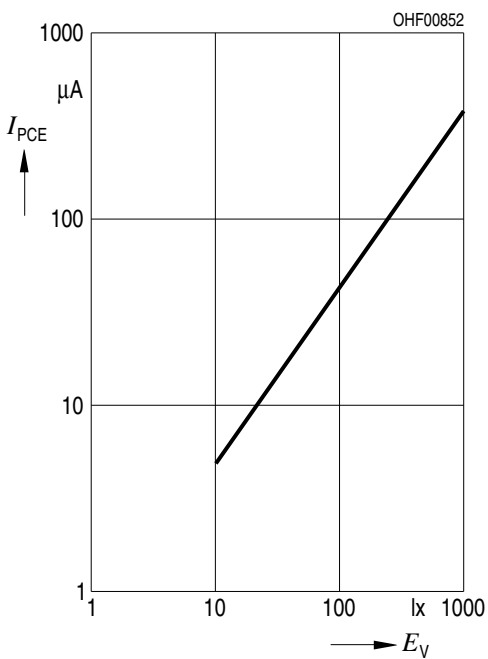

Collector-Emitter Current 3), 4)

$I_{CE} = f(V_{CE}, E_v); 0$

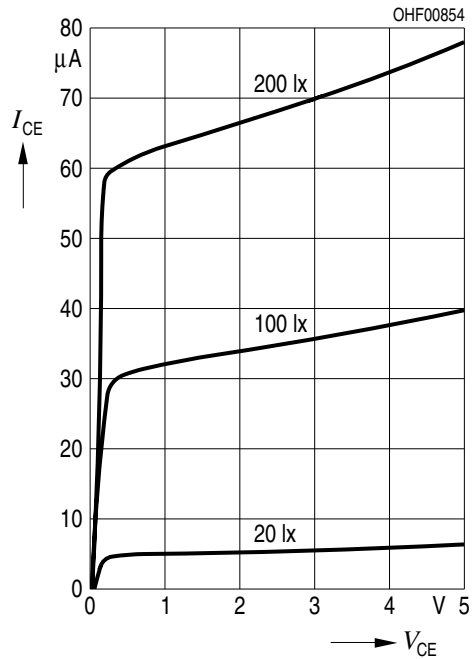

Collector-Emitter Capacitance ^{3), 4)}

$$C_{CE} = f(V_{CE}); f = 1 \text{ MHz}; E = 0$$

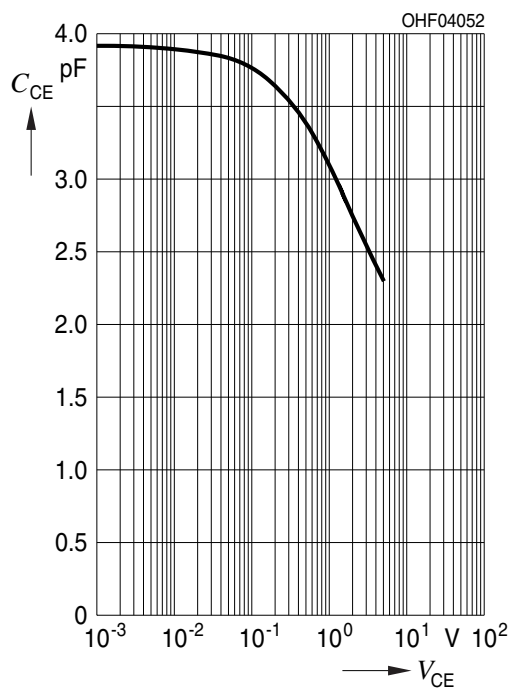

Photocurrent ³⁾

$$I_{PCE,rel} = f(T_A); V_{CE} = 5 \text{ V}; E_v = 20 \text{ lx}$$

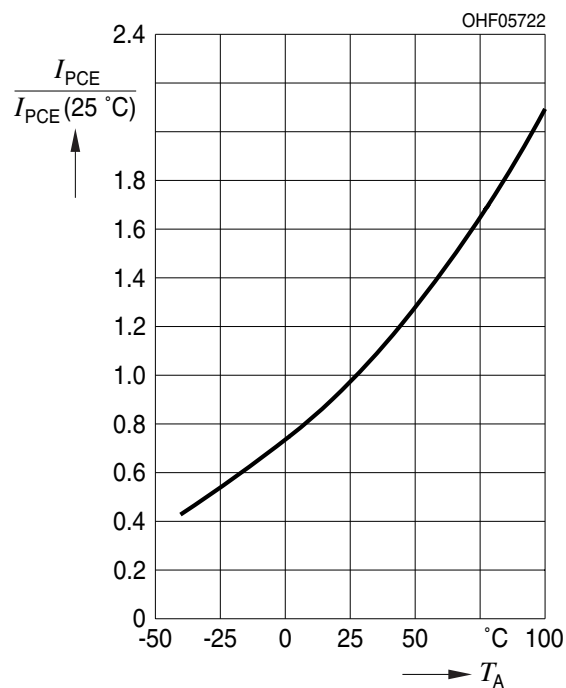

Dimensional Drawing ⁵⁾

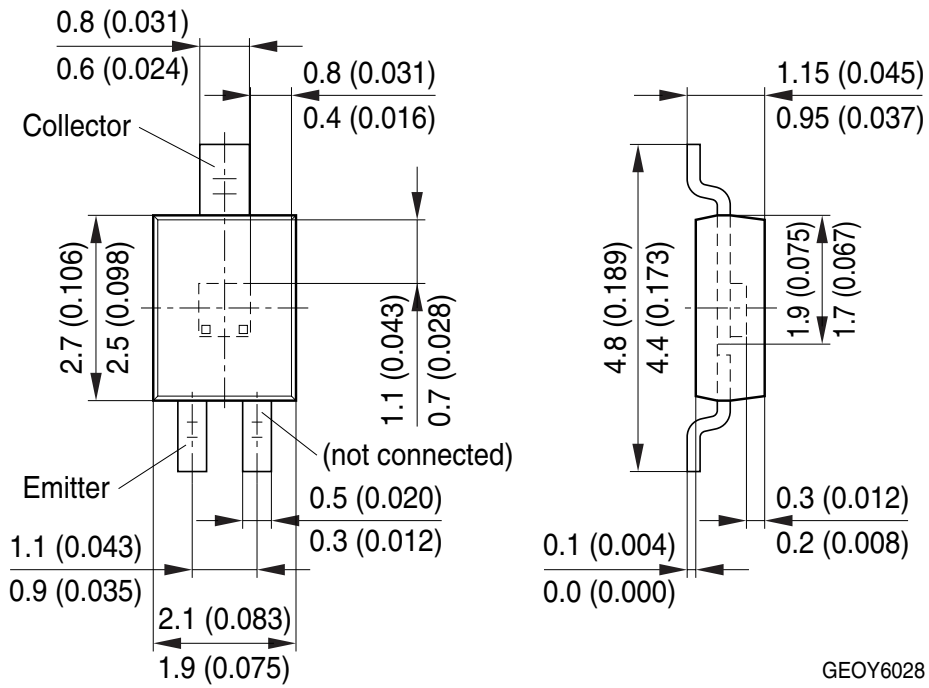

GEOY6028

Further Information:

Approximate Weight: 12.0 mg

Package marking: Collector

Recommended Solder Pad ⁵⁾

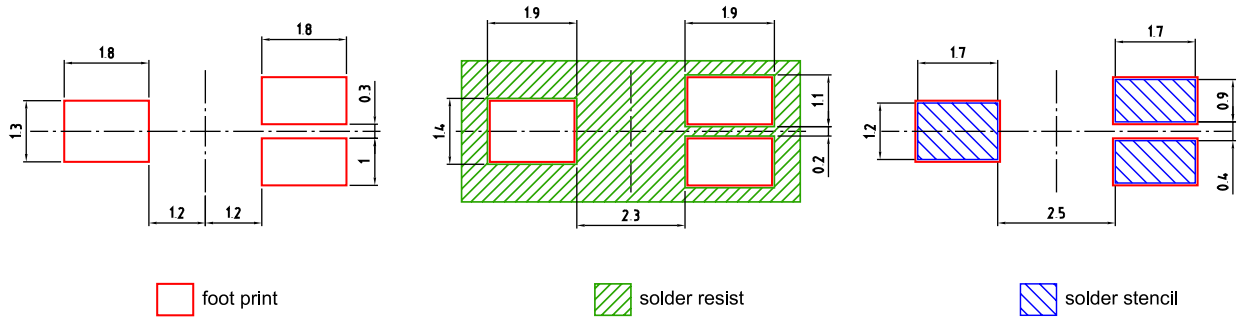

Component Location on Pad

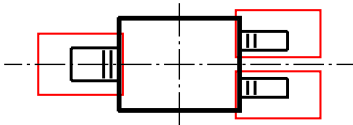

E062 3010 216-01

Reflow Soldering Profile

Product complies to MSL Level 4 acc. to JEDEC J-STD-020E

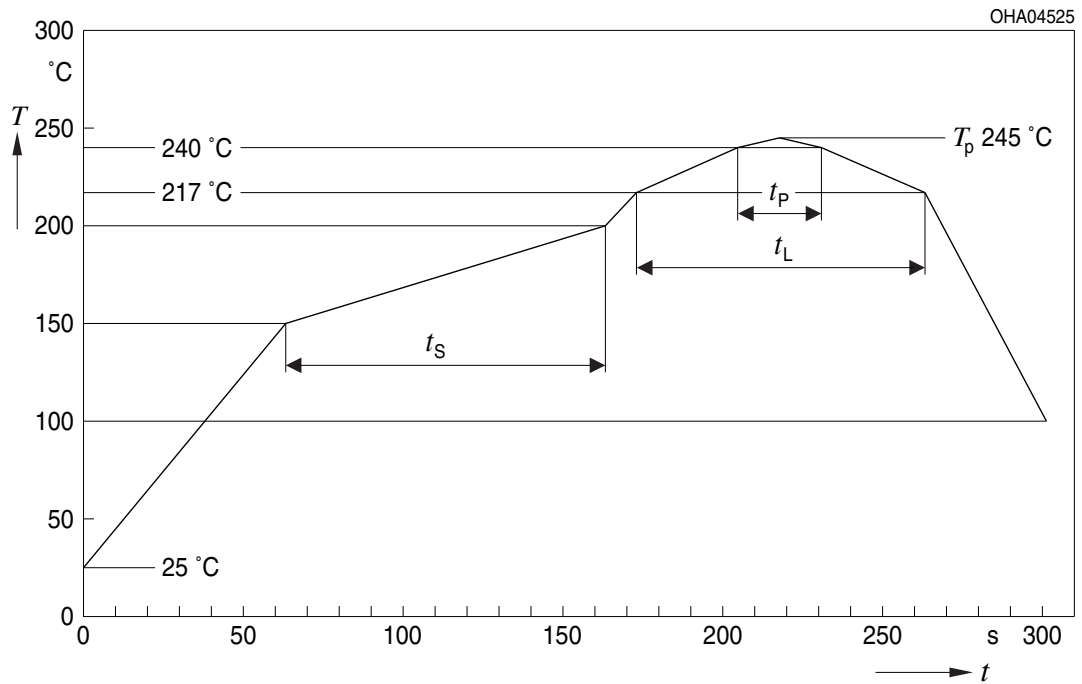

Profile Feature	Symbol	Pb-Free (SnAgCu) Assembly			Unit
		Minimum	Recommendation	Maximum	
Ramp-up rate to preheat*) 25 °C to 150 °C			2	3	K/s
Time t_s T_{Smin} to T_{Smax}	t_s	60	100	120	s
Ramp-up rate to peak*) T_{Smax} to T_p			2	3	K/s
Liquidus temperature	T_L		217		°C
Time above liquidus temperature	t_L		80	100	s
Peak temperature	T_p		245	260	°C
Time within 5 °C of the specified peak temperature $T_p - 5$ K	t_p	10	20	30	s
Ramp-down rate* T_p to 100 °C			3	6	K/s
Time 25 °C to T_p				480	s

All temperatures refer to the center of the package, measured on the top of the component
 * slope calculation DT/Dt : Dt max. 5 s; fulfillment for the whole T-range

Taping ⁵⁾

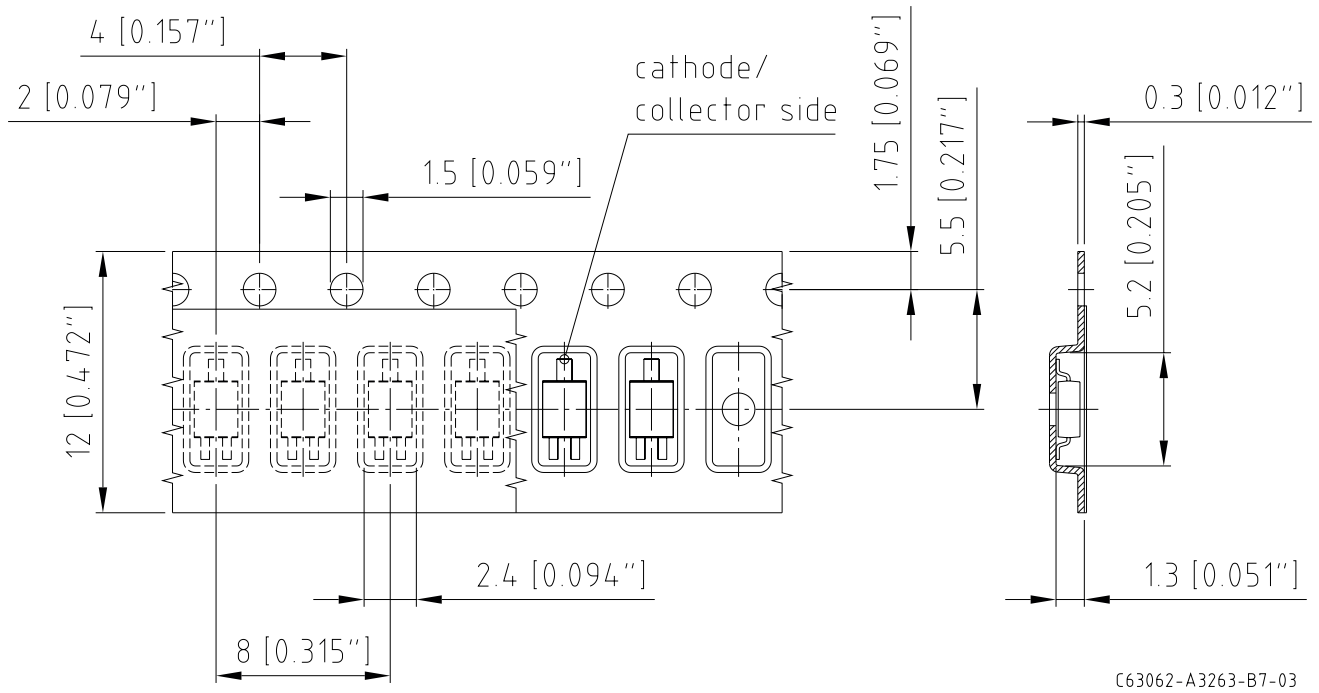

C63062-A3263-B7-03

Tape and Reel ⁶⁾

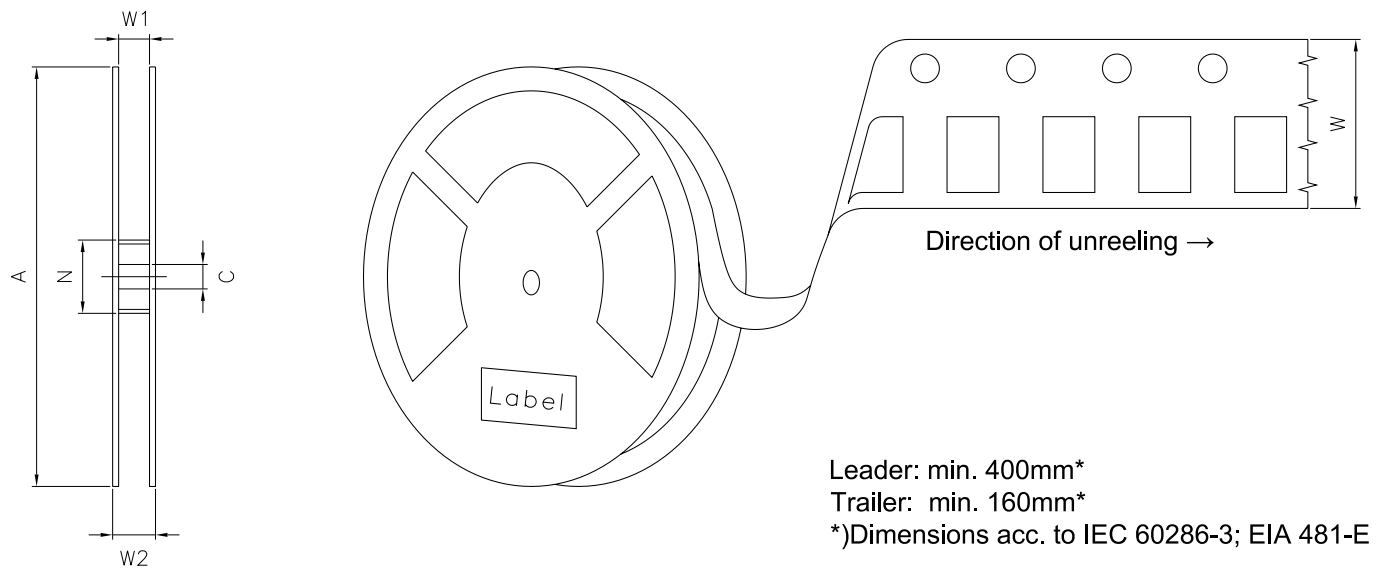

Reel Dimensions

A	W	N _{min}	W ₁	W _{2max}	Pieces per PU
180 mm	12 + 0.3 / - 0.1 mm	60 mm	12.4 + 2 mm	18.4 mm	2000

Barcode-Product-Label (BPL)

OSRAM Opto Semiconductors LX XXXX BIN1: XX-XX-X-XXX-X

RoHS Compliant

(6P) BATCH NO: 1234567890

(1T) LOT NO: 1234567890 (9D) D/C: 1234

(X) PROD NO: 123456789(Q)QTY: 9999 (G) GROUP: XX-XX-X-X

ML Temp ST
X XXX °C X

Pack: RXX
DEMY XXX
X_X123_1234.1234 X

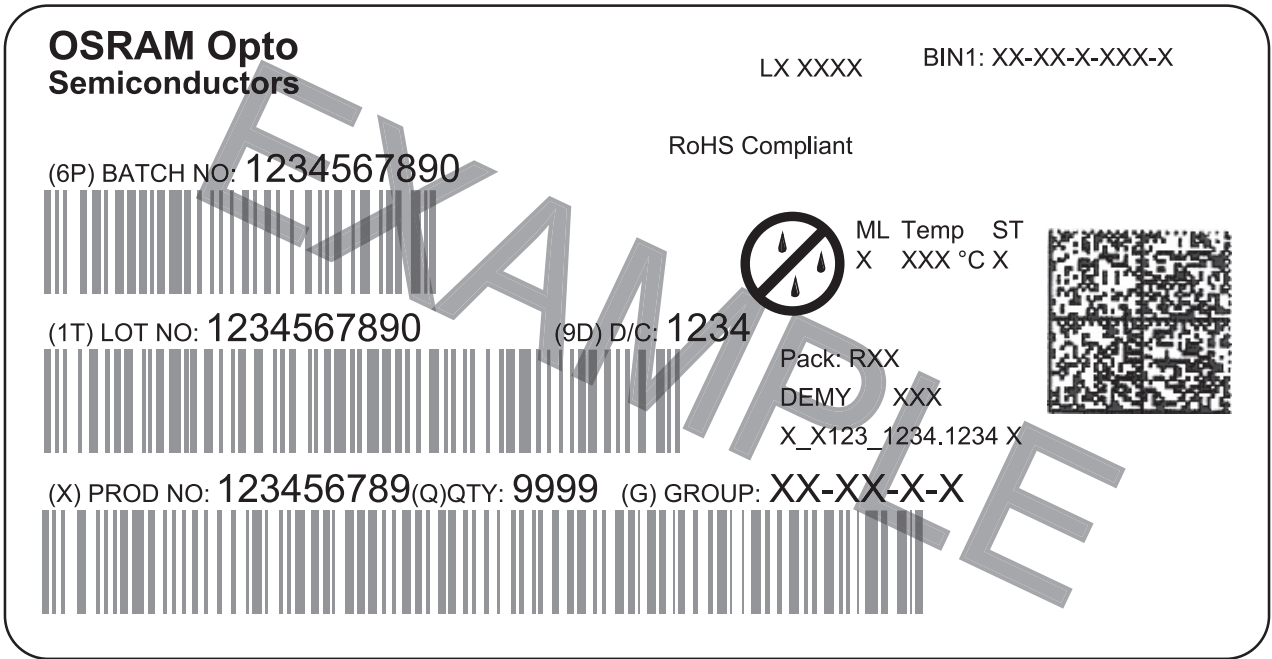

The diagram shows a rectangular label with rounded corners. It contains the OSRAM logo and product name at the top left. To the right are fields for 'LX XXXX' and 'BIN1: XX-XX-X-XXX-X'. Below the logo is the text 'RoHS Compliant'. The label features three horizontal barcode sections. The first is labeled '(6P) BATCH NO: 1234567890'. The second is labeled '(1T) LOT NO: 1234567890' and '(9D) D/C: 1234'. The third is labeled '(X) PROD NO: 123456789(Q)QTY: 9999' and '(G) GROUP: XX-XX-X-X'. To the right of the second barcode is a circular icon with a crossed-out rain cloud and the text 'ML Temp ST X XXX °C X'. Below this is a square QR code. Further down is the text 'Pack: RXX', 'DEMY XXX', and 'X_X123_1234.1234 X'. A large 'EXAMPLE' watermark is overlaid diagonally across the center of the label.

OHA04563

Dry Packing Process and Materials ⁵⁾

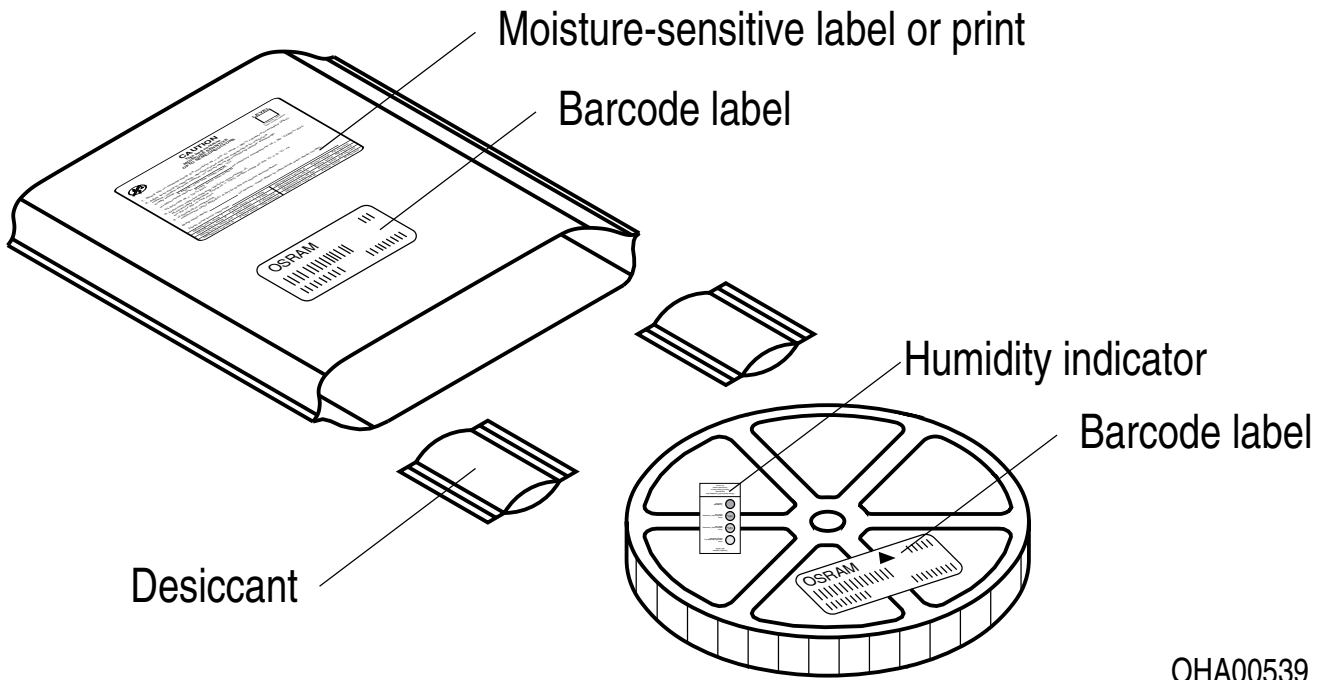

OHA00539

Moisture-sensitive product is packed in a dry bag containing desiccant and a humidity card according JEDEC-STD-033.

Notes

The evaluation of eye safety occurs according to the standard IEC 62471:2006 (photo biological safety of lamps and lamp systems). Within the risk grouping system of this IEC standard, the device specified in this data sheet fall into the class **exempt group (exposure time 10000 s)**. Under real circumstances (for exposure time, conditions of the eye pupils, observation distance), it is assumed that no endangerment to the eye exists from these devices. As a matter of principle, however, it should be mentioned that intense light sources have a high secondary exposure potential due to their blinding effect. When looking at bright light sources (e.g. headlights), temporary reduction in visual acuity and afterimages can occur, leading to irritation, annoyance, visual impairment, and even accidents, depending on the situation.

Subcomponents of this device contain, in addition to other substances, metal filled materials including silver. Metal filled materials can be affected by environments that contain traces of aggressive substances. Therefore, we recommend that customers minimize device exposure to aggressive substances during storage, production, and use. Devices that showed visible discoloration when tested using the described tests above did show no performance deviations within failure limits during the stated test duration. Respective failure limits are described in the IEC60810.

For further application related information please visit www.osram-os.com/appnotes

Disclaimer

Attention please!

The information describes the type of component and shall not be considered as assured characteristics. Terms of delivery and rights to change design reserved. Due to technical requirements components may contain dangerous substances.

For information on the types in question please contact our Sales Organization.

If printed or downloaded, please find the latest version on the OSRAM OS website.

Packing

Please use the recycling operators known to you. We can also help you – get in touch with your nearest sales office. By agreement we will take packing material back, if it is sorted. You must bear the costs of transport. For packing material that is returned to us unsorted or which we are not obliged to accept, we shall have to invoice you for any costs incurred.

Product and functional safety devices/applications or medical devices/applications

OSRAM OS components are not developed, constructed or tested for the application as safety relevant component or for the application in medical devices.

OSRAM OS products are not qualified at module and system level for such application.

In case buyer – or customer supplied by buyer – considers using OSRAM OS components in product safety devices/applications or medical devices/applications, buyer and/or customer has to inform the local sales partner of OSRAM OS immediately and OSRAM OS and buyer and /or customer will analyze and coordinate the customer-specific request between OSRAM OS and buyer and/or customer.

Glossary

- 1) **Photocurrent:** The photocurrent values are measured (by irradiating the devices with a homogenous light source and applying a voltage to the device) with a tolerance of $\pm 11\%$.
- 2) **IPCEmin:** IPCEmin is the min. photocurrent of the specified group.
- 3) **Typical Values:** Due to the special conditions of the manufacturing processes of semiconductor devices, the typical data or calculated correlations of technical parameters can only reflect statistical figures. These do not necessarily correspond to the actual parameters of each single product, which could differ from the typical data and calculated correlations or the typical characteristic line. If requested, e.g. because of technical improvements, these typ. data will be changed without any further notice.
- 4) **Testing temperature:** $T_A = 25^\circ\text{C}$ (unless otherwise specified)
- 5) **Tolerance of Measure:** Unless otherwise noted in drawing, tolerances are specified with ± 0.1 and dimensions are specified in mm.
- 6) **Tape and Reel:** All dimensions and tolerances are specified acc. IEC 60286-3 and specified in mm.

Revision History

Version	Date	Change
1.4	2021-06-29	Schematic Transportation Box Dimensions of Transportation Box

Published by OSRAM Opto Semiconductors GmbH EU RoHS and China RoHS compliant product
Leibnizstraße 4, D-93055 Regensburg
www.osram-os.com © All Rights Reserved.



此产品符合欧盟 RoHS 指令的要求；
按照中国的相关法规和标准，不含有毒有害物质或元素。