

## SPECIFICATION

Part No.	:	<b>DXP.01.A</b>
Product Name	:	SMD L1/L2 SAW Diplexer For GPS/GALILEO L1, GLONASS L2 & BeiDou B2
Features	:	L2 1227.6 / L1 1575.42MHz SAW Diplexer SMD Direct Mount Compact Size 5*5*1.7mm Low Insertion Loss In band High Isolation Port to Port RoHS and REACH Compliant



## **1. Introduction**

The Taoglas DXP.01.A is an advanced compact SAW diplexer for use in any navigation system application using the GPS/GALILEO L1, GLONASS L2 and BeiDou B2 bands.

The diplexer is designed to function as both a bandpass filter for each band and to either split one path into two or to combine both bands back into one RF feed. For example, a customer who wanted to use passive dual band antenna elements would need to implement a diplexer in some cases to split both bands out into separate paths. It is also designed to isolate and reject any unwanted GPS/GALILEO signals from getting to the application port.

It is housed in a compact 5\*5\*1.7mm over-molded laminate package and is easy to integrate using SMD process mounting directly onto the target PCB.

Contact your regional Taoglas sales office for more information or support.

## 2. Specification

L1 Band GPS/GALILEO			
	Min.	Typ.	Max.
<b>Center Frequency</b> (MHz)	-	1575.42	-
<b>Insertion Loss</b> (dB)	-	3.3	3.8
<b>Amplitude Ripple</b> (dB)	-	0.1	1.0
<b>Return Loss</b> (dB)	-	-12	-8.5
<b>Attenuation</b> (Reference level from 0dB)			
824 ~ 960 (MHz)	25	47	-
1500 ~ 1525.42 (MHz)	8	19	-
1625.42 ~ 1650 (MHz)	8	16	-
1710 ~ 2170 (MHz)	25	34	-
L2 Band GLONASS and B2 Band BeiDou			
	Min.	Typ.	Max.
<b>Center frequency</b> (MHz)	-	1227.625	-
<b>Insertion Loss</b> (dB)	-	4.1	4.8
<b>Amplitude Ripple</b> (dB)	-	0.9	1.8
<b>Return Loss</b> (dB)	-	-12	8.5
<b>Attenuation</b> (Reference level from 0dB)			
464 ~ 600 (MHz)	25	32	-
1110 ~ 1130 (MHz)	16	23	-
1330 ~ 1450 (MHz)	28	37	-
1500 ~ 1820 (MHz)	25	30	-
L1 Band GPS/GALILEO, L2 Band GLONASS and B2 Band BeiDou			
	Min.	Typ.	Max.
Isolation (1196.9~1248.625MHz)	22	36	-
Isolation (1574.22~1576.62 dB)	22	33	-
Environmental			
Operating Temperature	-40°C to 85°C		
Storage Temperature	-40°C to 85°C		
Input power Level	10 dBm		
DC Voltage	3 V		
Moisture Sensitivity Level (MSL)	3(168hrs)		

### 3. Measurement circuit

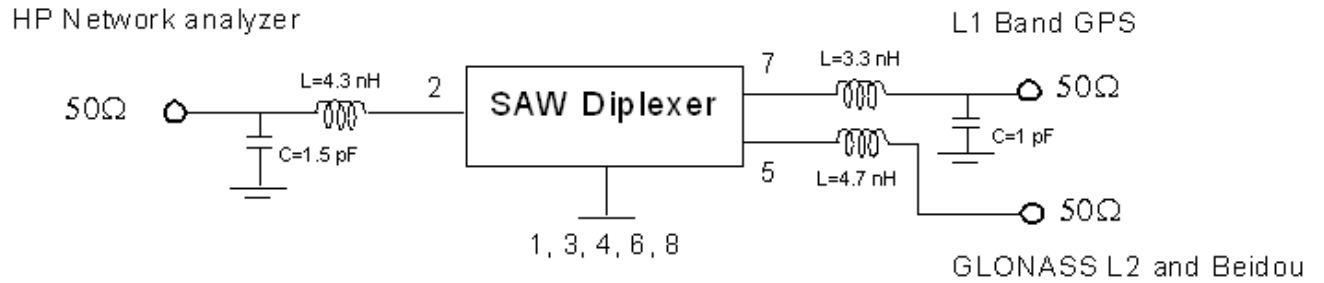

#### 3.1 Test setup

**Band 1 (L1)**      **Band 2(L2/L5)**



**Common Port**

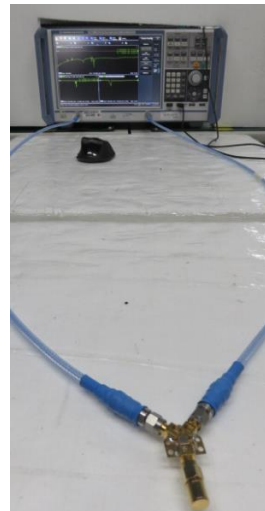

### 3.2 S-Parameter

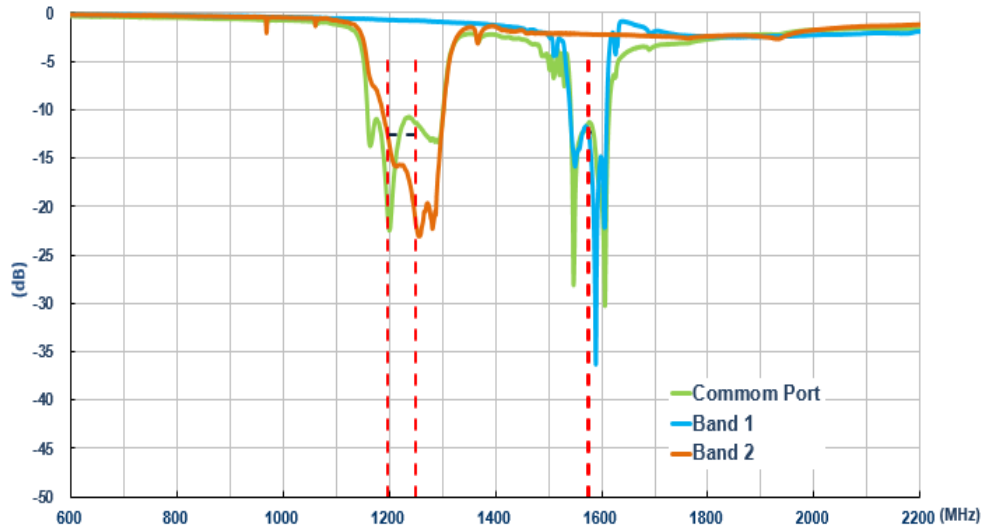

Return Loss (dB)	
<b>Band 1</b> 1574.22~1576.62MHz	<b>Band 2</b> 1196.9~1248.625MHz
<-12.3	<12.6

### 3.3. Common Port to Band 1 Port \_ 1575.42MHz Attenuation

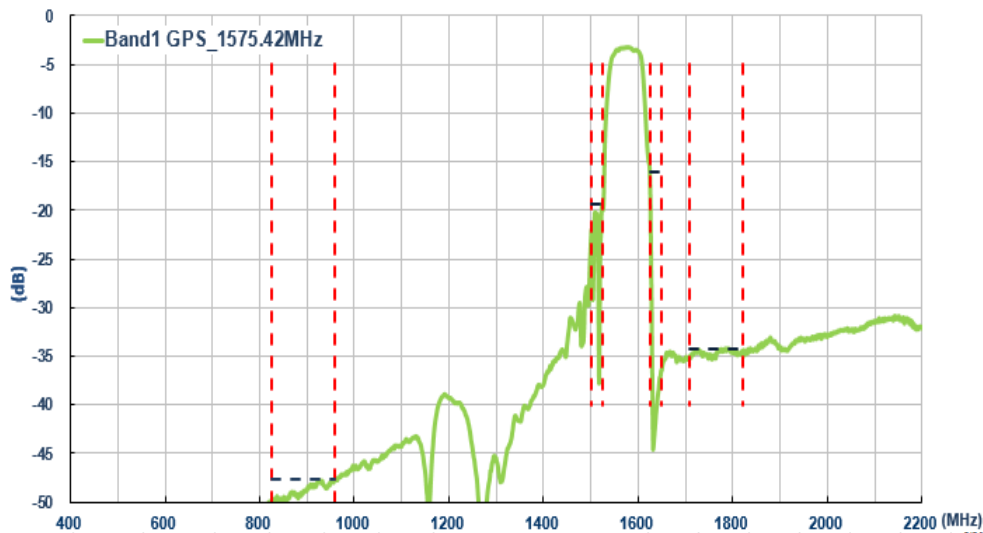

Attenuation (dB)			
<b>824~960MHz</b>	<b>1500~1525.42MHz</b>	<b>1625.42~1650MHz</b>	<b>1710~1820MHz</b>
<-47.6	<-19.4	<-16.1	<-34.2

### 3.4. Common Port to Band 1 Port \_ 1575.42MHz Insertion Loss

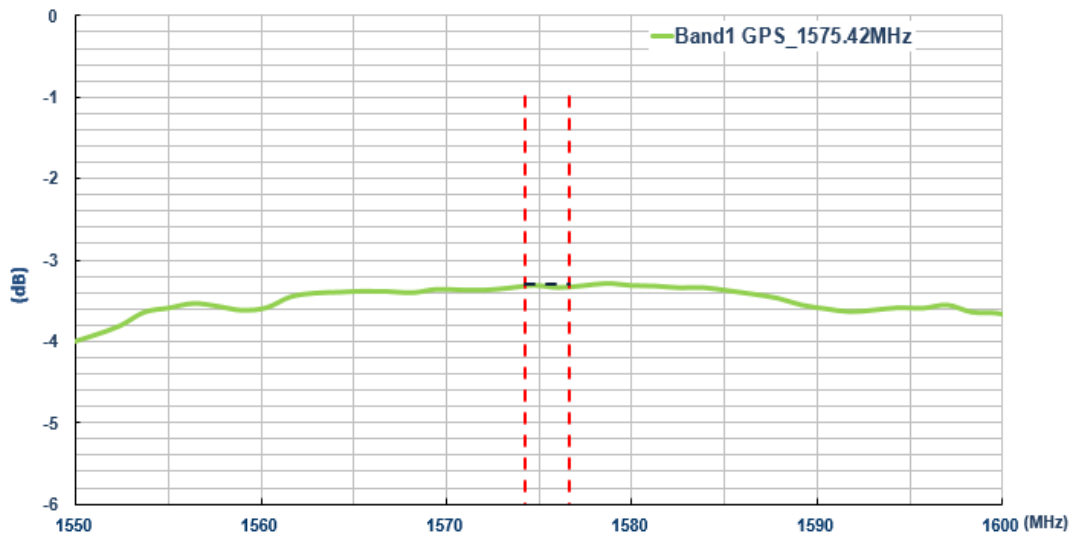

Insertion Loss(dB)
1574.22~1576.62MHz
> -3.3

### 3.5. Common Port to Band 1 Port \_1227.6MHz Attenuation

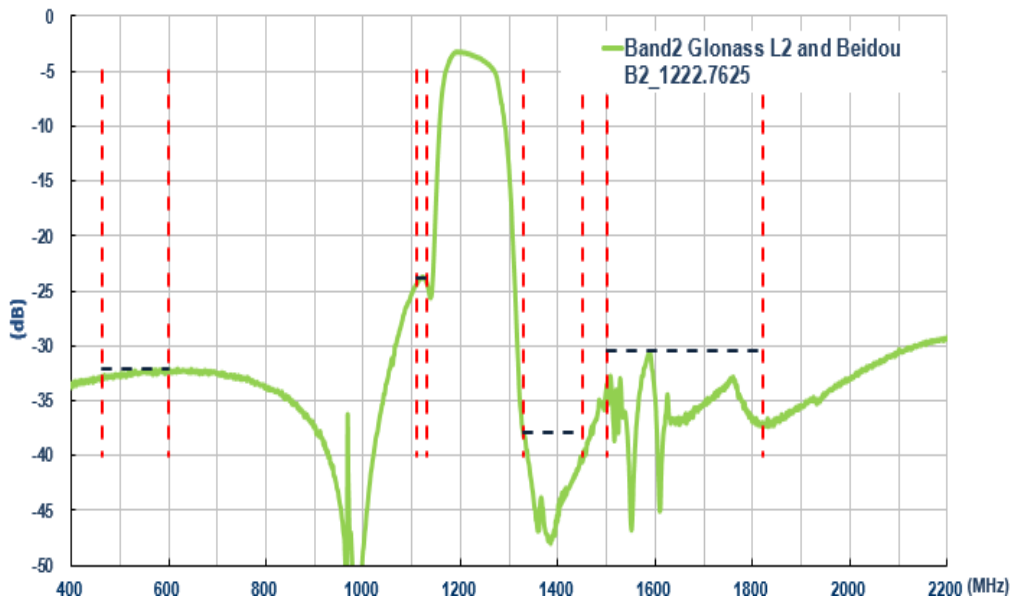

Attenuation (dB)			
<b>464~600MHz</b>	<b>1110~1130MHz</b>	<b>1330~1450MHz</b>	<b>1500~1820MHz</b>
<-32.1	<-23.8	<-37.9	<-30.5

### 3.6. Common Port to Band 1 Port \_1227.6MHz Insertion Loss

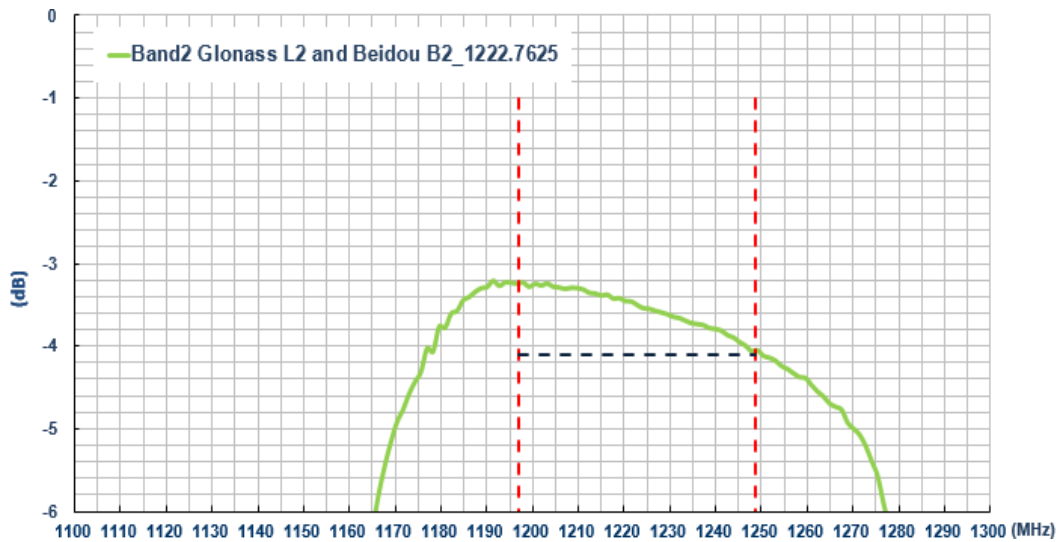

Insertion Loss(dB)
1196.9~1248.625MHz
> -4.1

### 3.7. Band1 Port – Band2 Port Isolation

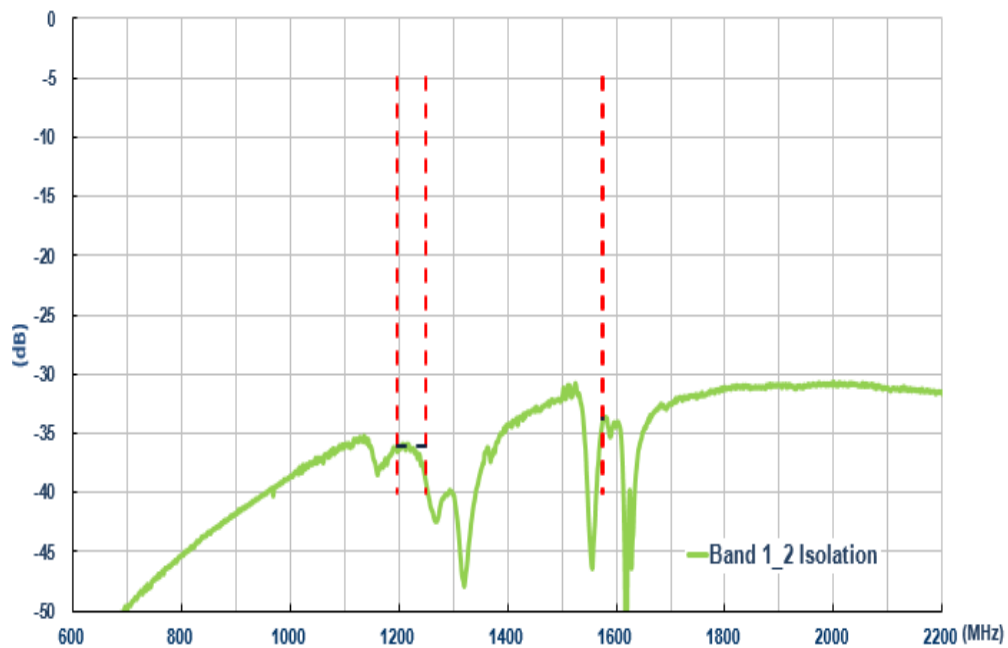

Isolation (dB)	
<b>Band 1</b> 1196.5~1248.625MHz	<b>Band 2</b> 1574.22~1576.62MHz
< -36.1	< -33.8

## 4. Drawing (Unit: mm)

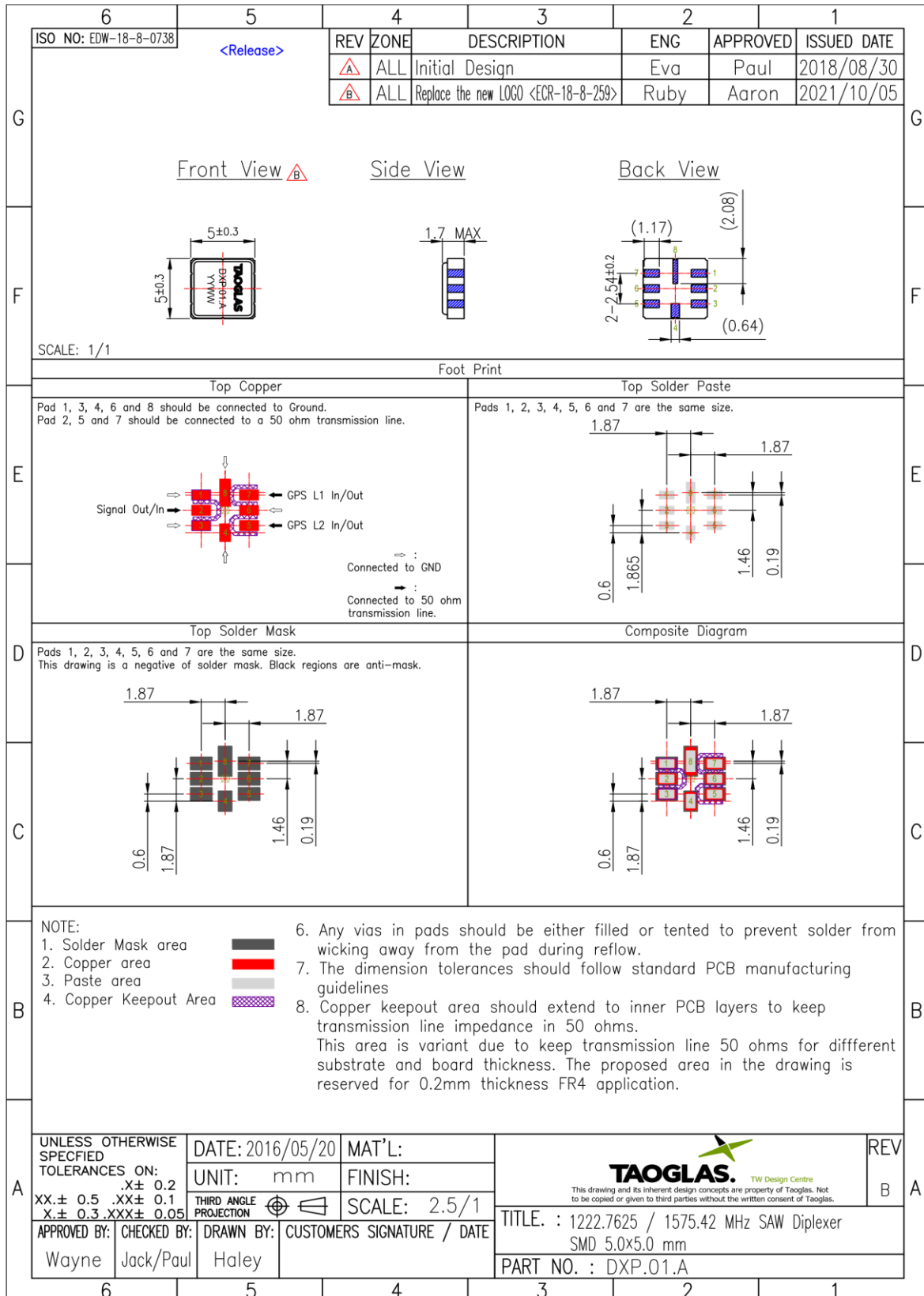



## 5. Recommended Reflow Profile

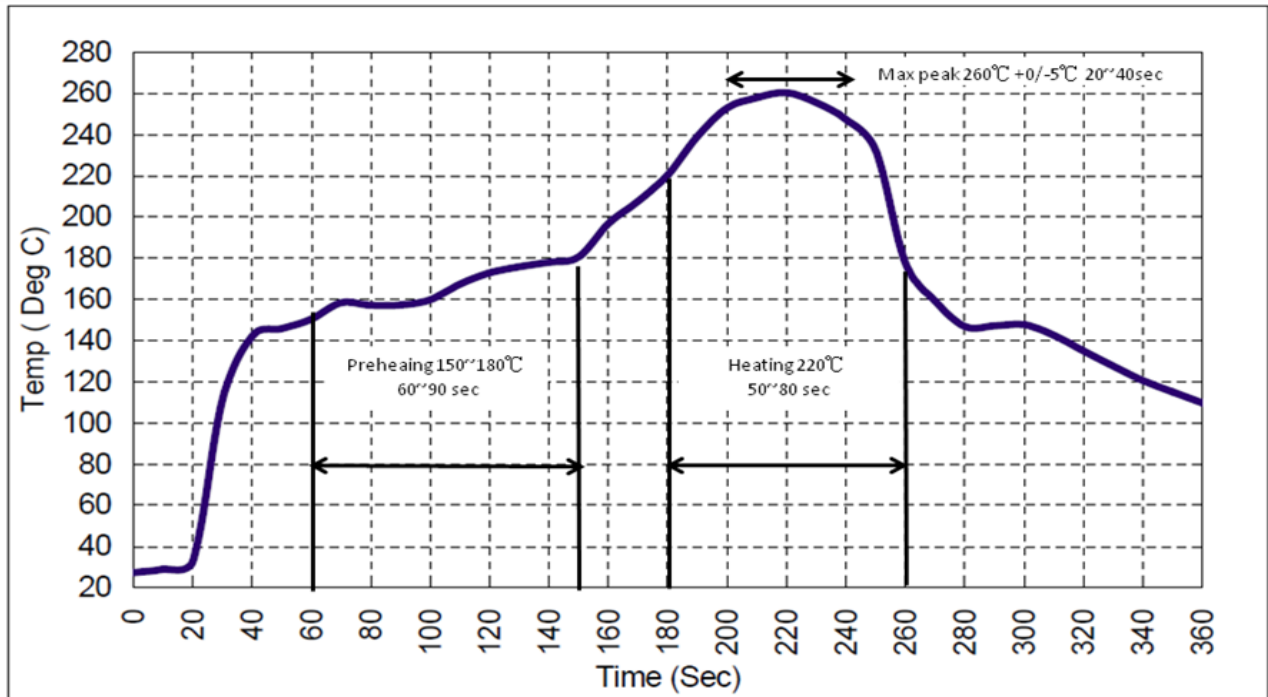

1. Preheating shall be fixed at 150~180°C for 60~90 seconds.
2. Ascending time to preheating temperature 150°C shall be 30 seconds minimum.
3. Heating shall be fixed at 220°C for 50~80 seconds and 260°C as the peak for 20-40 seconds.
4. Time: 2 times.



Packaging Detail

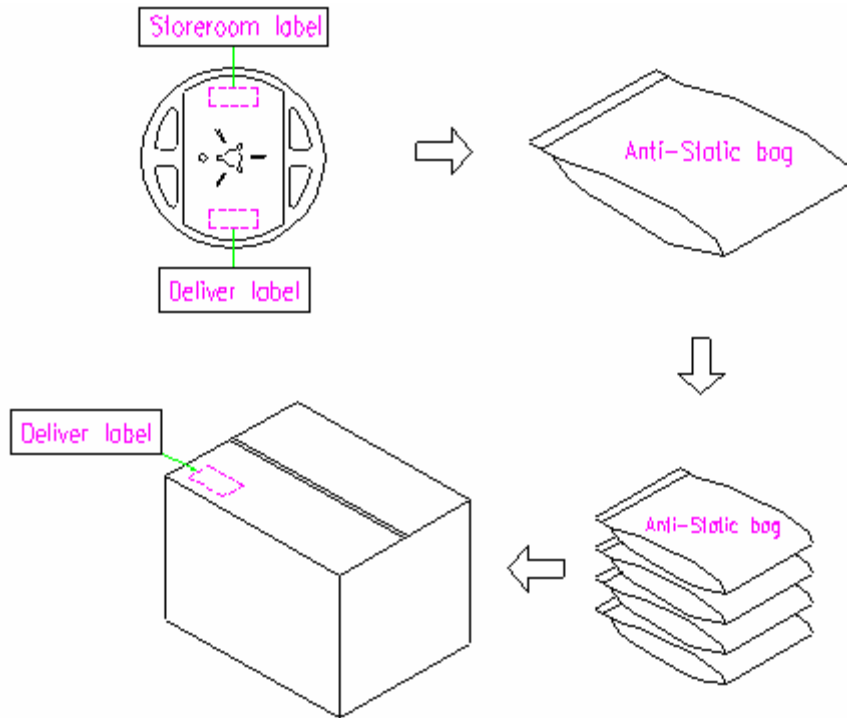

**1k pieces per reel, 4 reels per carton.**

Taoglas makes no warranties based on the accuracy or completeness of the contents of this document and reserves the right to make changes to specifications and product descriptions at any time without notice. Taoglas reserves all rights to this document and the information contained herein.

Reproduction, use or disclosure to third parties without express permission is strictly prohibited.

© Taoglas