

NCP1422

Boost Converter - Sync-Rect, PFM, DC-DC, True-Cutoff, Ring-Killer 800 mA

NCP1422 is a monolithic micropower high-frequency step-up switching converter IC specially designed for battery-operated hand-held electronic products up to 800 mA loading. It integrates Sync-Rect to improve efficiency and to eliminate the external Schottky Diode. High switching frequency (up to 1.2 MHz) allows for a low profile, small-sized inductor and output capacitor to be used. When the device is disabled, the internal conduction path from LX or BAT to OUT is fully blocked and the OUT pin is isolated from the battery. This True-Cutoff function reduces the shutdown current to typically only 50 nA. Ring-Killer is also integrated to eliminate the high-frequency ringing in discontinuous conduction mode. In addition to the above, Low-Battery Detector, Logic-Controlled Shutdown, Cycle-by-Cycle Current Limit and Thermal Shutdown provide value-added features for various battery-operated applications. With all these functions on, the quiescent supply current is typically only 8.5 μ A. This device is available in the compact and low profile DFN-10 package.

Features

- High Efficiency: 94% for 3.3 V Output at 200 mA from 2.5 V Input
88% for 3.3 V Output at 500 mA from 2.5 V Input
- High Switching Frequency, up to 1.2 MHz (not hitting current limit)
- Output Current up to 800 mA at $V_{IN} = 2.5$ V and $V_{OUT} = 3.3$ V
- True-Cutoff Function Reduces Device Shutdown Current to typically 50 nA
- Anti-Ringing Ring-Killer for Discontinuous Conduction Mode
- High Accuracy Reference Output, 1.20 V \pm 1.5% @ 25°C, can Supply 2.5 mA Loading Current when $V_{OUT} > 3.3$ V
- Low Quiescent Current of 8.5 μ A
- Integrated Low-Battery Detector
- Open Drain Low-Battery Detector Output
- 1.0 V Startup at No Load Guaranteed
- Output Voltage from 1.5 V to 5.0 V Adjustable
- 1.5 A Cycle-by-Cycle Current Limit
- Multi-Function Logic-Controlled Shutdown Pin
- On Chip Thermal Shutdown with Hysteresis
- Pb-Free Package is Available*

Typical Applications

- Personal Digital Assistants (PDA)
- Handheld Digital Audio Products
- Camcorders and Digital Still Cameras
- Hand-held Instruments
- Conversion from one to two Alkaline, NiMH, NiCd Battery Cells to 3.0–5.0 V or one Lithium-ion cells to 5.0 V
- White LED Flash for Digital Cameras



ON Semiconductor®

<http://onsemi.com>

MARKING DIAGRAM



DFN-10
MN SUFFIX
CASE 485C

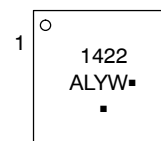

1422 = Device Code
A = Assembly Location
L = Wafer Lot
Y = Year
W = Work Week
▪ = Pb-Free Package
(Note: Microdot may be in either location)

PIN CONNECTIONS

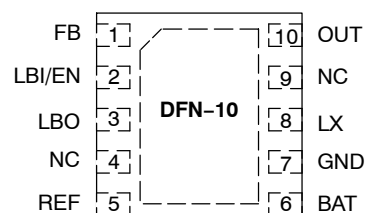

(Top View)

ORDERING INFORMATION

Device	Package	Shipping†
NCP1422MNR2	DFN-10	3000 Tape & Reel
NCP1422MNR2G	DFN-10 (Pb-Free)	3000 Tape & Reel

†For information on tape and reel specifications, including part orientation and tape sizes, please refer to our Tape and Reel Packaging Specifications Brochure, BRD8011/D.

*For additional information on our Pb-Free strategy and soldering details, please download the ON Semiconductor Soldering and Mounting Techniques Reference Manual, SOLDERRM/D.

NCP1422

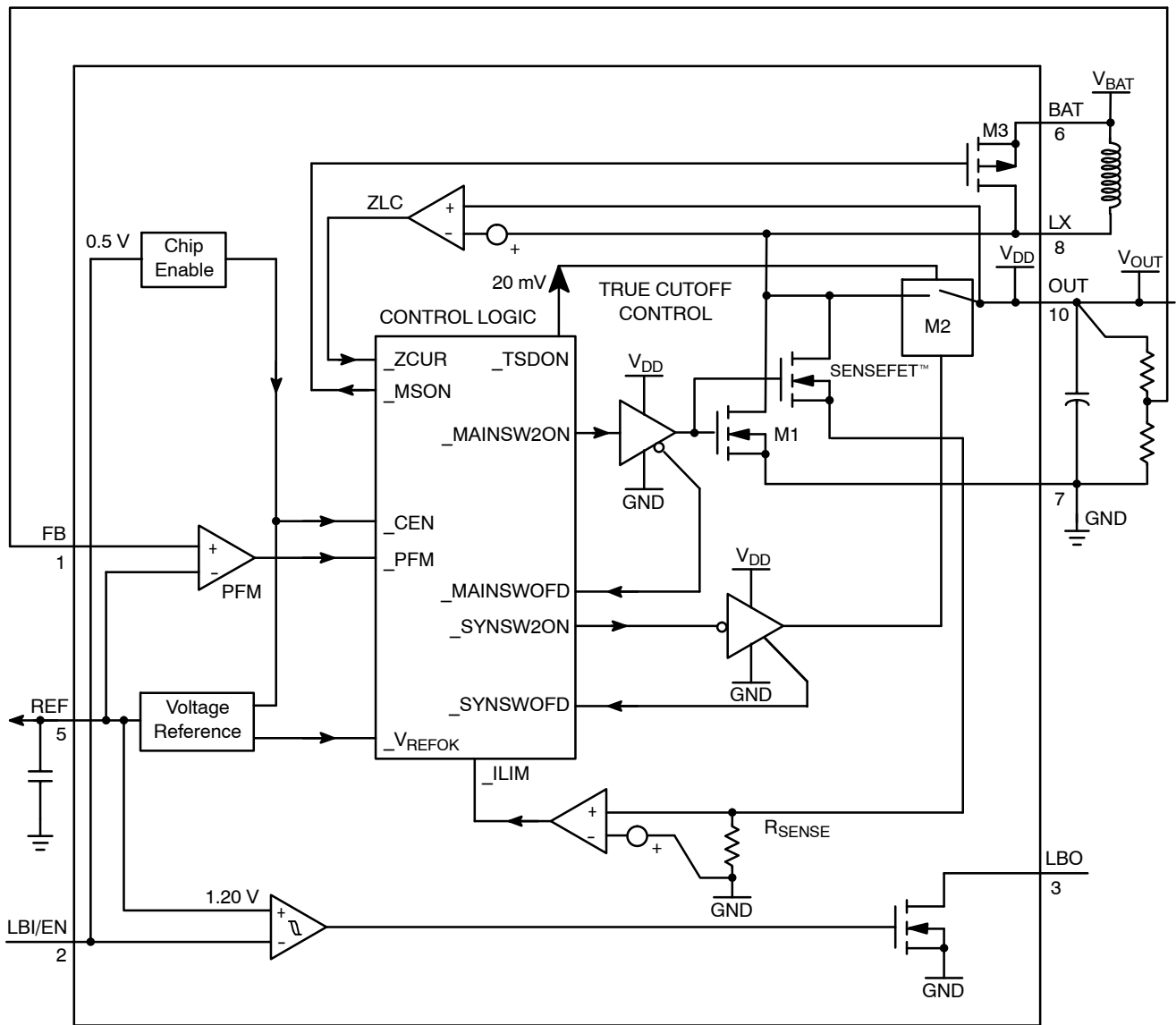

Figure 1. Detailed Block Diagram

NCP1422

PIN FUNCTION DESCRIPTIONS

Pin	Symbol	Description
1	FB	Output Voltage Feedback Input.
2	LBI/EN	Low-Battery Detector Input and IC Enable. With this pin pulled down below 0.5 V, the device is disabled and enters the shutdown mode.
3	LBO	Open-Drain Low-Battery Detector Output. Output is LOW when $V_{LBI} < 1.20$ V. LBO is high impedance in shutdown mode.
4	NC	No Connect Pin
5	REF	1.20 V Reference Voltage Output, bypass with 300 nF capacitor. If this pin is loaded, bypass with 1.0 μ F capacitor; this pin can be loaded up to 2.5 mA @ $V_{OUT} = 3.3$ V.
6	BAT	Battery input connection for internal ring-killer.
7	GND	Ground.
8	LX	N-Channel and P-Channel Power MOSFET drain connection.
9	NC	No Connect Pin
10	OUT	Power Output. OUT also provides bootstrap power to the device.

MAXIMUM RATINGS ($T_A = 25^\circ\text{C}$ unless otherwise noted.)

Rating	Symbol	Value	Unit
Power Supply (Pin 10)	V_{OUT}	-0.3, 5.5	V
Input/Output Pins (Pin 1-3, Pin 5-8)	V_{IO}	-0.3, 5.5	V
Thermal Characteristics DFN-10 Plastic Package Thermal Resistance Junction-to-Air (Note 5)	P_D R_{JA}	1824 68.5	mW° C/W
Operating Junction Temperature Range	T_J	-40 to +150	°C
Operating Ambient Temperature Range	T_A	-40 to +85	°C
Storage Temperature Range	T_{stg}	-55 to +150	°C

Maximum ratings are those values beyond which device damage can occur. Maximum ratings applied to the device are individual stress limit values (not normal operating conditions) and are not valid simultaneously. If these limits are exceeded, device functional operation is not implied, damage may occur and reliability may be affected.

- This device contains ESD protection and exceeds the following tests:
Human Body Model (HBM) ± 2.0 kV per JEDEC standard: JESD22-A114. *Except OUT pin, which is 1k V.
Machine Model (MM) ± 200 V per JEDEC standard: JESD22-A115. *Except OUT pin, which is 100 V.
- The maximum package power dissipation limit must not be exceeded.

$$P_D = \frac{T_{J(max)} - T_A}{R_{\theta JA}}$$

- Latchup Current Maximum Rating: ± 150 mA per JEDEC standard: JESD78.
- Moisture Sensitivity Level: MSL 1 per IPC/JEDEC standard: J-STD-020A.
- Measured on approximately 1x1 inch sq. of 1 oz. Copper.

NCP1422

ELECTRICAL CHARACTERISTICS ($V_{OUT} = 3.3\text{ V}$, $T_A = 25^\circ\text{C}$ for typical value, $-40^\circ\text{C} \leq T_A \leq 85^\circ\text{C}$ for min/max values unless otherwise noted.)

Characteristic	Symbol	Min	Typ	Max	Unit
Operating Voltage	V_{IN}	1.0	–	5.0	V
Output Voltage Range	V_{OUT}	1.5	–	5.0	V
Reference Voltage ($V_{OUT} = 3.3\text{ V}$, $I_{LOAD} = 0\ \mu\text{A}$, $C_{REF} = 200\ \text{nF}$, $T_A = 25^\circ\text{C}$)	V_{REF_NL}	1.183	1.200	1.217	V
Reference Voltage ($V_{OUT} = 3.3\text{ V}$, $I_{LOAD} = 0\ \mu\text{A}$, $C_{REF} = 200\ \text{nF}$, $T_A = -40^\circ\text{C}$ to 85°C)	V_{REF_NL}	1.174	–	1.220	V
Reference Voltage Temperature Coefficient	TC_{VREF}	–	0.03	–	mV/°C
Reference Voltage Load Current ($V_{OUT} = 3.3\text{ V}$, $V_{REF} = V_{REF_NL} \pm 1.5\%$, $C_{REF} = 1.0\ \mu\text{F}$) (Note 6)	I_{REF}	–	2.5	–	mA
Reference Voltage Load Regulation ($V_{OUT} = 3.3\text{ V}$, $I_{LOAD} = 0$ to $100\ \mu\text{A}$, $C_{REF} = 1.0\ \mu\text{F}$)	V_{REF_LOAD}	–	0.05	1.0	mV
Reference Voltage Line Regulation (V_{OUT} from 1.5 V to 5.0 V , $C_{REF} = 1.0\ \mu\text{F}$)	V_{REF_LINE}	–	0.05	1.0	mV/V
FB Input Threshold ($I_{LOAD} = 0\ \text{mA}$, $T_A = 25^\circ\text{C}$)	V_{FB}	1.192	1.200	1.208	V
FB Input Threshold ($I_{LOAD} = 0\ \text{mA}$, $T_A = -40^\circ\text{C}$ to 85°C)	V_{FB}	1.184	–	1.210	V
LBI Input Threshold ($I_{LOAD} = 0\ \text{mA}$, $T_A = 25^\circ\text{C}$)	V_{LBI}	1.182	1.200	1.218	V
LBI Input Threshold ($I_{LOAD} = 0\ \text{mA}$, $T_A = -40^\circ\text{C}$ to 85°C)	V_{LBI}	1.162	–	1.230	V
Internal N-FET ON-Resistance	$R_{DS(ON)_N}$	–	0.3	–	Ω
Internal P-FET ON-Resistance	$R_{DS(ON)_P}$	–	0.3	–	Ω
LX Switch Current Limit (N-FET) (Note 8)	I_{LIM}	–	1.5	–	A
Operating Current into BAT ($V_{BAT} = 1.8\text{ V}$, $V_{FB} = 1.8\text{ V}$, $V_{LX} = 1.8\text{ V}$, $V_{OUT} = 3.3\text{ V}$)	I_{QBAT}	–	1.3	3.0	μA
Operating Current into OUT ($V_{FB} = 1.4\text{ V}$, $V_{OUT} = 3.3\text{ V}$)	I_Q	–	8.5	14	μA
LX Switch MAX. ON-Time ($V_{FB} = 1.0\text{ V}$, $V_{OUT} = 3.3\text{ V}$, $T_A = 25^\circ\text{C}$)	t_{ON}	0.46	0.72	1.15	μs
LX Switch MIN. OFF-Time ($V_{FB} = 1.0\text{ V}$, $V_{OUT} = 3.3\text{ V}$, $T_A = 25^\circ\text{C}$)	t_{OFF}	–	0.12	0.22	μs
FB Input Current	I_{FB}	–	1.0	50	nA
True-Cutoff Current into BAT ($LBI/EN = GND$, $V_{OUT} = 0\text{ V}$, $V_{IN} = 3.3\text{ V}$, $LX = 3.3\text{ V}$)	I_{BAT_SD}	–	50	–	nA
BAT-to-LX Resistance ($V_{FB} = 1.4\text{ V}$, $V_{OUT} = 3.3\text{ V}$) (Note 8)	R_{BAT_LX}	–	100	–	Ω
LBI/EN Input Current	I_{LBI}	–	1.5	50	nA
LBO Low Output Voltage ($V_{LBI} = 0\text{ V}$, $I_{SINK} = 1.0\text{ mA}$)	V_{LBO_L}	–	–	0.2	V
Soft-Start Time ($V_{IN} = 2.5\text{ V}$, $V_{OUT} = 5.0\text{ V}$, $C_{REF} = 200\ \text{nF}$) (Note 7)	T_{SS}	–	1.5	20	ms
EN Pin Shutdown Threshold ($T_A = 25^\circ\text{C}$)	V_{SHDN}	0.35	0.5	0.67	V
Thermal Shutdown Temperature (Note 8)	T_{SHDN}	–	–	145	°C
Thermal Shutdown Hysteresis (Note 8)	T_{SDHYS}	–	30	–	°C

6. Loading capability increases with V_{OUT} .

7. Design guarantee, value depends on voltage at V_{OUT} .

8. Values are design guaranteed.

TYPICAL OPERATING CHARACTERISTICS

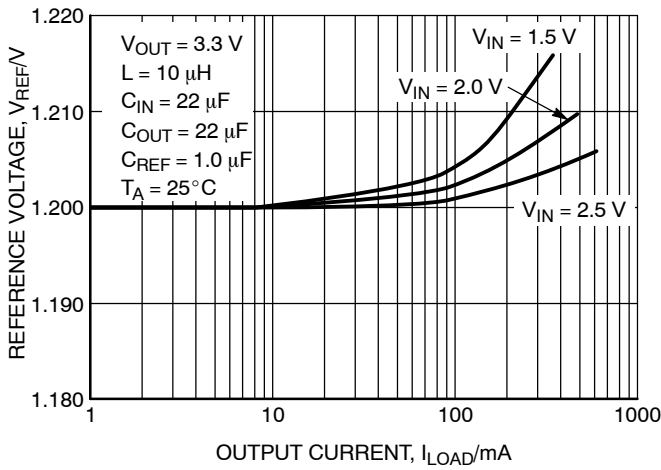

Figure 2. Reference Voltage vs. Output Current

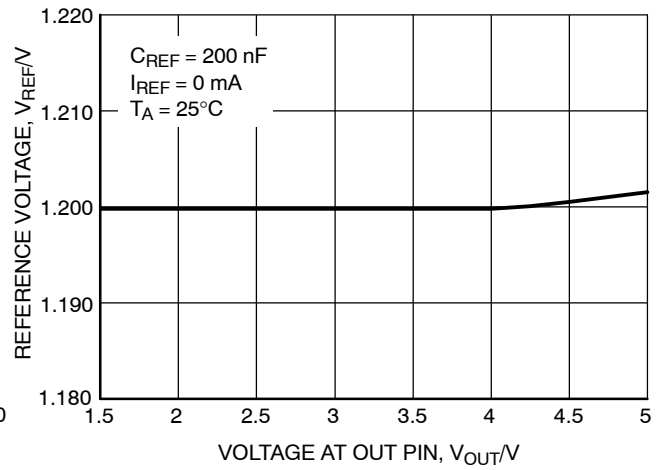

Figure 3. Reference Voltage vs. Voltage at OUT Pin

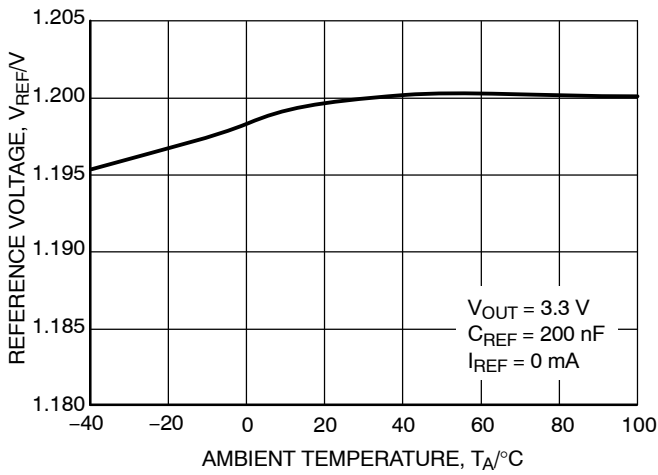

Figure 4. Reference Voltage vs. Temperature

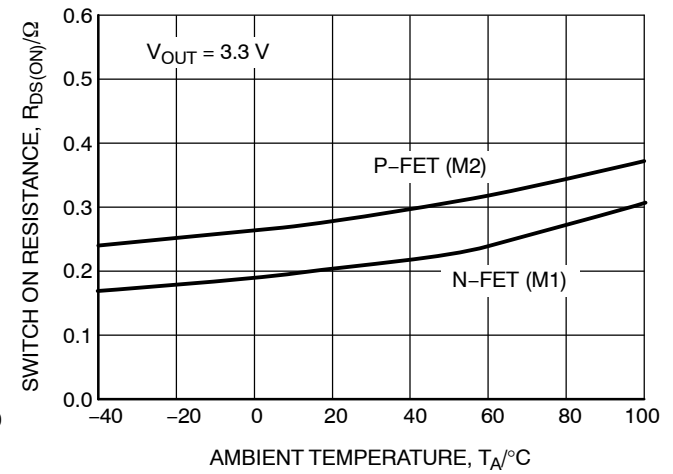

Figure 5. Switch ON Resistance vs. Temperature

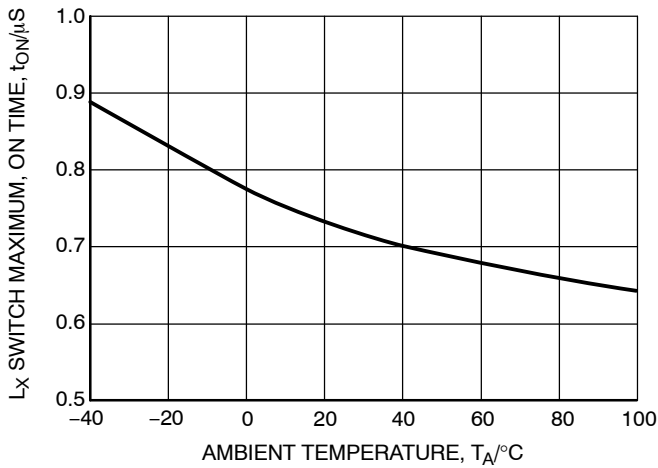

Figure 6. L_x Switch Max. ON Time vs. Temperature

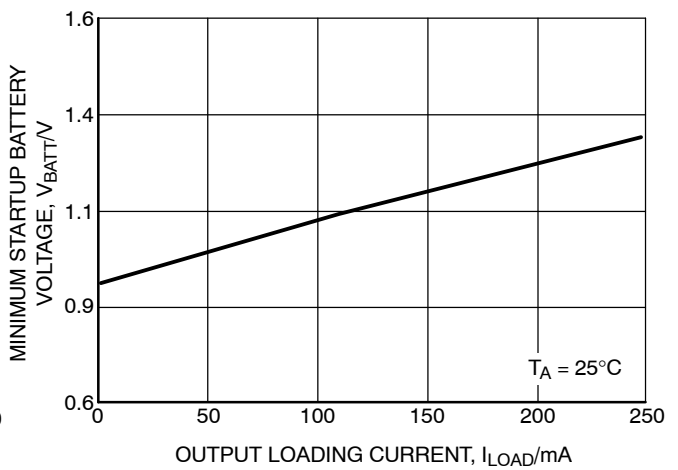

Figure 7. Minimum Startup Battery Voltage vs. Loading Current

TYPICAL OPERATING CHARACTERISTICS

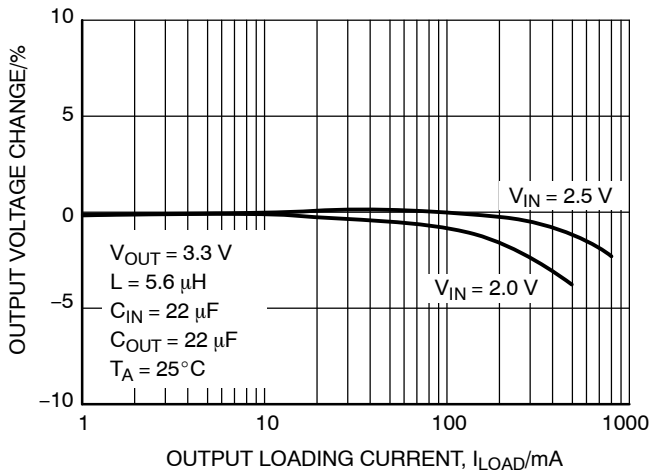

Figure 8. Output Voltage Change vs. Load Current

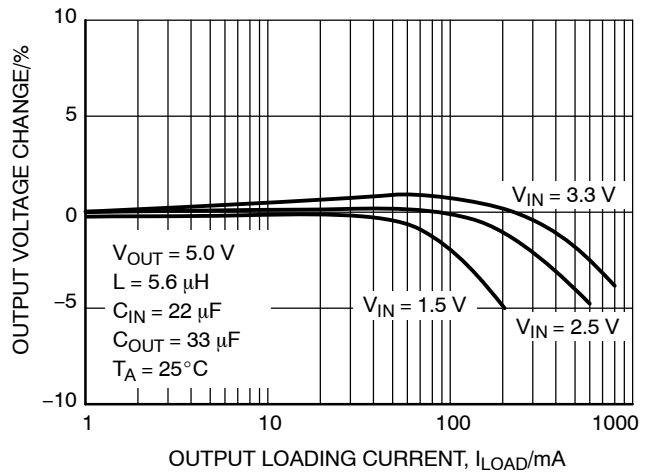

Figure 9. Output Voltage Change vs. Load Current

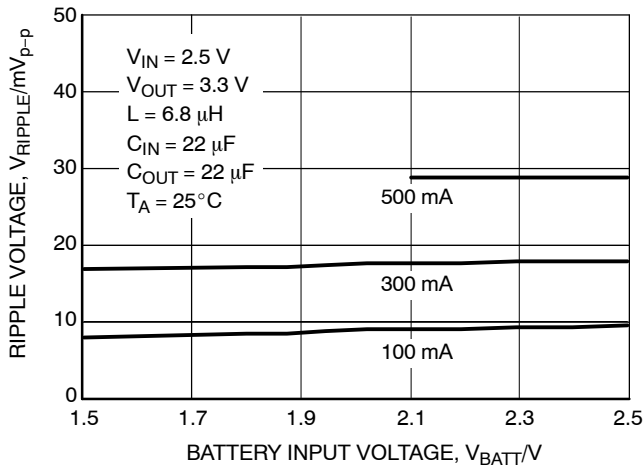
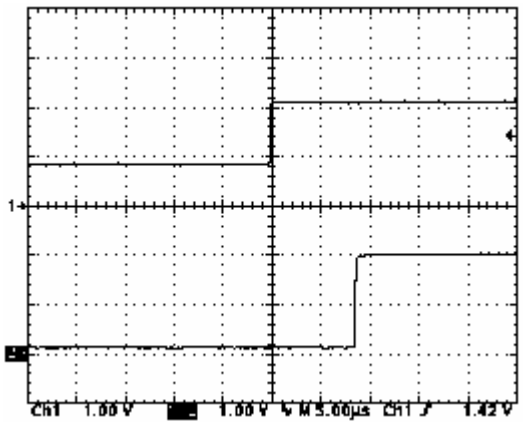

Figure 10. Battery Input Voltage vs. Output Ripple Voltage



Upper Trace: Voltage at LBI Pin, 1.0 V/Division
Lower Trace: Voltage at LBO Pin, 1.0 V/Division

Figure 11. Low Battery Detect

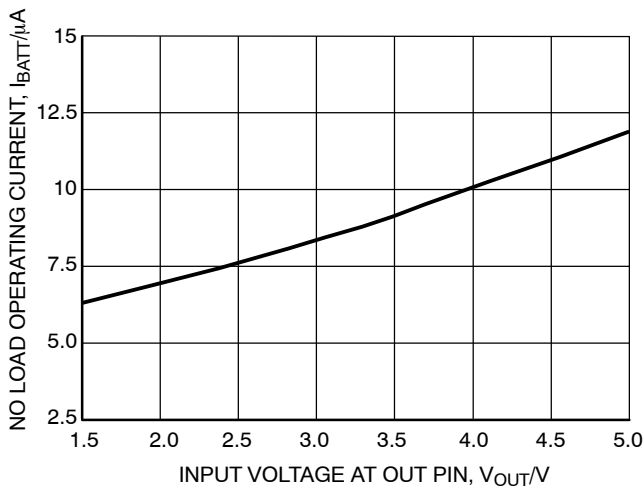
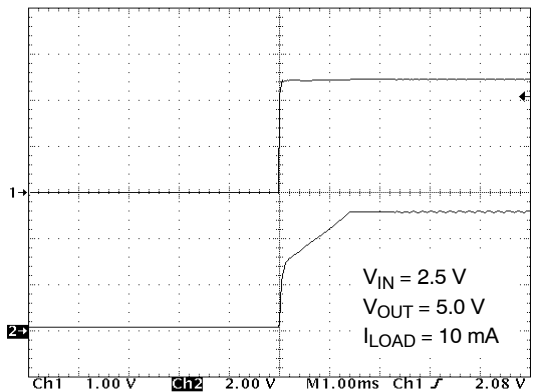

Figure 12. No Load Operating Current vs. Input Voltage at OUT Pin



Upper Trace: Input Voltage Waveform, 1.0 V/Division
Lower Trace: Output Voltage Waveform, 2.0 V/Division

Figure 13. Startup Transient Response

TYPICAL OPERATING CHARACTERISTICS

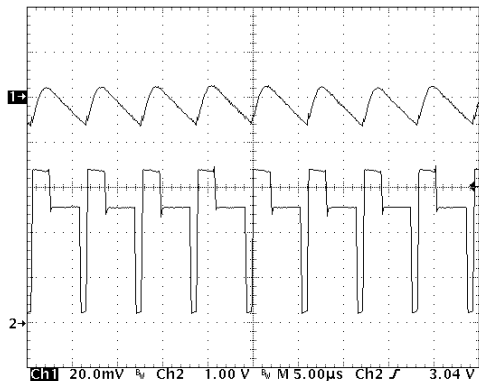

($V_{IN} = 2.5\text{ V}$, $V_{OUT} = 3.3\text{ V}$, $I_{LOAD} = 50\text{ mA}$; $L = 5.6\text{ }\mu\text{H}$)
 Upper Trace: Output Voltage Ripple, 20 mV/Division
 Lower Trace: Voltage at Lx pin, 1.0 V/Division

Figure 14. Discontinuous Conduction Mode Switching Waveform

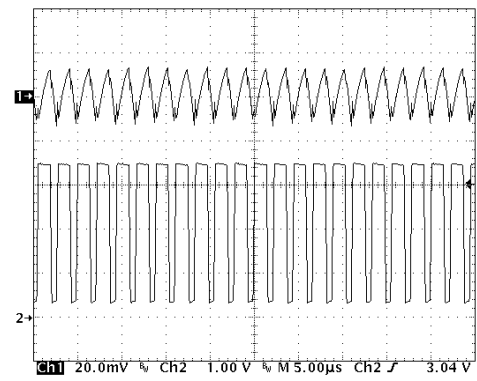

($V_{IN} = 2.5\text{ V}$, $V_{OUT} = 3.3\text{ V}$, $I_{LOAD} = 500\text{ mA}$; $L = 5.6\text{ }\mu\text{H}$)
 Upper Trace: Output Voltage Ripple, 20 mV/Division
 Lower Trace: Voltage at LX pin, 1.0 V/Division

Figure 15. Continuous Conduction Mode Switching Waveform

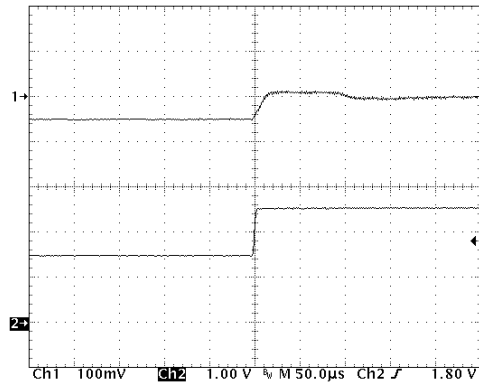

($V_{IN} = 1.5\text{ V to } 2.5\text{ V}$; $L = 5.6\text{ }\mu\text{H}$, $C_{OUT} = 22\text{ }\mu\text{F}$, $I_{LOAD} = 100\text{ mA}$)
 Upper Trace: Output Voltage Ripple, 100 mV/Division
 Lower Trace: Battery Voltage, V_{IN} , 1.0 V/Division

Figure 16. Line Transient Response for $V_{OUT} = 3.3\text{ V}$

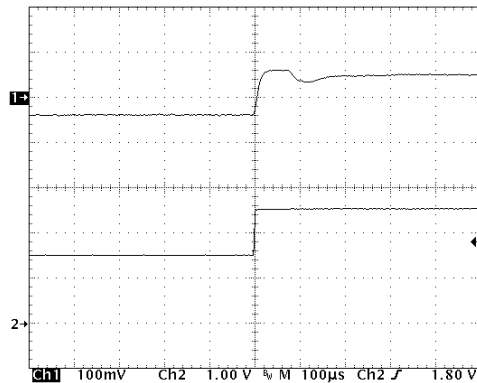

($V_{IN} = 1.5\text{ V to } 2.5\text{ V}$; $L = 5.6\text{ }\mu\text{H}$, $C_{OUT} = 22\text{ }\mu\text{F}$, $I_{LOAD} = 100\text{ mA}$)
 Upper Trace: Output Voltage Ripple, 100 mV/Division
 Lower Trace: Battery Voltage, V_{IN} , 1.0 V/Division

Figure 17. Line Transient Response For $V_{OUT} = 5.0\text{ V}$

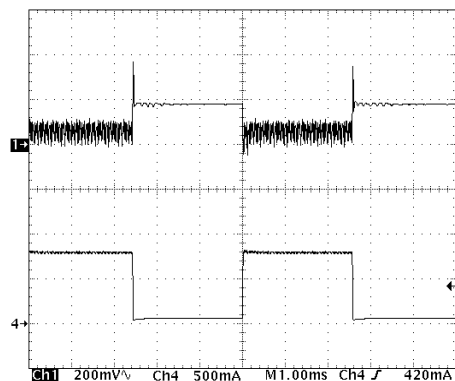

($V_{OUT} = 3.3\text{ V}$, $I_{LOAD} = 100\text{ mA to } 800\text{ mA}$; $L = 5.6\text{ }\mu\text{H}$, $C_{OUT} = 22\text{ }\mu\text{F}$)
 Upper Trace: Output Voltage Ripple, 200 mV/Division
 Lower Trace: Load Current, I_{LOAD} , 500 mA/Division

Figure 18. Load Transient Response For $V_{IN} = 2.5\text{ V}$

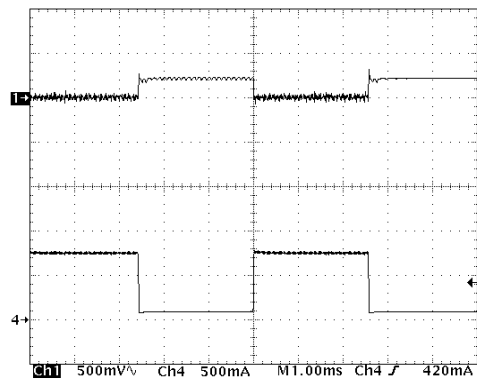

($V_{OUT} = 5.0\text{ V}$, $I_{LOAD} = 100\text{ mA to } 800\text{ mA}$; $L = 5.6\text{ }\mu\text{H}$, $C_{OUT} = 22\text{ }\mu\text{F}$)
 Upper Trace: Output Voltage Ripple, 500 mV/Division
 Lower Trace: Load Current, I_{LOAD} , 500 mA/Division

Figure 19. Load Transient Response For $V_{IN} = 3.0\text{ V}$

NCP1422

TYPICAL OPERATING CHARACTERISTICS

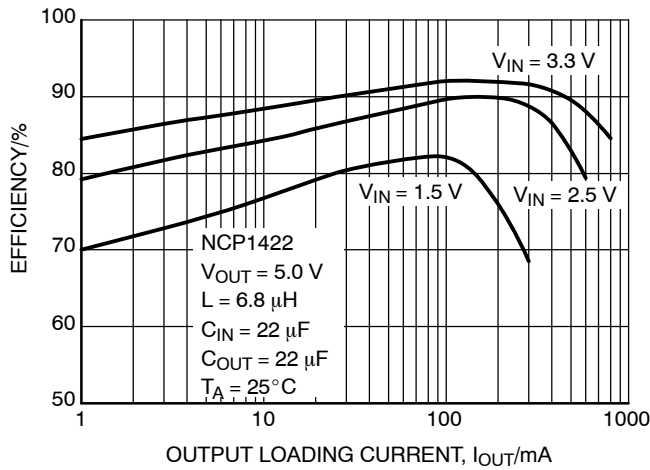

Figure 20. Efficiency vs. Load Current

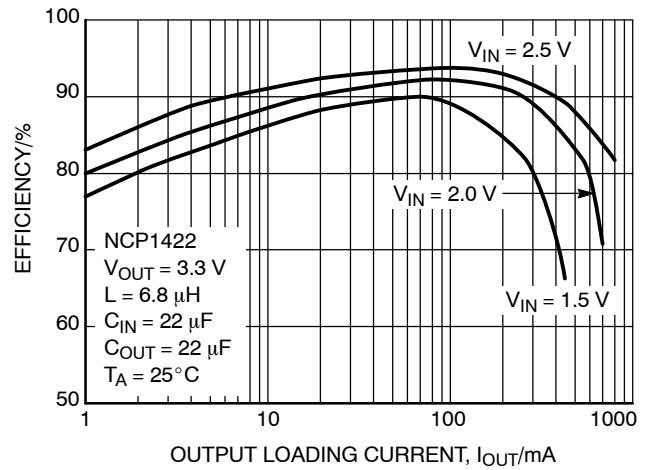

Figure 21. Efficiency vs. Load Current

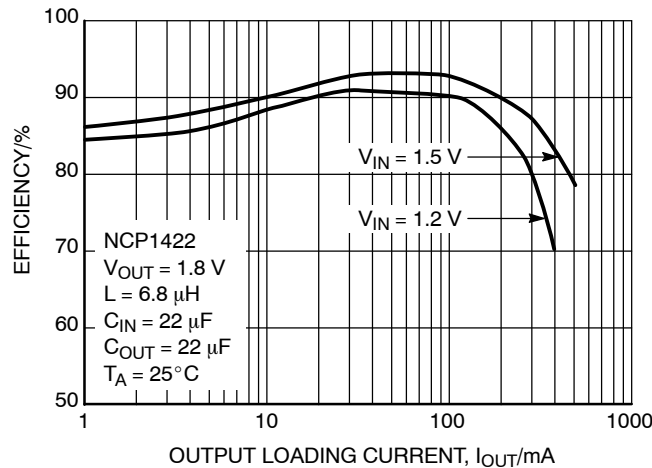

Figure 22. Efficiency vs. Load Current

DETAILED OPERATION DESCRIPTION

NCP1422 is a monolithic micropower high-frequency step-up voltage switching converter IC specially designed for battery operated hand-held electronic products up to 800 mA loading. It integrates a Synchronous Rectifier to improve efficiency as well as to eliminate the external Schottky diode. High switching frequency (up to 1.2 MHz) allows for a low profile inductor and output capacitor to be used. Low-Battery Detector, Logic-Controlled Shutdown, and Cycle-by-Cycle Current Limit provide value-added features for various battery-operated applications. With all these functions ON, the quiescent supply current is typically only 8.5 μA . This device is available in a compact DFN-10 package.

PFM Regulation Scheme

From the simplified functional diagram (Figure 1), the output voltage is divided down and fed back to pin 1 (FB). This voltage goes to the non-inverting input of the PFM comparator whereas the comparator's inverting input is connected to the internal voltage reference, REF. A switching cycle is initiated by the falling edge of the comparator, at the moment the main switch (M1) is turned ON. After the maximum ON-time (typically 0.72 μs) elapses or the current limit is reached, M1 is turned OFF and the synchronous switch (M2) is turned ON. The M1 OFF time is not less than the minimum OFF-time (typically 0.12 μs), which ensures complete energy

transfer from the inductor to the output capacitor. If the regulator is operating in Continuous Conduction Mode (CCM), M2 is turned OFF just before M1 is supposed to be ON again. If the regulator is operating in Discontinuous Conduction Mode (DCM), which means the coil current will decrease to zero before the new cycle starts, M1 is turned OFF as the coil current is almost reaching zero. The comparator (ZLC) with fixed offset is dedicated to sense the voltage drop across M2 as it is conducting; when the voltage drop is below the offset, the ZLC comparator output goes HIGH and M2 is turned OFF. Negative feedback of closed-loop operation regulates voltage at pin1 (FB) equal to the internal reference voltage (1.20 V).

Synchronous Rectification

The Synchronous Rectifier is used to replace the Schottky Diode to reduce the conduction loss contributed by the forward voltage of the Schottky Diode. The Synchronous Rectifier is normally realized by powerFET with gate control circuitry that incorporates relatively complicated timing concerns.

As the main switch (M1) is being turned OFF and the synchronous switch M2 is just turned ON with M1 not being completely turned OFF, current is shunt from the output bulk capacitor through M2 and M1 to ground. This power loss lowers overall efficiency and possibly damages the switching FETs. As a general practice, a certain amount of dead time is introduced to make sure M1 is completely turned OFF before M2 is turned ON.

The previously mentioned situation occurs when the regulator is operating in CCM, M2 is turned OFF, M1 is just turned ON, and M2 is not completely turned OFF. A dead time is also needed to make sure M2 is completely turned OFF before M1 is turned ON.

As coil current is dropped to zero when the regulator is operating in DCM, M2 should be OFF. If this does not occur, the reverse current flows from the output bulk capacitor through M2 and the inductor to the battery input, causing damage to the battery. The ZLC comparator comes with fixed offset voltage to switch M2 OFF before any reverse current builds up. However, if M2 is switched OFF too early, large residue coil current flows through the body diode of M2 and increases conduction loss. Therefore, determination of the offset voltage is essential for optimum performance. With the implementation of the synchronous rectification scheme, efficiency can be as high as 94% with this device.

Cycle-by-Cycle Current Limit

In Figure 1, a SENSEFET is used to sample the coil current as M1 is ON. With that sample current flowing through a sense resistor, a sense-voltage is developed. The threshold detector (I_{LIM}) detects whether the sense-voltage is higher than the preset level. If the sense voltage is higher than the present level, the detector output notifies the Control Logic to switch OFF M1, and M1 can only be switched ON when the next cycle starts after the minimum OFF-time (typically 0.12 μ S). With proper sizing of the SENSEFET and sense resistor, the peak coil current limit is typically set at 1.5 A.

Voltage Reference

The voltage at REF is typically set at 1.20 V and can output up to 2.5 mA with load regulation $\pm 2\%$ at V_{OUT} equal to 3.3 V. If V_{OUT} is increased, the REF load capability can also be increased. A bypass capacitor of 200 nF is required for proper operation when REF is not loaded. If REF is loaded, a 1.0 μ F capacitor at the REF pin is needed.

True-Cutoff

The NCP1422 has a True-Cutoff function controlled by the multi-function pin LBI/EN (pin 2). Internal circuitry can isolate the current through the body diode of switch M2 to load. Thus, it can eliminate leakage current from the battery to load in shutdown mode and significantly reduce battery current consumption during shutdown. The shutdown function is controlled by the voltage at pin 2 (LBI/EN). When pin 2 is pulled to lower than 0.3 V, the controller enters shutdown mode. In shutdown mode, when switches M1 and M2 are both switched OFF, the internal reference voltage of the controller is disabled and the controller typically consumes only 50 nA of current. If the pin 2 voltage is raised to higher than 0.5 V (for example, by a resistor connected to V_{IN}), the IC is enabled again, and the internal circuit typically consumes 8.5 μ A of current from the OUT pin during normal operation.

Low-Battery Detection

A comparator with 30 mV hysteresis is applied to perform the low-battery detection function. When pin 2 (LBI/EN) is at a voltage (defined by a resistor divider from the battery voltage) lower than the internal reference voltage of 1.20 V, the comparator output turns on a 50 Ω low side switch. It pulls down the voltage at pin 3 (LBO) which requires a hundred to a thousand k Ω of external pull-high resistance. If the pin 2 voltage is higher than 1.20 V + 30 mV, the comparator output turns off the 50 Ω low side switch. When this occurs, pin 3 becomes high impedance and its voltage is pulled high again.

APPLICATIONS INFORMATION

Output Voltage Setting

A typical application circuit is shown in Figure 23. The output voltage of the converter is determined by the external feedback network comprised of R1 and R2. The relationship is given by:

$$V_{OUT} = 1.20 \text{ V} \times \left(1 + \frac{R1}{R2}\right)$$

where R1 and R2 are the upper and lower feedback resistors, respectively.

Low Battery Detect Level Setting

The Low Battery Detect Voltage of the converter is determined by the external divider network that is comprised of R3 and R4. The relationship is given by:

$$V_{LB} = 1.20 \text{ V} \times \left(1 + \frac{R3}{R4}\right)$$

where R3 and R4 are the upper and lower divider resistors respectively.

Inductor Selection

The NCP1422 is tested to produce optimum performance with a 5.6 μH inductor at $V_{IN} = 2.5 \text{ V}$ and $V_{OUT} = 3.3 \text{ V}$, supplying an output current up to 800 mA. For other input/output requirements, inductance in the range 3 μH to 10 μH can be used according to end application specifications. Selecting an inductor is a compromise between output current capability, inductor saturation limit, and tolerable output voltage ripple. Low inductance values can supply higher output current but also increase the ripple at output and reduce efficiency. On the other hand, high inductance values can improve output ripple and efficiency; however, it is also limited to the output current capability at the same time.

Another parameter of the inductor is its DC resistance. This resistance can introduce unwanted power loss and reduce overall efficiency. The basic rule is to select an inductor with the lowest DC resistance within the board space limitation of the end application. In order to help with the inductor selection, reference charts are shown in Figures 24 and 25.

Capacitors Selection

In all switching mode boost converter applications, both the input and output terminals see impulsive

voltage/current waveforms. The currents flowing into and out of the capacitors multiply with the Equivalent Series Resistance (ESR) of the capacitor to produce ripple voltage at the terminals. During the Syn–Rect switch–off cycle, the charges stored in the output capacitor are used to sustain the output load current. Load current at this period and the ESR combine and reflect as ripple at the output terminals. For all cases, the lower the capacitor ESR, the lower the ripple voltage at output. As a general guideline, low ESR capacitors should be used. Ceramic capacitors have the lowest ESR, but low ESR tantalum capacitors can also be used as an alternative.

PCB Layout Recommendations

Good PCB layout plays an important role in switching mode power conversion. Careful PCB layout can help to minimize ground bounce, EMI noise, and unwanted feedback that can affect the performance of the converter. Hints suggested below can be used as a guideline in most situations.

Grounding

A star–ground connection should be used to connect the output power return ground, the input power return ground, and the device power ground together at one point. All high–current paths must be as short as possible and thick enough to allow current to flow through and produce insignificant voltage drop along the path. The feedback signal path must be separated from the main current path and sense directly at the anode of the output capacitor.

Components Placement

Power components (i.e., input capacitor, inductor and output capacitor) must be placed as close together as possible. All connecting traces must be short, direct, and thick. High current flowing and switching paths must be kept away from the feedback (FB, pin 1) terminal to avoid unwanted injection of noise into the feedback path.

Feedback Network

Feedback of the output voltage must be a separate trace detached from the power path. The external feedback network must be placed very close to the feedback (FB, pin 1) pin and sense the output voltage directly at the anode of the output capacitor.

NCP1422

TYPICAL APPLICATION CIRCUIT

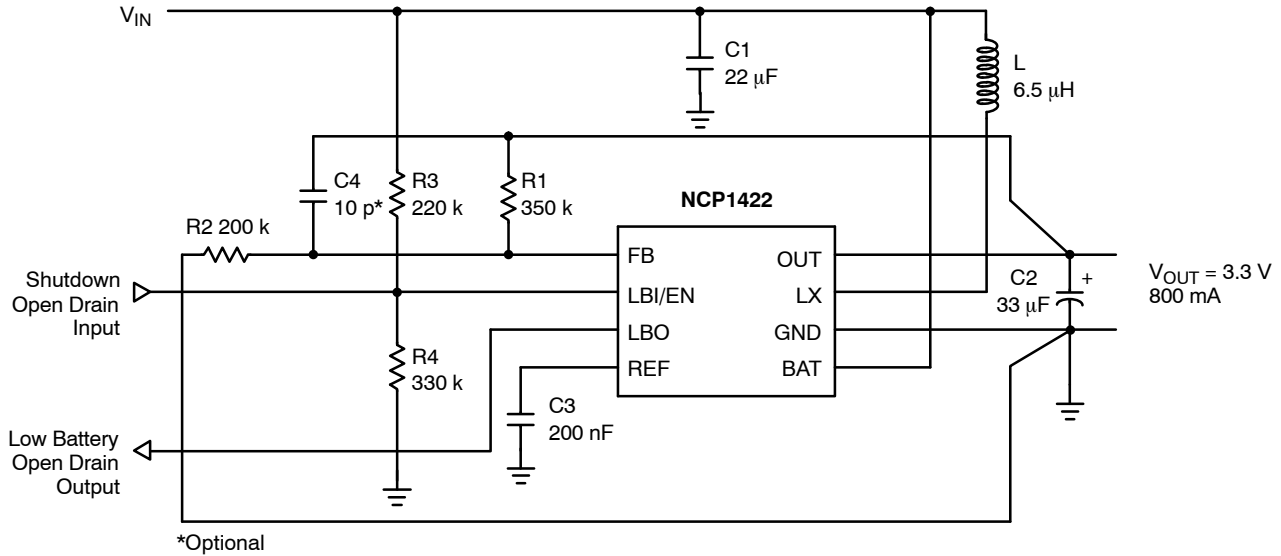

Figure 23. Typical Application Schematic for 2 Alkaline Cells Supply

GENERAL DESIGN PROCEDURES

Switching mode converter design is considered a complicated process. Selecting the right inductor and capacitor values can allow the converter to provide optimum performance. The following is a simple method based on the basic first-order equations to estimate the inductor and capacitor values for NCP1422 to operate in Continuous Conduction Mode (CCM). The set component values can be used as a starting point to fine tune the application circuit performance. Detailed bench testing is still necessary to get the best performance out of the circuit.

Design Parameters:

- $V_{IN} = 1.8 \text{ V to } 3.0 \text{ V, Typical } 2.4 \text{ V}$
- $V_{OUT} = 3.3 \text{ V}$
- $I_{OUT} = 500 \text{ mA}$
- $V_{LB} = 2.0 \text{ V}$
- $V_{OUT-RIPPLE} = 40 \text{ mV}_{P-P} \text{ at } I_{OUT} = 500 \text{ mA}$

Calculate the feedback network:

Select $R_2 = 200 \text{ k}$

$$R_1 = R_2 \left(\frac{V_{OUT}}{V_{REF}} - 1 \right)$$

$$R_1 = 200 \text{ k} \left(\frac{3.3 \text{ V}}{1.20 \text{ V}} - 1 \right) = 350 \text{ k}$$

Calculate the Low Battery Detect divider:

$V_{LB} = 2.0 \text{ V}$
Select $R_4 = 330 \text{ k}$

$$R_3 = R_4 \left(\frac{V_{LB}}{V_{REF}} - 1 \right)$$

$$R_3 = 300 \text{ k} \left(\frac{2.0 \text{ V}}{1.20 \text{ V}} - 1 \right) = 220 \text{ k}$$

Determine the Steady State Duty Ratio, D , for typical V_{IN} . The operation is optimized around this point:

$$\frac{V_{OUT}}{V_{IN}} = \frac{1}{1 - D}$$

$$D = 1 - \frac{V_{IN}}{V_{OUT}} = 1 - \frac{2.4 \text{ V}}{3.3 \text{ V}} = 0.273$$

Determine the average inductor current, I_{LAVG} , at maximum I_{OUT} :

$$I_{LAVG} = \frac{I_{OUT}}{1 - D} = \frac{500 \text{ mA}}{1 - 0.273} = 688 \text{ mA}$$

Determine the peak inductor ripple current, $I_{RIPPLE-P}$, and calculate the inductor value:

Assume $I_{RIPPLE-P}$ is 20% of I_{LAVG} . The inductance of the power inductor can be calculated as follows:

$$L = \frac{V_{IN} \times t_{ON}}{2 I_{RIPPLE-P}} = \frac{2.4 \text{ V} \times 0.75 \mu\text{S}}{2 (137.6 \text{ mA})} = 6.5 \mu\text{H}$$

A standard value of $6.5 \mu\text{H}$ is selected for initial trial.

Determine the output voltage ripple, $V_{OUT-RIPPLE}$, and calculate the output capacitor value:

$V_{OUT-RIPPLE} = 40 \text{ mV}_{P-P} \text{ at } I_{OUT} = 500 \text{ mA}$

$$C_{OUT} > \frac{I_{OUT} \times t_{ON}}{V_{OUT-RIPPLE} - I_{OUT} \times ESR_{COUT}}$$

where $t_{ON} = 0.75 \mu\text{S}$ and $ESR_{COUT} = 0.05 \Omega$,

$$C_{OUT} > \frac{500 \text{ mA} \times 0.75 \mu\text{S}}{45 \text{ mV} - 500 \text{ mA} \times 0.05 \Omega} = 18.75 \mu\text{F}$$

NCP1422

From the previous calculations, you need at least 18.75 μF in order to achieve the specified ripple level at the conditions stated. Practically, a capacitor that is one level larger is used to accommodate factors not taken into account in the calculations. Therefore, a capacitor value of 22 μF is selected. The NCP1422 is internally compensated for most applications, but in case additional compensation

is required, the capacitor C4 can be used as external compensation adjustment to improve system dynamics.

In order to provide an easy way for customers to select external parts for NCP1422 in different input voltage and output current conditions, values of inductance and capacitance are suggested in Figures 24, 25 and 26.

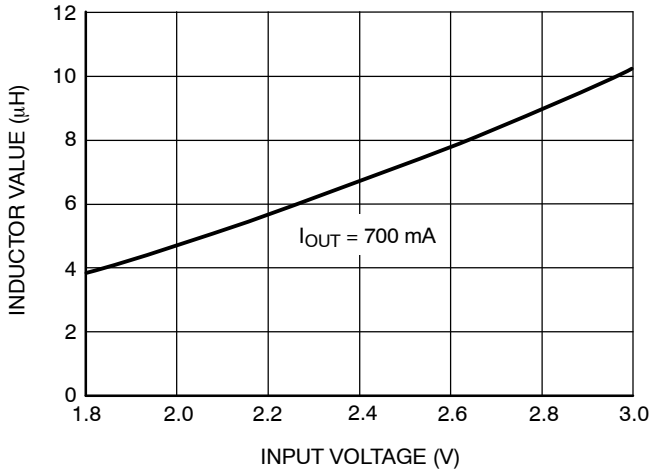

Figure 24. Suggested Inductance of $V_{OUT} = 3.3\text{ V}$

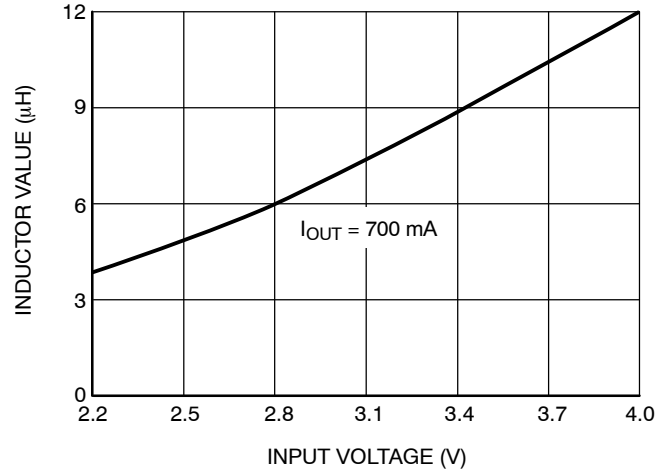

Figure 25. Suggested Inductance of $V_{OUT} = 5.0\text{ V}$

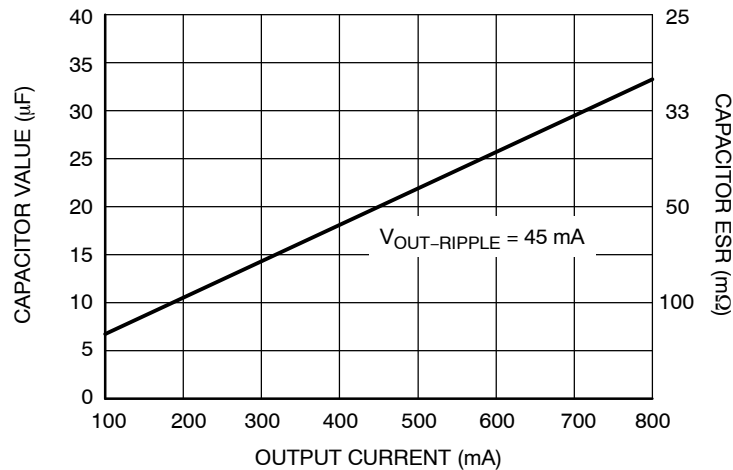

Figure 26. Suggested Capacitance for Output Capacitor

Table 1. Suggestions for Passive Components

Output Current	Inductors	Capacitors
800 mA	Sumida CR43, CR54, CDRH6D28 series	Panasonic ECJ series Kemet TL494 series
250 mA	Sumida CR32 series	Panasonic ECJ series Kemet TL494 series

MECHANICAL CASE OUTLINE PACKAGE DIMENSIONS



SCALE 2:1

DFN10, 3x3, 0.5P CASE 485C ISSUE F

DATE 16 DEC 2021

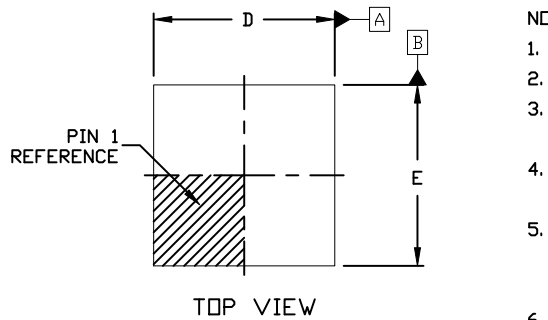

NOTES:

1. DIMENSION AND TOLERANCING PER ASME Y14.5, 2009.
2. CONTROLLING DIMENSION: MILLIMETERS
3. DIMENSION *b* APPLIES TO PLATED TERMINAL AND IS MEASURED BETWEEN 0.15 AND 0.30 MM FROM THE TERMINAL TIP.
4. COPLANARITY APPLIES TO THE EXPOSED PAD AS WELL AS THE TERMINALS.
5. TERMINAL *b* MAY HAVE MOLD COMPOUND MATERIAL ALONG SIDE EDGE. MOLD FLASH MAY NOT EXCEED 30 MICRONS ONTO BOTTOM SURFACE OF TERMINAL.
6. FOR DEVICE OPN CONTAINING W OPTION, DETAIL A AND DETAIL B ALTERNATE CONSTRUCTIONS ARE NOT APPLICABLE. WETTABLE FLANK CONSTRUCTION IS DETAIL B AS SHOWN ON SIDE VIEW OF PACKAGE.

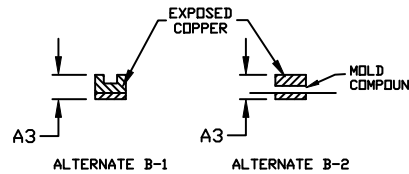
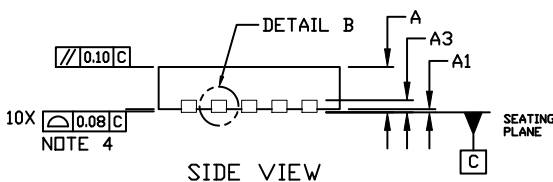

DIM	MILLIMETERS		
	MIN.	NOM.	MAX.
A	0.80	0.90	1.00
A1	0.00	---	0.05
A3	0.20 REF		
<i>b</i>	0.18	0.23	0.30
D	2.90	3.00	3.10
D2	2.40	2.50	2.60
E	2.90	3.00	3.10
E2	1.70	1.80	1.90
<i>e</i>	0.50 BSC		
K	0.20 REF		
L	0.30	0.40	0.50
L1	---	---	0.03

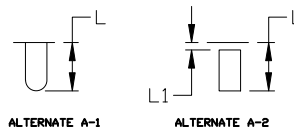
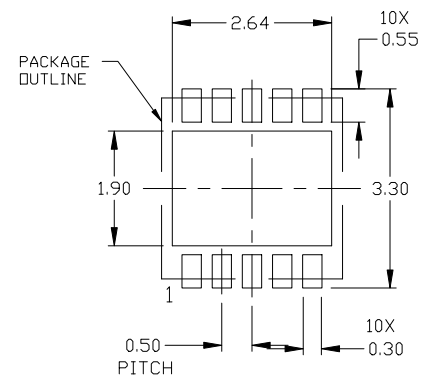
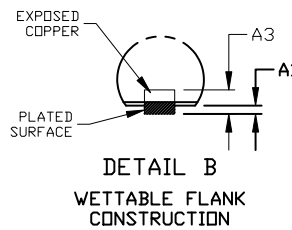
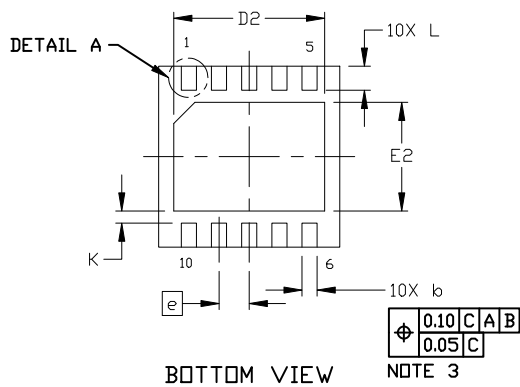

GENERIC MARKING DIAGRAM*

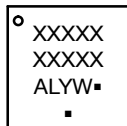

- XXXXX = Specific Device Code
- A = Assembly Location
- L = Wafer Lot
- Y = Year
- W = Work Week
- = Pb-Free Package

(Note: Microdot may be in either location)

*This information is generic. Please refer to device data sheet for actual part marking. Pb-Free indicator, "G" or microdot "▪", may or may not be present. Some products may not follow the Generic Marking.

RECOMMENDED MOUNTING FOOTPRINT

For additional information on our Pb-Free strategy and soldering details, please download the ON Semiconductor Soldering and Mounting Techniques Reference Manual, SOLDERRM/D.

DOCUMENT NUMBER:	98AON03161D	Electronic versions are uncontrolled except when accessed directly from the Document Repository. Printed versions are uncontrolled except when stamped "CONTROLLED COPY" in red.
DESCRIPTION:	DFN10, 3X3 MM, 0.5 MM PITCH	PAGE 1 OF 1

onsemi and ONSEMI are trademarks of Semiconductor Components Industries, LLC dba onsemi or its subsidiaries in the United States and/or other countries. onsemi reserves the right to make changes without further notice to any products herein. onsemi makes no warranty, representation or guarantee regarding the suitability of its products for any particular purpose, nor does onsemi assume any liability arising out of the application or use of any product or circuit, and specifically disclaims any and all liability, including without limitation special, consequential or incidental damages. onsemi does not convey any license under its patent rights nor the rights of others.

onsemi, **Onsemi**, and other names, marks, and brands are registered and/or common law trademarks of Semiconductor Components Industries, LLC dba "**onsemi**" or its affiliates and/or subsidiaries in the United States and/or other countries. **onsemi** owns the rights to a number of patents, trademarks, copyrights, trade secrets, and other intellectual property. A listing of **onsemi**'s product/patent coverage may be accessed at www.onsemi.com/site/pdf/Patent-Marking.pdf. **onsemi** reserves the right to make changes at any time to any products or information herein, without notice. The information herein is provided "as-is" and **onsemi** makes no warranty, representation or guarantee regarding the accuracy of the information, product features, availability, functionality, or suitability of its products for any particular purpose, nor does **onsemi** assume any liability arising out of the application or use of any product or circuit, and specifically disclaims any and all liability, including without limitation special, consequential or incidental damages. Buyer is responsible for its products and applications using **onsemi** products, including compliance with all laws, regulations and safety requirements or standards, regardless of any support or applications information provided by **onsemi**. "Typical" parameters which may be provided in **onsemi** data sheets and/or specifications can and do vary in different applications and actual performance may vary over time. All operating parameters, including "Typicals" must be validated for each customer application by customer's technical experts. **onsemi** does not convey any license under any of its intellectual property rights nor the rights of others. **onsemi** products are not designed, intended, or authorized for use as a critical component in life support systems or any FDA Class 3 medical devices or medical devices with a same or similar classification in a foreign jurisdiction or any devices intended for implantation in the human body. Should Buyer purchase or use **onsemi** products for any such unintended or unauthorized application, Buyer shall indemnify and hold **onsemi** and its officers, employees, subsidiaries, affiliates, and distributors harmless against all claims, costs, damages, and expenses, and reasonable attorney fees arising out of, directly or indirectly, any claim of personal injury or death associated with such unintended or unauthorized use, even if such claim alleges that **onsemi** was negligent regarding the design or manufacture of the part. **onsemi** is an Equal Opportunity/Affirmative Action Employer. This literature is subject to all applicable copyright laws and is not for resale in any manner.

PUBLICATION ORDERING INFORMATION

LITERATURE FULFILLMENT:

Email Requests to: orderlit@onsemi.com

onsemi Website: www.onsemi.com

TECHNICAL SUPPORT

North American Technical Support:

Voice Mail: 1 800-282-9855 Toll Free USA/Canada

Phone: 011 421 33 790 2910

Europe, Middle East and Africa Technical Support:

Phone: 00421 33 790 2910

For additional information, please contact your local Sales Representative